



HTS-720 Android Total Station
User Manual

Manual Revision

Revision Date	Revision Level	Description
Dec. 2022	1	HTS-720 Series User Manual Version 1.0

HTS-720

Android Total Station

User Manual



Preface

Instruction

Welcome to the Hi-Target HTS-720 Android Total Station. These instructions describe how to use this product.

Experience Requirements

To help you use the Hi-Target series of products better, Hi-Target suggests that you read the instructions carefully. If you are unfamiliar with the product, please refer to www.hi-target.com.cn

Tips for safe use



Notice: These are special operations and need your special attention. Please read them carefully.



Warning: The contents here are very important as the wrong operation may damage the machine. This can lead to the loss of data, or break the system and endanger your safety.

Exclusions

Before using the product, please read these operating instructions carefully, as they will help you to get the most from it. Hi-Target Surveying Instrument Co. Ltd assumes no responsibility if you fail to operate the product according to the instructions or operate it wrongly because you have misunderstood them.

Hi-Target is committed to constantly perfecting the product's functions and performance, improving its service quality, and reserves the right to change these operating instructions without notice.

We have checked the contents of the instructions and software and hardware but please note the possibility of deviation. The pictures in the operating instructions are for reference only and the actual products may

vary from them.

Technology and service

If you have any technical issues, please call the Hi-Target technology department for help, and we will answer any questions you have.

Relevant information

You can obtain this introduction by:

Purchasing Hi-Target products: this manual is found in the instrument container and will help you to operate the instrument.

Logging on to the Hi-Target official website and downloading the electronic version of this introduction from Partner Center: <http://members.hi-target.com.cn/>

Advice

If you have any suggestions for future developments to this product, please email them to: sales@hi-target.com.cn. Your feedback will help us to improve our products and services.



Contents

Preface	I
Instruction.....	I
Experience Requirements	I
Contents	II
Chapter 1.....	1
Overview	1
1.1 Foreword	2
1.2 Cautions	3
1.3 Security Guide.....	4
Chapter 2.....	6
Product introduction.....	6
2.1 Component Names.....	7
2.2 Keys Functions and Display Information.....	8
Chapter 3.....	10
Preparation before Measurement	10
3.1 Unpacking and Storage	11
3.2 Setting up the instrument.....	11
3.3 Loading and unloading of the battery.....	14
3.4 Reflecting Prism	15
3.5 Loading and unloading of the pedestal	15
3.6 Adjusting the eyepiece lens of the telescope and aiming at the target.	15
3.7 Entering letters and numbers.....	16
3.8 Notice for using U disk.....	19
3.9 Instrument Registration	19
3.10 Notes on Instrument Data Storage Size Prompt Messages	21
Chapter 4.....	22
Software Introduction and Operation	22
4.1 Software Introduction.....	23
4.2 Software Installation	23
4.3 Quick Start.....	23
4.3.2 Create Project.....	26

4.3.3 Example of setting up the station	26
4.3.4 Data Acquisition	27
4.3.5 Data Export.....	28
Chapter 5.....	31
Basic Measurements	31
5.1 Measure (Coordinate Measurement)	32
5.2 Point S.O (Coordinate Stakeout)	35
Chapter 6.....	37
Set up Station.....	37
6.1 STN Setup (Orientation with Backsight).....	38
6.1.1 By known PT.....	39
6.1.2 Azimuthal Orientation	40
6.1.3 Without CP.....	41
6.1.4 Free Station	42
6.2 BS Check	42
6.3 Resection	43
6.4 Elevation Transfer.....	46
6.5 Point to Line	49
Chapter 7.....	52
Collection Program	52
7.1 Measure (Coordinate Measurement)	53
7.2 Dist. Offset.....	53
7.3 Plane Offset.....	54
7.4 Column Offset	55
7.5 MLM	57
7.6 REM	60
7.6.1 Ground REM.....	60
7.6.2 Reference Point REM	61
7.7 Line & Extension Point	62
7.8 Line & Angle	64
Chapter 8.....	67
Stakeout program.....	67
8.1 CAD.....	68
8.1.1 CAD Data Import.....	68

8.1.2 Layer Display	68
8.1.3 Delete Base Map	69
8.1.4 Open the Last Base Map	70
8.1.5 CAD Stakeout Tool.....	71
8.1.6 Line stakeout	71
8.1.7 CAD Point Stakeout	73
8.2 Point S.O	74
8.3 Image	76
8.4 Angle&Dist.....	78
8.5 Directional Line.....	80
8.6 Straight Line	81
8.7 RefLine.....	83
8.7.1 Reference Line Definition	83
8.7.2 Reference Line Stakeout.....	84
8.8 RefArc	86
8.8.1 Reference Arc Definition	86
8.8.2 Reference Arc Stakeout	87
Chapter 9.....	94
COGO	94
9.1 Without CP correction.....	95
9.2 Free Station Calibration	96
9.2.1 Known Point Method	96
9.2.2 Common Point Method	98
9.3 Calculator	101
9.4 Calc. XYZ	101
9.5 Inverse	102
9.6 Area&Girth.....	103
9.7 Angle Conversion	105
9.8 Dist. Conversion	105
9.9 Average	106
9.10 Transition curve	107
9.11 Equidistant Point.....	109
Chapter 10.....	110
Project.....	110

10.1 Project	111
10.2 Point Library	112
10.2.1 All Points	114
10.2.2 Measurement Points	116
10.2.3 Stakeout Point.....	117
10.2.4 Control Points	120
10.3 Ground Code.....	120
Chapter 11	125
Road.....	125
11.1 Road Design.....	126
11.1.1 Broken Chainage.....	126
11.1.2 Flat Section Design Line.....	128
11.1.3 Longitudinal Section Design Line	134
11.1.4 Cross-sectional Design Line.....	134
Chapter 12.....	142
Bridge.....	142
12.1 Pie Design.....	143
12.2 Bridge Design.....	146
12.3 Cone Design.....	148
12.4 Pier Stakeout.....	150
12.5 Conical Slope S.O	153
Chapter 13.....	157
Tunnel	157
13.1 Tunnel Section Library	158
13.2 Tunnel Feature Points	163
13.3 Tunnel Over-under-excavation.....	164
Chapter 14.....	168
Configuration	168
14.1 Distance	169
14.1.1 EDM Mode.....	169
14.1.2 Prism Constant	170
14.1.3 Reflector	170
14.1.4 PPM (Atmospheric correction)	170
14.1.5 Grid Factor.....	171

14.1.6 Atmospheric Refraction Coefficient	172
14.2 Other	172
14.2.1 Distance Measurement Beep	173
14.2.2 Key Tone	173
14.2.3 Screen Display	173
14.2.4 Laser Pointing	174
14.2.5 Signal Strength	174
14.2.6 Baud Rate	174
14.3 Meas. Auxiliary	174
14.3.1 Shortcut Meas. Key	174
14.3.2 Pt Name Increment	175
14.3.3 Note	175
14.3.4 Rename tips	175
14.4 Unit & Display	175
14.4.1 Angle	176
14.4.2 Distance	176
14.4.3 Temperature Units	176
14.4.4 Pressure Unit	177
14.4.5 HA	177
14.4.6 VA	178
14.4.7 Min. Reading	178
14.4.8 Distance Decimal	179
14.4.9 Coord. type	179
14.4.10 Soft-Keypad	180
14.5 Calibration	180
14.6 Info	181
Chapter 15	183
Quick Menu	183
15.1 Laser Plummet	184
15.2 PPM	184
15.3 Prism Constant	185
15.4 Reticle Backlight	185
15.5 Function Key	185
15.6 FTP	186

15.7 Register TS	187
Chapter 16.....	188
Top Shortcut Function.....	188
16.1 Dist Mode(distance measurement)	189
16.2 Tilt Compensation.....	189
16.3 Reflector Type Switching	190
16.4 Laser Pointing	190
16.5 Point Data.....	190
16.6 More	190
16.6.1 Distance.....	190
16.6.2 Meas. Auxiliary.....	191
16.6.3 About	191
16.6.4 Exit.....	191
Chapter 17.....	192
Inspection and Calibration	192
17.1 Tube Level.....	193
17.1.1 Check.....	193
17.1.2 Adjust.....	193
17.2 Round Level	193
17.2.1 Check.....	193
17.2.2 Adjust.....	193
17.3 Telescope Reticle	194
17.3.1 Check.....	194
17.3.2 Adjust.....	194
17.4 Perpendicularity of the Visualization Axis to the Horizontal Axis.....	195
17.4.1 Check.....	195
17.4.2 Adjust.....	196
17.5 Vertical Index Spread and Vertical Index Zero Setting	197
17.5.1 Check.....	197
17.5.2 Adjust.....	197
17.6 Vertical Index Difference (i-angle) and Vertical Index Zero Point Setting.....	197
17.6.1 Check.....	197
17.7 Laser Plummet	199
17.7.1 Check.....	199

17.7.2 Adjust.....	200
17.8 Instrumentation Plus Constant (K).....	201
17.8.1 Check.....	201
17.8.2 Adjust.....	201
17.9 The parallelism between the Axis of Visual Alignment and the Axis of Emitting Electric Light	202
17.9.1 Check.....	202
17.9.2 Adjust.....	202
17.10 Non-prism Distance Measurement.....	202
17.10.1 Check.....	203
Appendix A Symbol Meaning	204



Chapter 1

Overview

This chapter contains:

- Foreword
- Cautions
- Security Guide



Hi-Target

1.1 Foreword

This HTS-720 Total Stations is based on the Android hardware platform, Supports angle measurement, distance measurement, key light, serial port, Bluetooth, Wi-Fi, USB, automatic tilt compensation, high centering, key tone, support installation of GNSS equipment at the same point, support total station command communication protocol, with powerful industry application software, including project management, station setting, basic measurement, program measurement, road stakeout, bridge, tunnel, map, configuration. At the same time, it can be installed on the handheld mobile terminal for use, and the Wi-Fi can be connected to the total station for remote control measurement, which is suitable for various professional measurements.

1. Absolute coded dial

With an absolute digital dial, instruments can be measured directly when it powers on. The measured azimuth angle result will not be lost even when the instrument shut off.

2. Powerful memory management

Large-capacity memory, easy to manage the file system, serving to add, delete and transfer data.

3. No prism distance measurement

The series Total Station with laser distance measurement No-Prism is capable of surveying for long distances, fast and precise measurements with various materials and different colors of objects (such as building walls, poles, wires, cliff walls, mountains, mud, stakes, etc.). For those who are hard or impossible to be reached, the application of Prism features can be a good measurement task.

4. Special measurement program

The series total station is equipped with the basic surveying function as well as special measurement programs, undertaking REM, offset measuring, stakeout, Resection, area measurement and calculation, road design, etc. to meet the needs of professional measurement.

5. Eyepiece changeable

The instruments' eyepiece can be changed, and equipped with a diagonal eyepiece, serving to observe zenith and high buildings.

6. An optional laser plummet

The site features are easy to instruct and set up stations.

7. Image assisted stakeout

The instrument has the image-assisted stakeout function, which can display the stakeout point mark on the software interface, which is convenient for aiming at the stakeout point.

1.2 Cautions

1. Avoid looking directly into the sun with the eyepiece when measuring. Recommended to use a solar filter to reduce the impact.
2. Avoid extreme temperatures when storing equipment and sudden changes in temperature when using the instrument.
3. The instrument should be loaded in the box placed in a dry and ventilated place and prevented from shock, dust, and moisture when it is not in use.
4. To get good accuracy, you should leave the instrument in the box if the instrument temperature has a large difference between working and storing you may unpack the box and employ the instrument until the instrument reaches the temperature at the working field.
5. If the instrument is not used for a long time, the battery should be unloaded and stored separately and charged once a month to prolong battery life.
6. The instrument should be installed in the box when it is transported. Extrusion, collision, and violent vibration need to be carefully avoided during the transport process. The soft mat May be placed around the box on long-distance transportation.
7. It is better to use a high-quality wooden footstool to make sure the stability of measurement and improve its accuracy when setting up the instrument.
8. Only use absorbent cotton or lens paper to wipe the instrument gently if the exposed optical device needs to be cleaned.
9. Use a flannelette or a hairbrush to clean the instrument after use. Do not electrify and start up after the device got wet in the rain. Using a clean soft cloth to wipe it dry and put it in a ventilated place for some time to make the instrument fully dry before using or packing.
10. Inspect the instrument carefully and comprehensively to ensure its indicators, function, power supply, the initial setting, and correction parameters meet the requirements before operating.
11. If the function is abnormal, non-professional maintenance persons are not allowed to dismantle the device without authorization in case of any unnecessary damage.

12. The emitted light of the no-prism total station is a laser, do not direct to the eyes.



Note: This instrument is subject to strict inspection and calibration at the factory, and the quality meets the standard requirements. But the instrument after long-distance transport or environmental changes, the instrument's optical and mechanical structure parameters of trace changes are inevitable. Therefore, the new purchase of this instrument and the measurement area before the operation of the instrument should be carried out in this section of the inspection and calibration to ensure the accuracy of the results of the operation.

1.3 Security Guide

Pay attention to the following safety matters when you use the laser distance measurement non-prism.

Warning:

Total station fit out laser level 3R/IIIa which is recognized by the loge, which is above: the vertical locking screw saying: "3A laser product ". This product belongs to Class 3R level laser. According to the following standards IEC 60825-1: 2001 Class 3R/IIIa laser product can reach five times of emission limits of the Class 2/ II in the wavelength between 400nm-700nm.

Warning:

Continuous staring into the laser beam is harmful.

Prevention:

Do not stare at the laser beam or point to others. The reflected beams are the effective signal of the instrument. It's safe to observe by an eyepiece.

Warning:

When the laser beam is irradiated and reflected by prisms, plane mirrors, the surface of the metal, and windows, it's dangerous to look straight into the reflected beams.

Prevention:

Don't stare at the reflected beams. When the laser is switched on (distance mode), do not obstruct the optical path or stand near the prism. Target at a prism with a total station telescope only.

Warning:

It's dangerous to use the Class 3R laser device improperly.

Prevention:

To avoid injury, each user must carry safety prevention measures and operate the instrument within the safety scope according to standard IEC60825-1: 2001).

The following is the explanation of the main part of the standard:

Class 3R level laser products are used outdoors and in construction (surveying with No-Prism).

A: Only trained and certified persons are allowed to install, adjust and operate the laser equipment.

B: Set up appropriate laser warning signs within the operating field

C: To prevent anyone from looking into the laser beam use an optical instrument to observe.

D: To prevent laser damage to persons, the laser beams should be blocked at the end of the working route, and should be cut off when people work in the restricted area (harmful distance) where laser beams crossing are harmful.

E: The route of the laser beam must be set to be higher or lower than the human eye.

F: Properly store and safe keep the laser products when they are not in use, unauthenticated personnel are not allowed to use them.

G: Do not point laser beams at surfaces such as plane mirrors, metal surfaces, or windows, especially the surface of plane mirrors and concave mirrors.

Harmful Distance is the maximum distance from the starting point of the laser beams to where people are right safe. The built-in harmful distance of the Class 3R/IIIa laser is 1000m(3300ft) and the laser intensity will reduce to that of Class 1 products (which does not harm eyes) if people are out of this range.

Chapter 2

Product introduction

This chapter contains:

- Component Names
- Keyboard Functions and Display Information



Hi-Target

2.1 Component Names

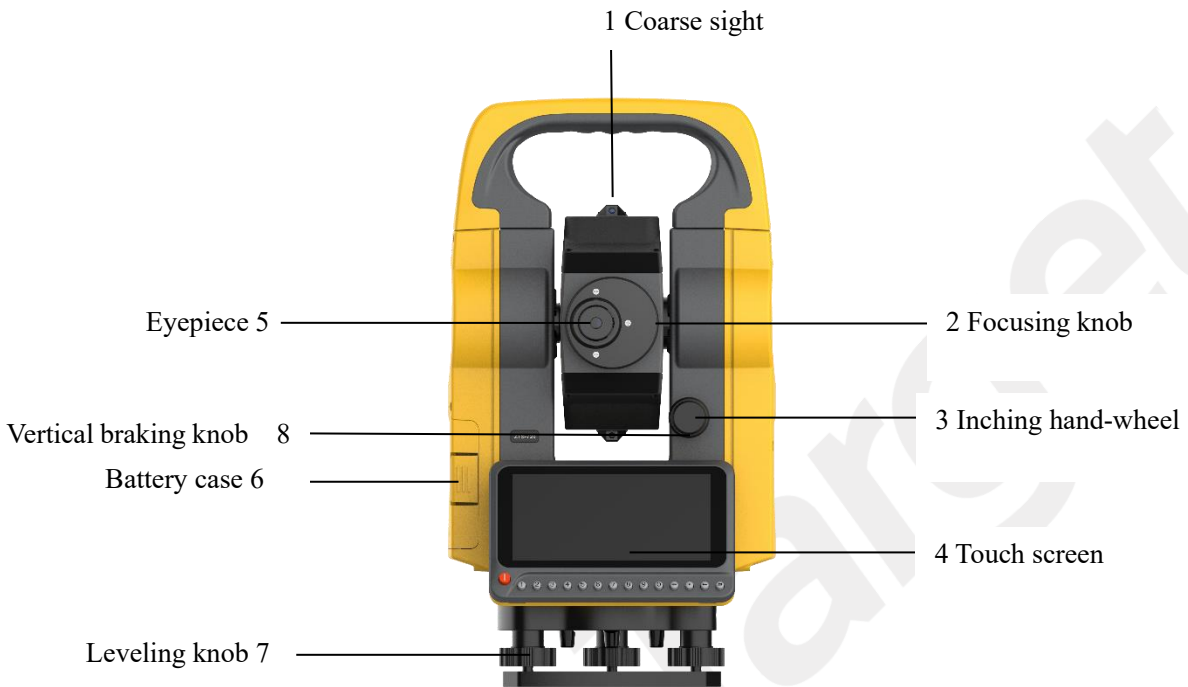

Figure 2-1



Figure 2-2

2.2 Keys Functions and Display Information



Figure 2-3

Table 2.1 Key functions



Key	Name	Function
	Shortcut Measurement Key	Trigger a measurement when clicked.
	Power Key	Power ON/ Power OFF.
0 ~ 9	Number Key	Enter the number 0~9.
. ~ -	Symbol Key	Enter the symbol, decimal point, plus or minus sign.
←	Delete Key	Delete the previous character of the insertion character.
↵	Return Key	Return to the previous level.

Table 2.2 Display symbol definitions

Symbols	Content
Vz	Zenith Mode
V0	The vertical angle is displayed as 0 when the telescope is horizontal at the face of 1
Vh	Vertical angle Mode (it is 0°00'00" when the telescope is level. The angle of elevation is positive and the angle of depression is negative)
V%	Slope Mode
HR	Horizontal angle (right angle). dHR means the angle difference

HL	Horizontal angle (left angle)
HD	Horizontal distance. dHD is to stake out differences in horizontal distance
VD	Elevation difference. dVD is to stake out differences in elevation
SD	Slope distance. dSD is to stake out differences between slope distances
N	North coordinates, dN is to stake out differences between north-coordinates
E	Eastern coordinates, dE is to stake out differences between East-coordinates
Z	Elevation coordinates, dZ is to stake out differences between Z-coordinates
m	Unit in meters (metric units)
ft	Units in feet (imperial)
fi	In feet and inches, feet before the decimal point and hundredths of an inch after the decimal point
X	The value along the baseline direction in point projection measurement, the direction from the starting point to the endpoint is positive
Y	Point projection measurement of values in the direction of vertical deviation from the baseline
Z	Elevation of the target in point projection measurement



Chapter 3

Preparation before Measurement

This chapter contains:

- Unpacking and Storage
- Placement of Instruments
- Battery Loading and Unloading, Information and Charging
- Reflective Prisms
- Loading and Unloading of Bases
- Telescope Eyepiece Adjustment and Target Illumination
- Alphanumeric Input Method
- Notes on USB Flash Drives
- Instrument Registration
- Notes on Instrument Data Storage Size Prompt Messages

3.1 Unpacking and Storage

- Unpacking

Lay the box gently down with the top side facing up. Open the lock and take out the instrument.

- Storage

Cover the telescope with its cover. Make sure that the vertical clamping screw and the level bubble are facing upwards. Lay the instrument down in the box with the objective lens of the telescope facing downwards. Tighten the vertical clamping screw gently before covering and locking the box.

3.2 Setting up the instrument

- Reference for operation.

Attach the instrument to the tripod gently, then level and center it to ensure the accuracy of the measurement result. (A special tripod with a central connecting spiral should be used).

Using plummets to center and level

1) Establish the tripod Set up the tripod

- ① First open the tripod, so that the tripod's three legs are approximately equidistant, and make the top surface approximately horizontal, tighten the three fixed screws.
- ② Make sure that the center of the tripod top is right above the station;
- ③ Stamp the tripod on the ground with your feet.

2) Attach the instrument to the tripod

Install the instrument by mounting it on the tripod head. Support it with one hand, and tighten the centering screw on the bottom of the unit to make sure it is secured to the tripod.

3) Using the circular level to level the instrument coarsely

- ① Twist and adjust the two leveling screws, A and B, on the bottom of the instrument until the bubbles of the circular level move to the line perpendicular to the center line of screws A and B.
- ② Twist and adjust leveling screw C to move the bubble to the center of the circular level.

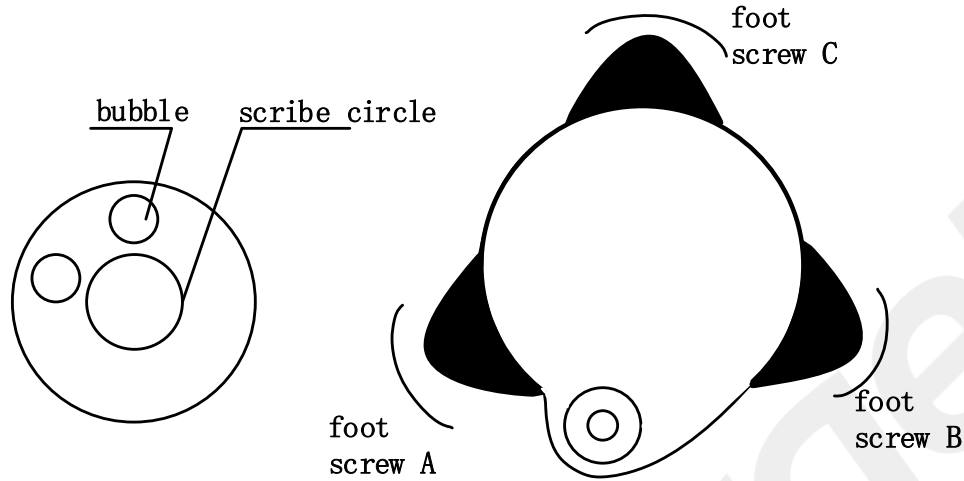

Figure 3-1

4) Using the plate level to level the instrument precisely

- ① Loosen the horizontal locking screw and turn the instrument around until the plate level is perpendicular to a line defined by screws A and B. Adjust screws A and B to position the bubble in the center of the level.

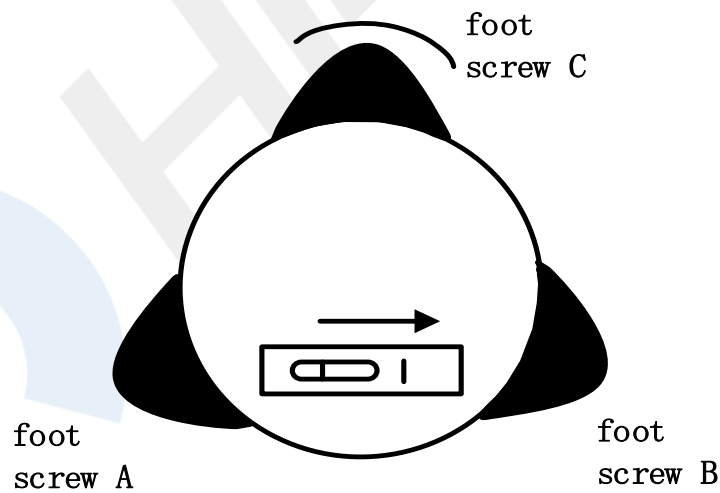

Figure 3-2

- ② Turn the instrument approximately 90° and adjust screw C until the bubble is in the center of the level.

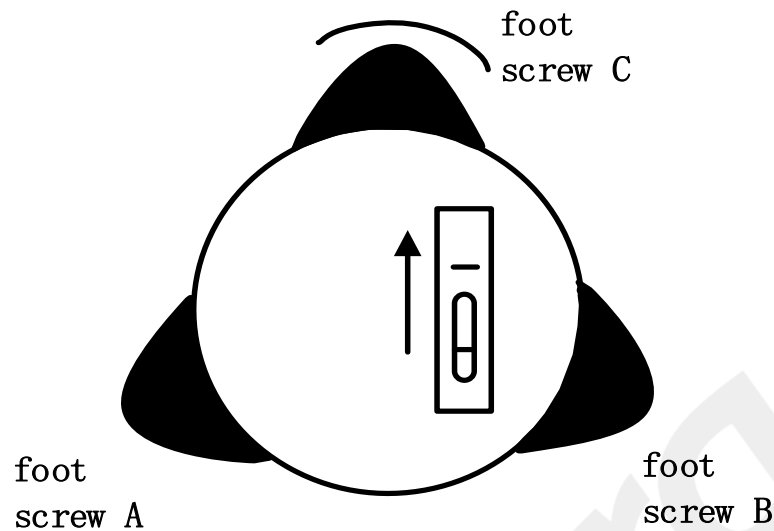

Figure 3-3

③ Turn around the instrument 90° again. Repeat the above steps until the bubble remains in the center of the plate level even when the instrument is rotated to any position.

Using a centering device to center

1) Set up the tripod

Open the tripod and make sure that the three feet of the tripod are approximately equal in distance from the center and that the top is level. Tighten the three locking screws. Make sure that the center of the top of the tripod is right above the station. Stamp one foot on the ground with your feet.

2) Install the instrument and counterpoints

Place the instrument carefully on the tripod, tighten the center connecting screw, and adjust the optical pointing device until the cross-wire imaging is clear (if it is a laser plummet device, then open the laser plummet device in the compensation interface).

Hold the other two unfixed legs of the rack with both hands and adjust their position by observing the optical pointing device. When the pointing device is roughly aligned with the survey site, fix all three legs of the tripod to the ground. Adjust the three leg screws of the total station to align the pointing device precisely with the survey site.

3) Using a circular level to level the instrument coarsely

Adjust the length of the three legs of the tripod so that the total station round-level bubble is centered.

4) Using the tubular level to level the instrument precisely

- ① Loosen the horizontal brake screw and turn the instrument so that the tube level is parallel to the line of foot spirals A and B. By rotating foot spirals A and B, center the bubble of the tube level.
- ② Rotate the instrument 90 so that it is perpendicular to the line of foot spirals A and B. Rotate foot C to center the tube leveler bubble.

5) Precise centering and leveling

Looking at the center observation device, loosen the connection screw slightly and shift the instrument horizontally (do not turn the instrument around) until the instrument aims at the station precisely. Tighten the center connecting screw again to precisely level the instrument. Repeat the steps above until the instrument aims at the station precisely.

3.3 Loading and unloading of the battery

Battery Information

- Full battery, operation is available.
- When this first appears the battery can support the instrument for another 4 hours.
- The battery is low and should be replaced. If you are unsure of the time you will need the instrument to operate, it is a good idea to prepare a spare battery in advance so you can carry on working.
- The battery can last only a few minutes more, you should immediately replace the battery.

Notes:

- ① The time a battery can power the instrument will be affected by many factors, such as the ambient temperature, recharging time, and recharging and discharging times. To be on the safe side we suggest you recharge the battery fully or prepare several full batteries before operation.
- ② The battery symbol only indicates power capability for the current measurement mode. The power consumption in distance measurement mode is higher than when in angle mode, if the instrument enters into distance measurement mode from angle mode, the instrument may be automatically shut down because of limited power.

Notes for loading/ unloading batteries:

- ▲ You should switch off the instrument before removing the battery

▲ To install the battery, press the top button of the battery compartment to snap it into the instrument and secure it into place.

Notes for charging:

▲ Though the charger is designed with an overcharge protection circuit, we recommend unplugging the charger after charging has finished.

▲ The suitable temperature range for charging is between 0°C and +45°C. Charging may be abnormal if attempted outside this range.

▲ A battery can be recharged between 300-500 times. Fully discharging the battery will shorten its service life.

▲ To get the maximum life out of the battery, please make sure to charge it once a month even if the instrument has not been in use for a long time.

3.4 Reflecting Prism

When measuring the distance with the prism mode, a reflecting prism must be positioned at the target site. Reflective prisms are available in single, or triple, sets, which can be attached to a tripod via a base connector, or directly to a centering rod. Prism sets can be configured by the user according to operational needs.

3.5 Loading and unloading of the pedestal

Unloading

If necessary, the triAngle base can be removed from the instrument (including the reflecting prism base connector) by loosening the base locking fixing screw with a screwdriver and then turning the locking knob about 180° counterclockwise to separate the instrument from the base.

Loading

Put the three feet on the instrument into the holes of the triAngle base, turn the locking knob 180° clockwise to lock the instrument to the base, and then use a screwdriver to turn the locking knob fixing screw to the left.

3.6 Adjusting the eyepiece lens of the telescope and aiming at the target.

How to aim at targets (for reference)

① Aim at the bright sky with the telescope and adjust the eyepiece to focus until a sharp image of the

cross wire forms; (rotate the eyepiece barrel in your direction before slowly spinning in to focus the clear cross wire).

- ② Aim at the target with the cross center in the coarse sighting device on the top of the lens. Your eyes should keep a distance of about 200 mm away from the sighting device.
- ③ Use the telescopic focusing screw to make the target image clear.

When the eye moves up and down or left and right at the end of the eyepiece to find parallax, it means that the focus or eyepiece diopter is not well adjusted. This will affect the accuracy of angle measurement. Carefully focus and adjust the eyepiece tube to eliminate parallax.

3.7 Entering letters and numbers

The keyboard of this series total station comes with both character and numeric keys, so users can directly input numbers and characters.

Enter letters

[Example 1] Entering a file name in the surveying mode, for example, in which we input the filename "SUN1A" into the edit box.

Click on the software [Project] > [New Project] "+" and click on the project name input box.

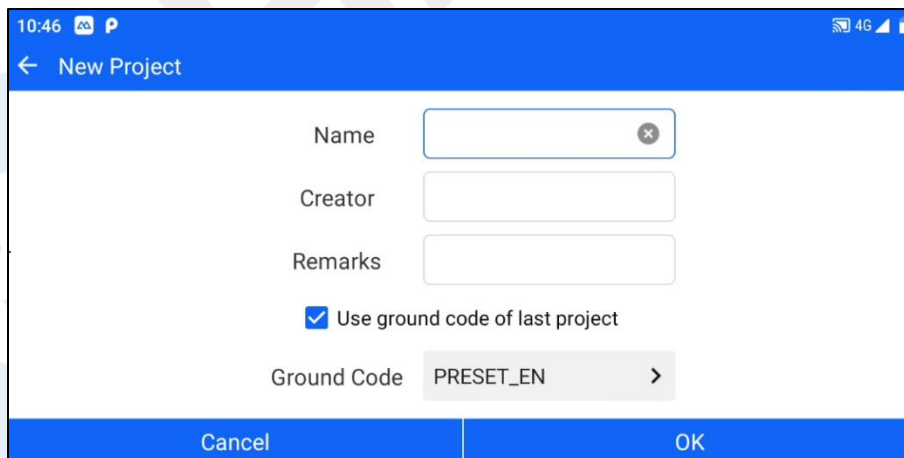

Figure 3-4

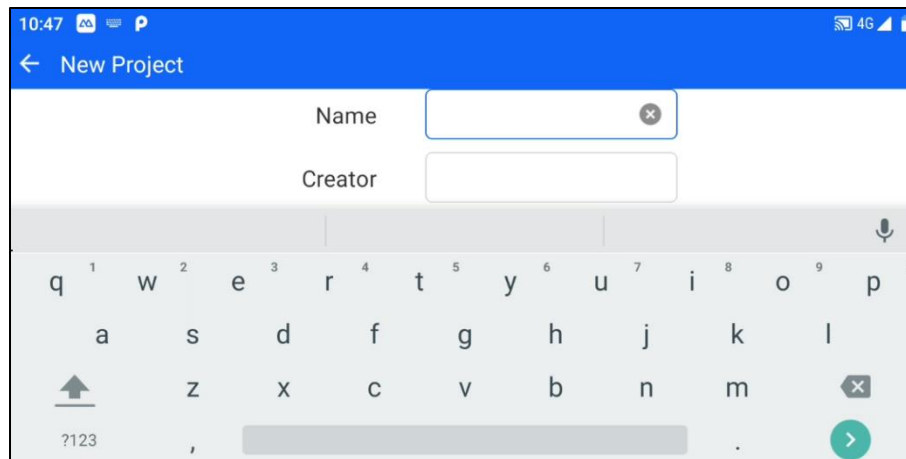

Figure 3-5

Simply type SUN1A on the soft keyboard that pops up.

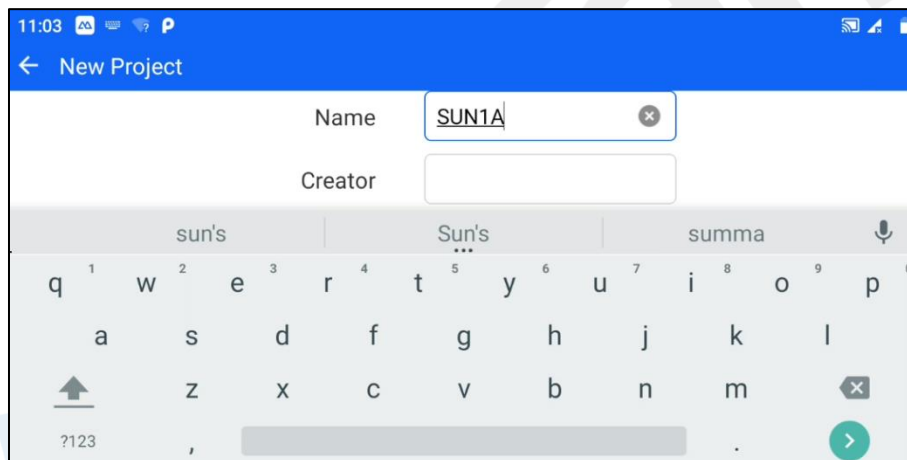

Figure 3-6

***Enter numbers**

[Example 2] Select the station setting mode, click on the "+" sign in the station interface, enter the coordinates of the station, click on the [N] direction input box, enter: -123.456

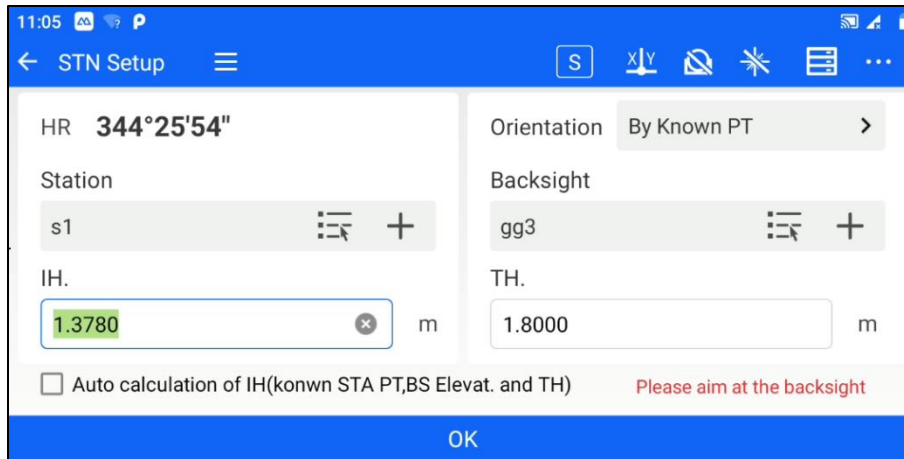

Figure 3-7

Method 1

The key sequence at the bottom of the screen: [-]→[1]→[2]→[3]→[.]→[4]→[5]→[6]

The results are shown in the following figure.

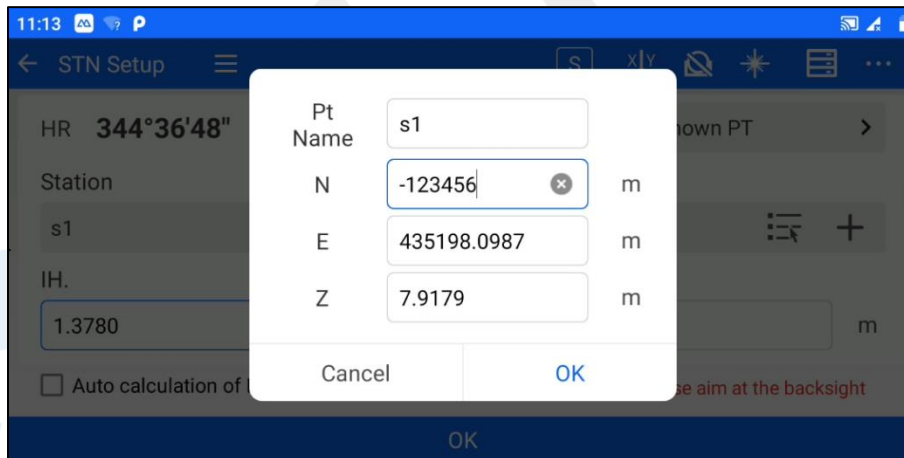

Figure 3-8

Method 2

In the pop-up soft keyboard key sequence: [-]→[1]→[2]→[3]→[.] →[4]→[5]→[6]

The results are shown in the following figure.

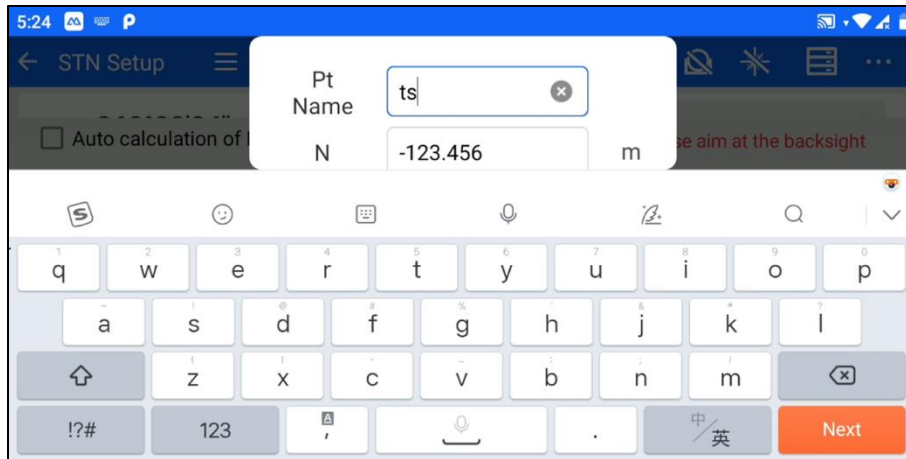

Figure 3-9

3.8 Notice for using U disk

This machine supports a maximum of USB2.0/2.1/3.0/3.1 128G USB flash drive reading and writing, **when running the program, don't insert or pull out the U disk. If you do so when the instrument is in use, the action may cause an error!**

3.9 Instrument Registration

No distance measurement operation can be performed before the instrument has been registered.

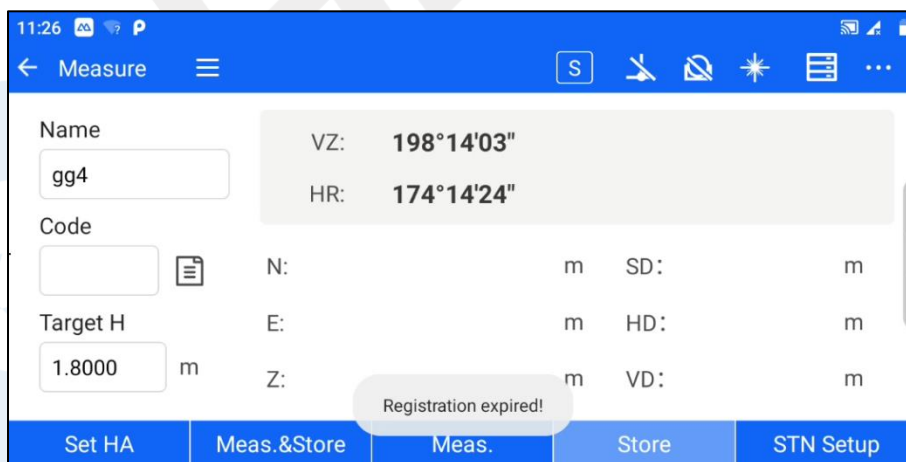

Figure 3-10

- 1) For instrument registration, you can click [Info.] in the main interface configuration options or click [Register TS] in the main interface shortcut menu to enter the instrument registration interface.

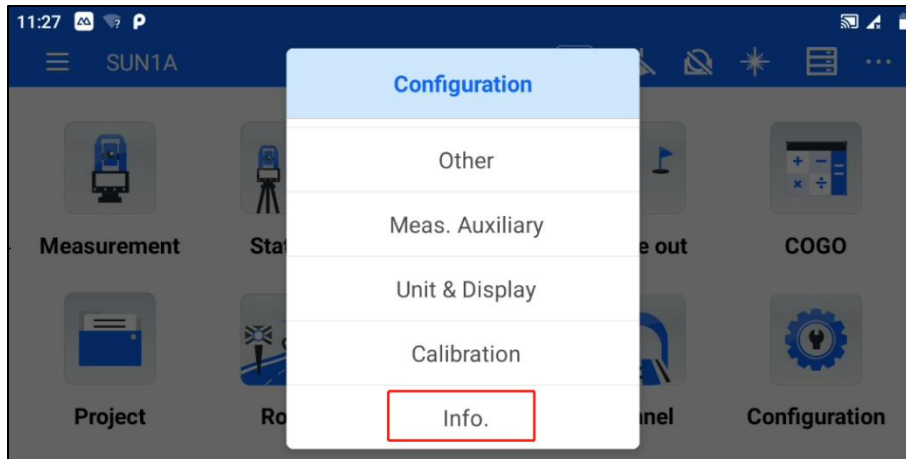

Figure 3-11

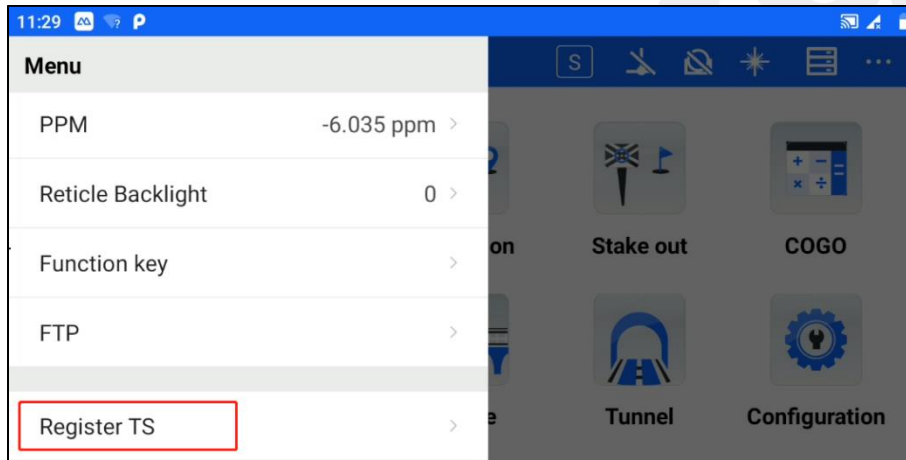

Figure 3-12

- 2) Enter the Total Station information interface, click [REGISTER], and enter the correct registration code in the pop-up input box (please contact your dealer to obtain it).

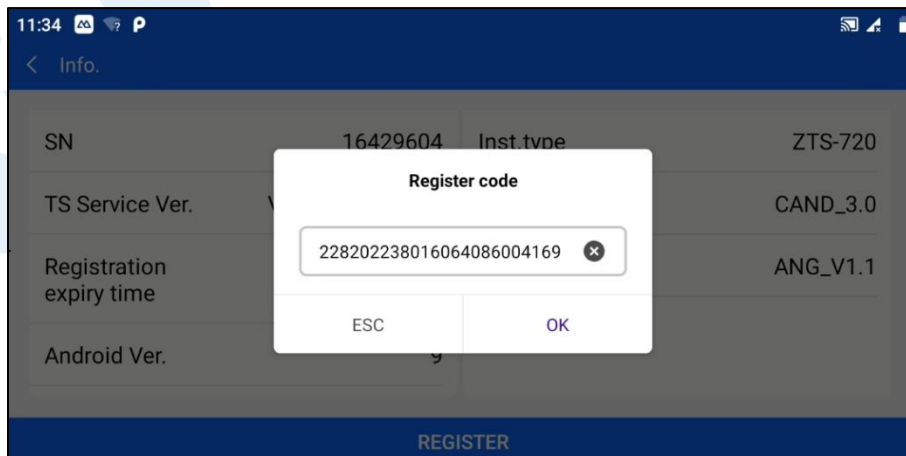

Figure 3-13

- 3) After entering the correct registration code, press the [OK], indicate that the registration is successful and the displayed registration expiration time is shown correctly.

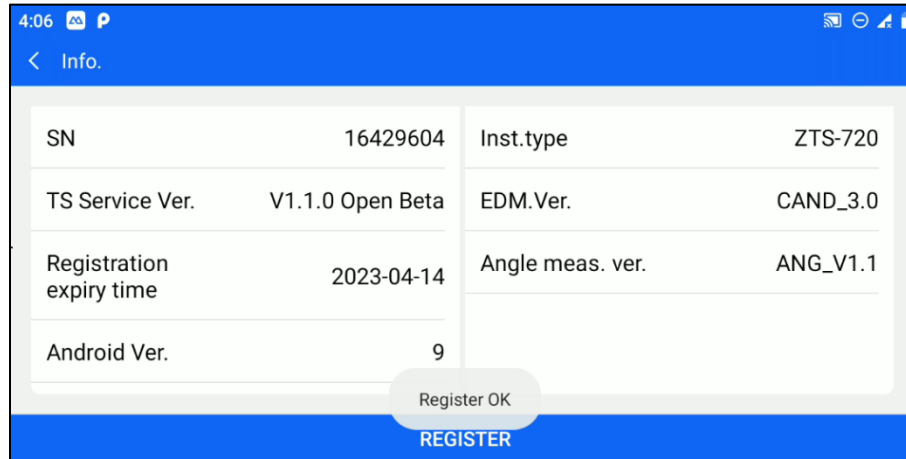

Figure 3-14

3.10 Notes on Instrument Data Storage Size Prompt Messages

When the amount of free memory in the instrument is less than 100k, the prompt "Disk is below 100K, please organize data or delete data" will appear after powering on.



Note: When deleting disk data, please export your measurement data to the U disk first to prevent unnecessary trouble arising from lost data.

Chapter 4

Software Introduction and Operation

This chapter contains:

- Software Introduction
- Software Installation
- Quick Start



Hi-Target

4.1 Software Introduction

T-Survey is a total station software developed by Hi-Target. In addition to the basic station setting and surveying functions, it also supports a variety of stakeout programs, including CAD stakeout and Image-Assisted stakeout. The software also supports road, bridge, and tunnel-related design and stakeout operations.

4.2 Software Installation

T-Survey should be run on Android 9 or above operating system. It can run on Android devices such as Hi-Target professional Android total station, professional survey handbook, and ordinary cell phones. It can be installed by copying the T-Survey apk(Android Package) to the Android terminal device or using a third-party software for installation via the computer.

4.3 Quick Start

The following is only a quick start program, please refer to the detailed instructions in each chapter for detailed usage steps. This program is only a solution that we provide to you, and you may not follow this program after you have become proficient in using the software. During the operation, the usual program is:

4.3.1 Initial Settings

Open T-Survey, the main interface of the software is as follows.

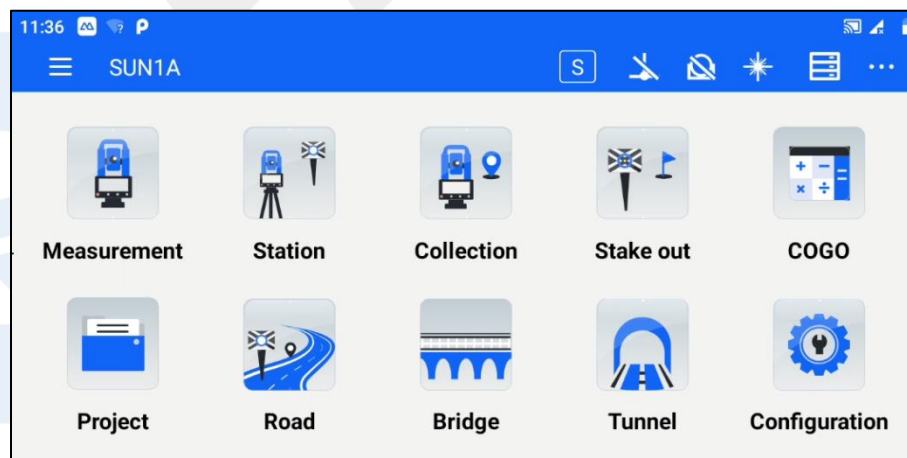

Figure 4-1

a. Set up the tilt correction of horizontal and vertical angles

Our series total station can correct the error of the vertical angle reading caused by a tilt in the direction of the X-axis and Y-axis. The compensation mode includes XY dual-axis compensation, X single-axis

compensation, and close compensation.



Users can choose whether to turn on the tilt compensation or not according to the actual operation scenario. To ensure the accuracy of the angle measurement, it is recommended not to turn off the tilt compensation, whose display can also be used to better level the instrument. If the "compensation over the limit" appears, it indicates that the instrument is out of the range of automatic compensation, and the foot screw must be adjusted for leveling.

b. Set up the Target Type

Our series total station has three reflectors that can be selected, prism, non-prism (NP), and sheet(reflect sheet), users can set them according to their operational needs.



Figure 4-2

c. Set up the Atmospheric Correction

When measuring distance, the measured value will be affected by the atmosphere. To reduce this, atmospheric correction parameters are needed.

Click the upper left button to open the [Menu] bar and click [PPM] to set it.

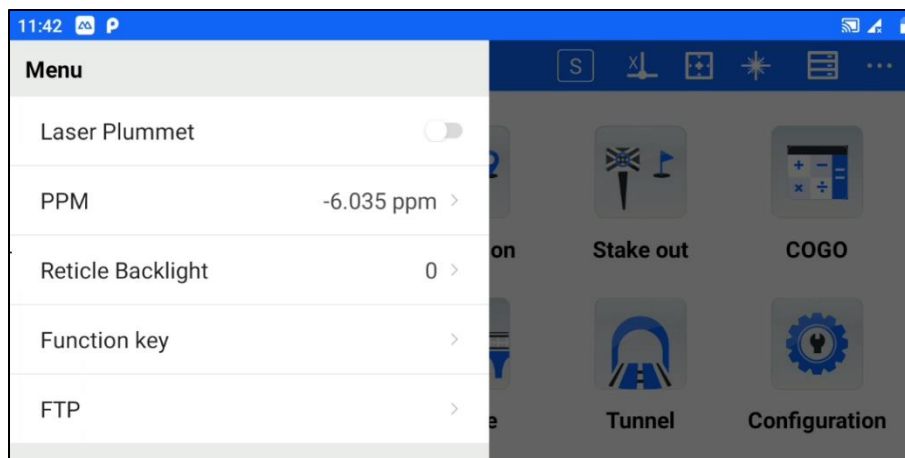

Figure 4-3

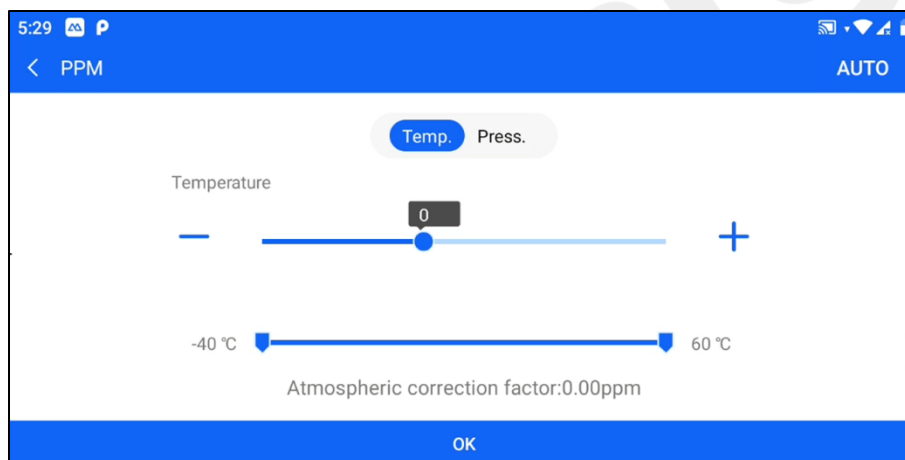

Figure 4-4

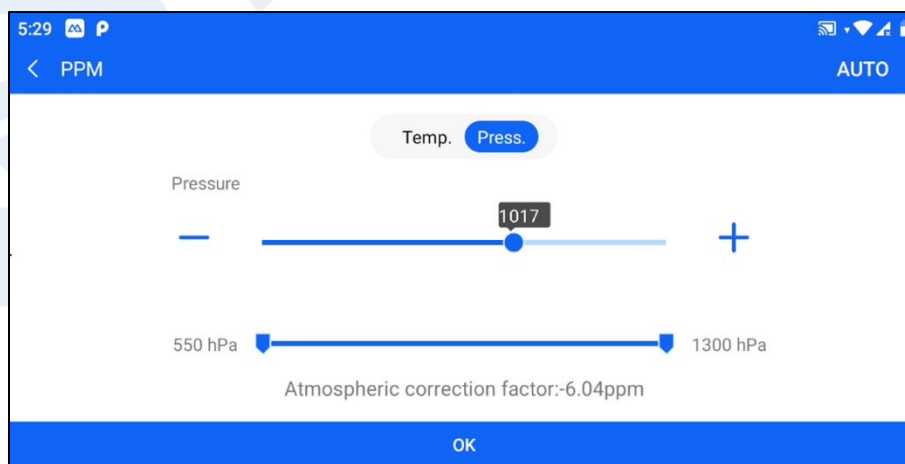

Figure 4-5

4.3.2 Create Project

To create a new project, click [Project], click the blue hover [+] button on the interface (button can be dragged), enter the project name (required), Creator, Remarks, and other information, select Ground Code template, confirm that there are no errors and click [OK] to complete the new project.

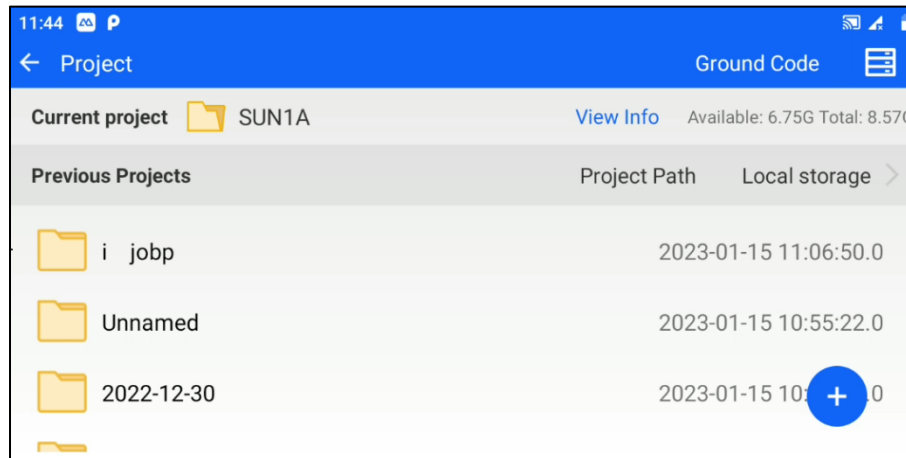

Figure 4-6

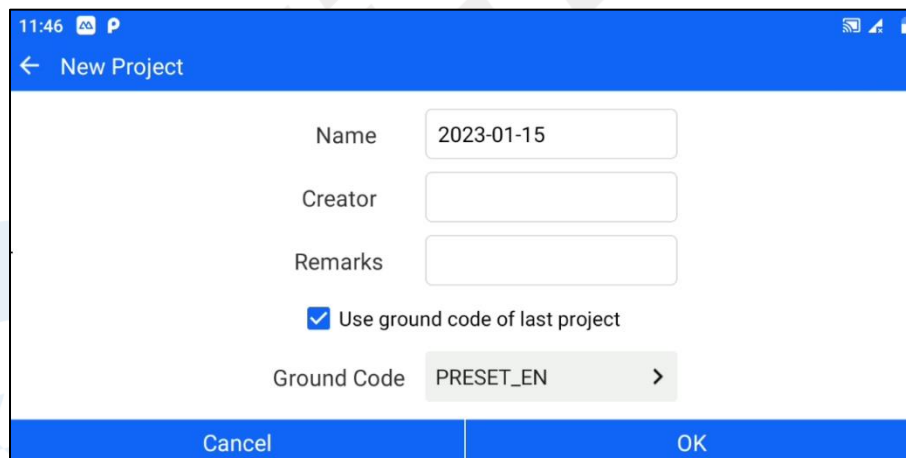

Figure 4-7

4.3.3 Example of setting up the station

The software supports users to set up stations by Backsight Orientation, Elevation Transfer, Resection, and Point to Line. Here is an example of setting up a station by Known Point.

1. The total station is set up on the known point A and aimed at the known point B.

2. Click [Station] - [STN Setup], and choose "By Known PT" as the orientation method. Set the coordinates of known point A for the station, set the coordinates of known point B for the backsight point, and enter the instrument height and target height correctly.

3. Click "OK" after aligning the backsight point, a measurement difference check box will pop up. If the difference value is within the acceptable range, click "OK" to complete the station setup.

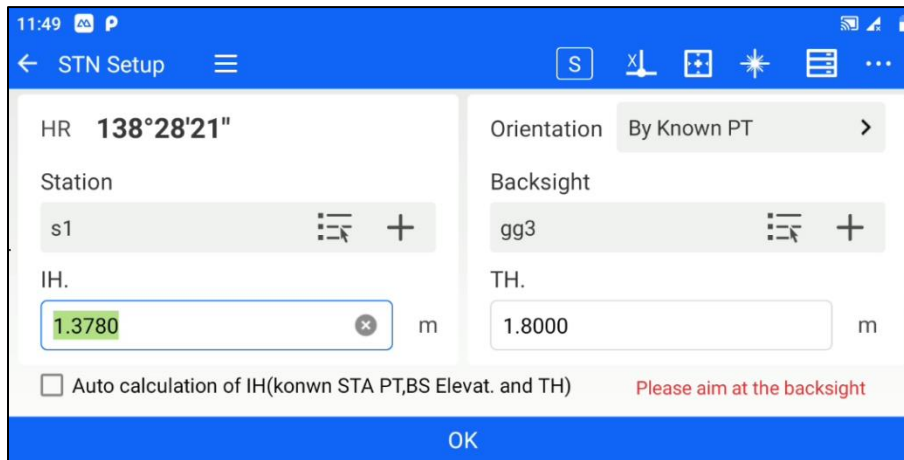

Figure 4-8

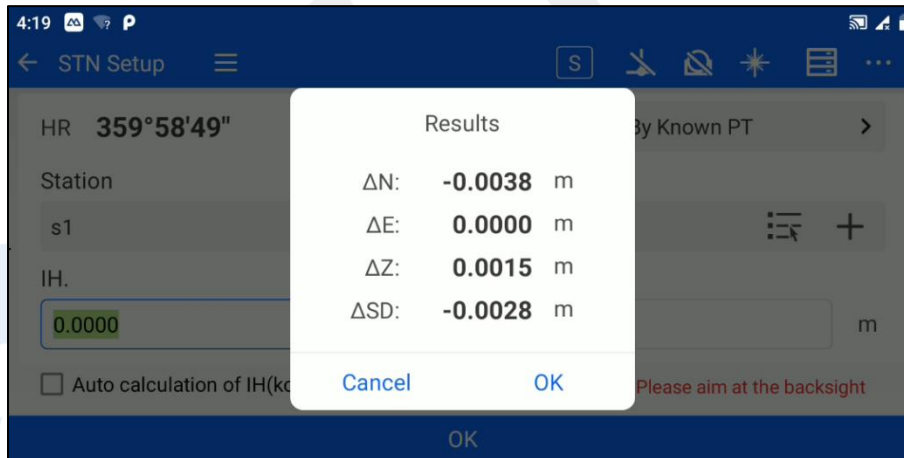

Figure 4-9

4.3.4 Data Acquisition

The software supports various data acquisition programs such as Coordinate Measurement, Offset Measurement, Missing Line Measurement (MLM), Remote Elevation Measurement (REM), Line & Extend Point measurement, and Line & Angle Point measurement. Here is an example of Coordinate Measurement.

1. Click [Measurement] - [Measure] or [Collection] - [Measure] to enter the coordinate measurement interface.

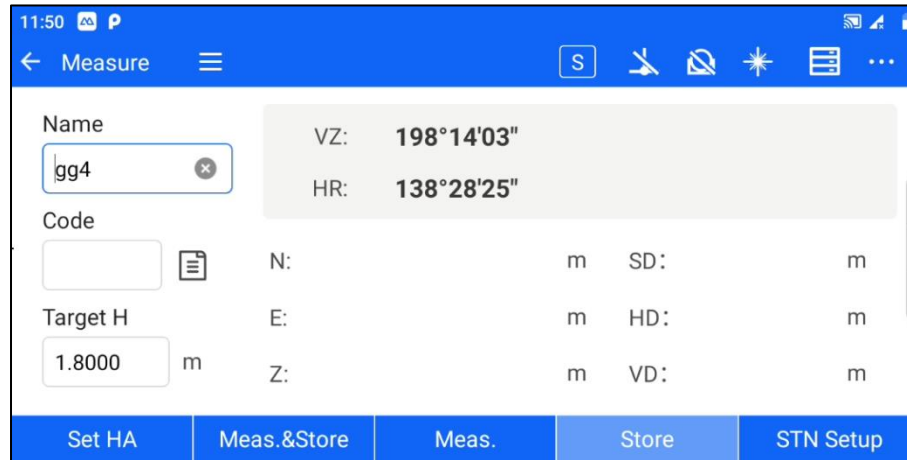

Figure 4-10

2. Aim at the target point, enter the point Name, Code, Target Height, and click [Meas.] - [Store] or directly click [Meas.&Store] to measure.

4.3.5 Data Export

1. Click the top bar icon, and go to [Point Data] - [Meas. Point], you can view the station point, backsight point, prism point, and other kinds of total station points.

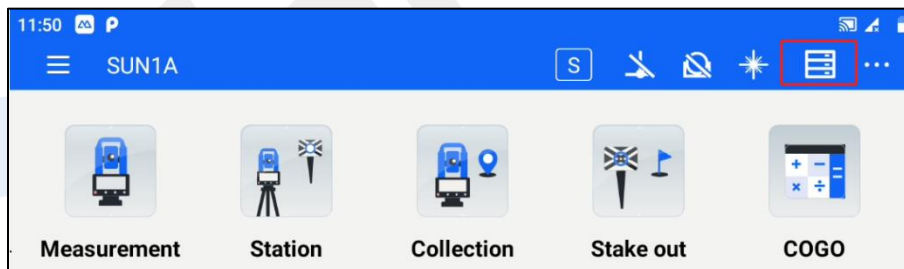

Figure 4-11

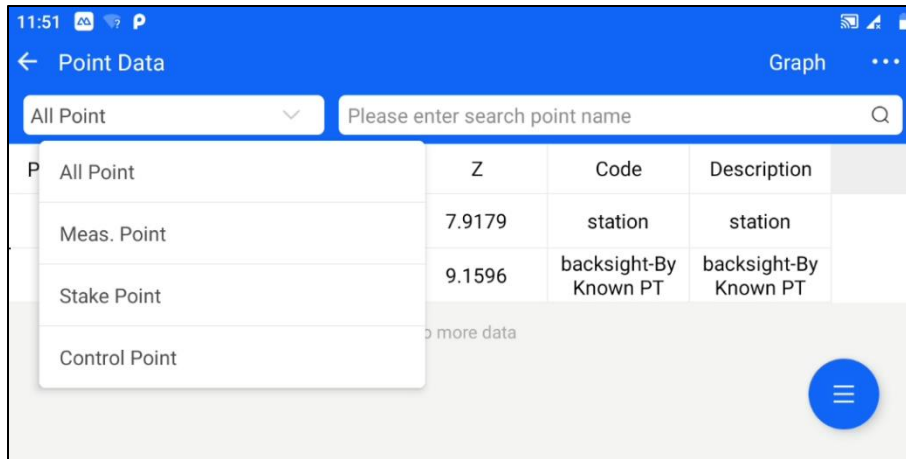

Figure 4-12

2. Click the hover button-[Export] to enter the data export interface.

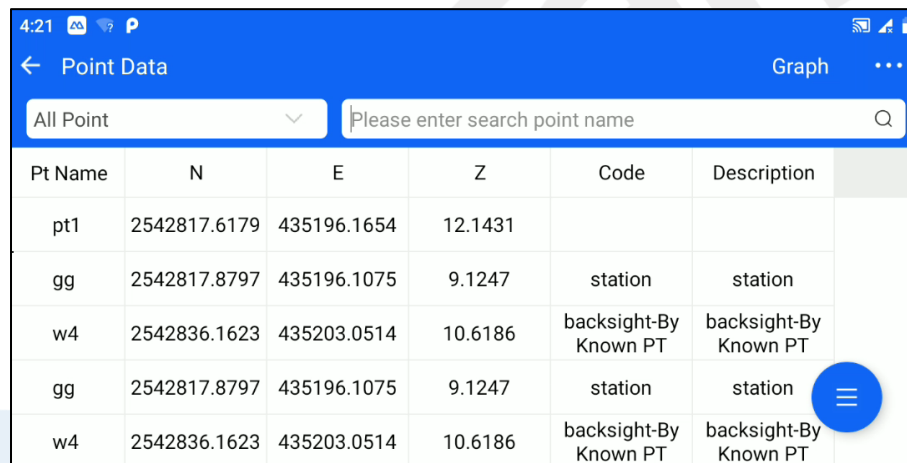

Figure 4-13

3. Select the export format, enter the file name, and click "OK" to export the data to the internal storage of the total station. Export format supports *. htf, *.txt, *.csv, *. dat, *. GSI, *. dxf and *. gt7.

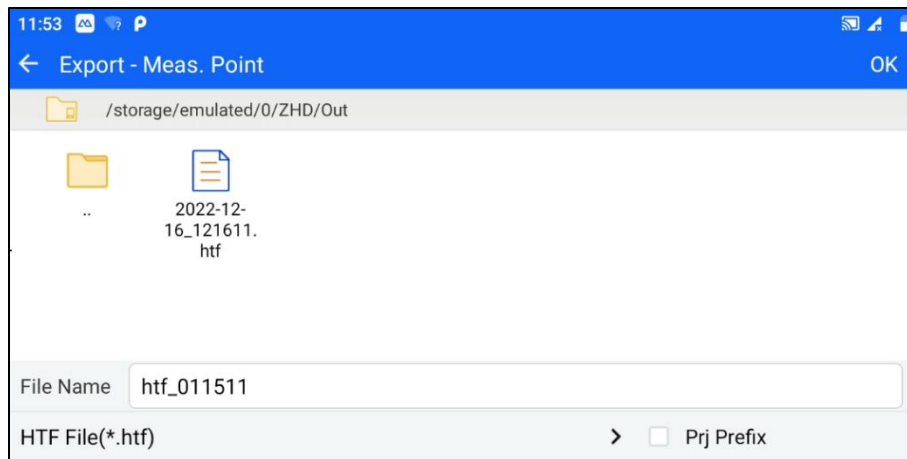

Figure 4-14

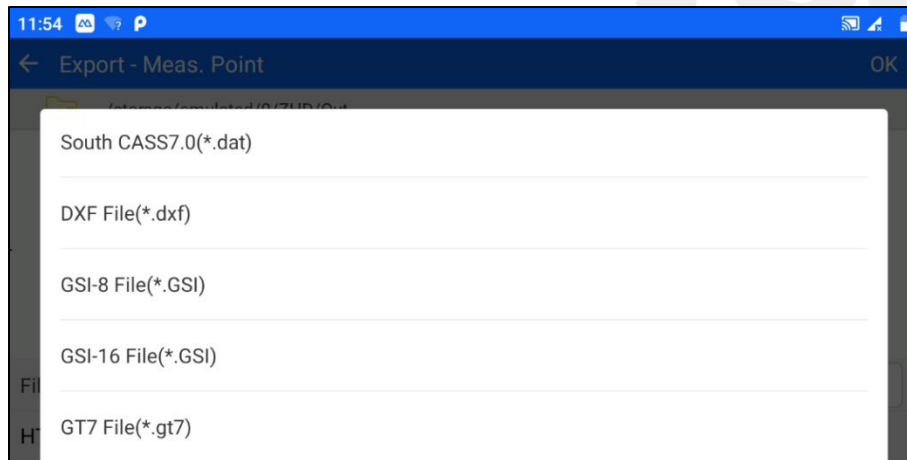

Figure 4-15

Chapter 5

Basic Measurements

This chapter contains:

- Measure
- Point S.O



Hi-Target

5.1 Measure (Coordinate Measurement)

Click [Measurement] - [Measure] or [Collection] - [Measure] to enter the Coordinate Measurement interface.

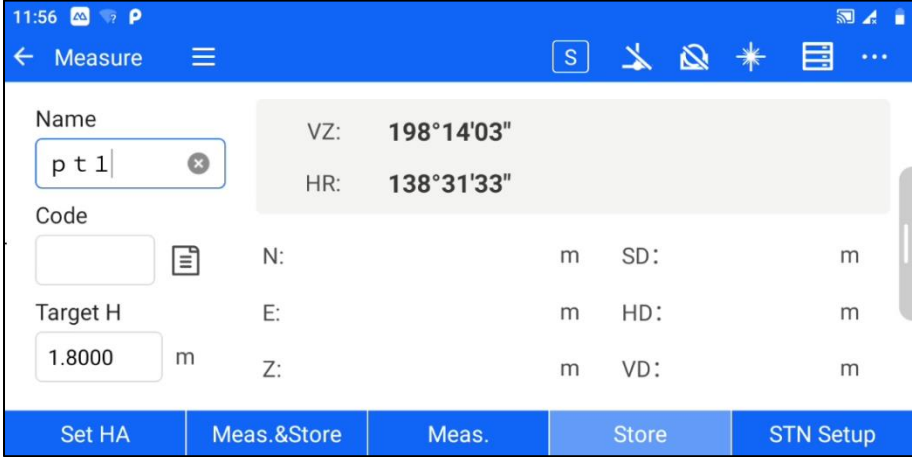

The screenshot shows the 'Measure' interface with the following fields and values:

- Name:** pt 1
- Code:** (empty)
- Target H:** 1.8000 m
- VZ:** 198°14'03"
- HR:** 138°31'33"
- N:** m
- SD:** m
- E:** m
- HD:** m
- Z:** m
- VD:** m

Buttons at the bottom: Set HA, Meas.&Store, Meas., Store, STN Setup.

Figure 5-1

"Name": Measured point name, automatically accumulated by number by default.

"Code": Description of the measured point, which can be entered manually or selected by clicking the button behind the input box.

"Target H": The measured point prism height.

[Set HA]: The horizontal angle can be set to the desired angle.

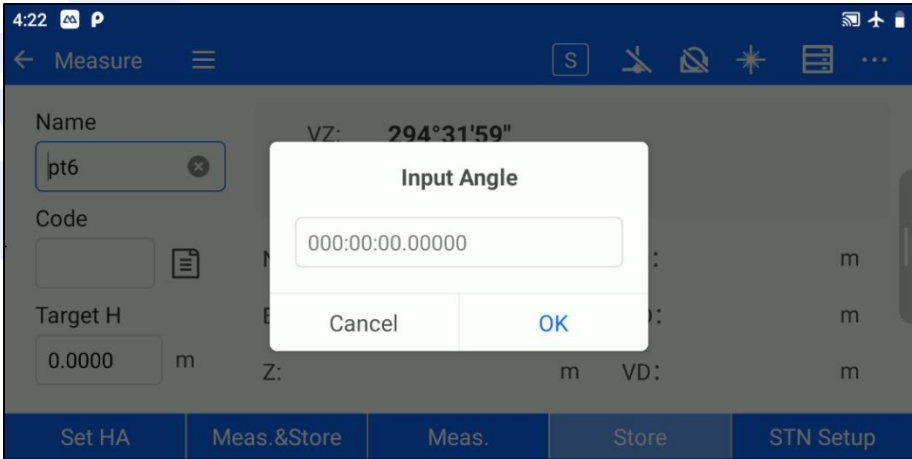

The screenshot shows the 'Measure' interface with an 'Input Angle' dialog box open. The dialog box contains the following information:

- Title:** Input Angle
- Input field:** 000:00:00.00000
- Buttons:** Cancel, OK

The background interface shows the same fields as Figure 5-1, but with the following values:

- Name:** pt6
- VZ:** 294°31'59"
- Target H:** 0.0000 m

Buttons at the bottom: Set HA, Meas.&Store, Meas., Store, STN Setup.

Figure 5-2

When measuring, you can also choose to record the description of the point at the same time. The operation is as follows.

1. Click the [...] icon in the top bar - [Meas. Auxiliary] and turn on the switch of Note.

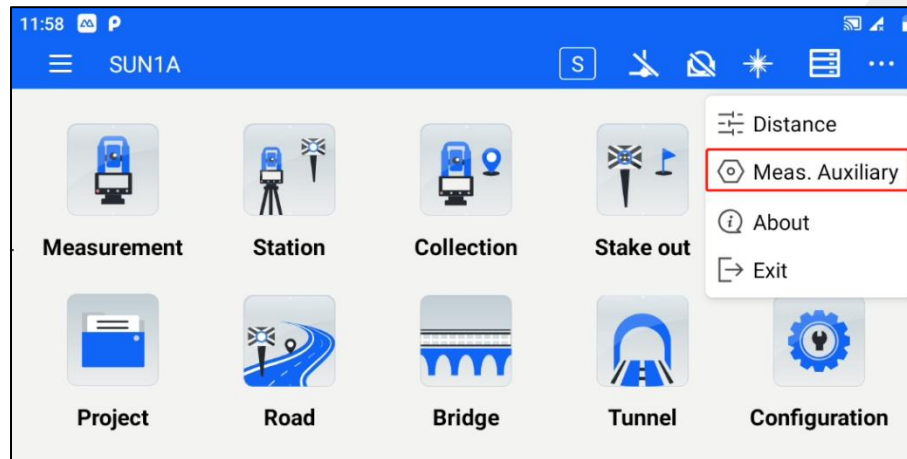

Figure 5-3

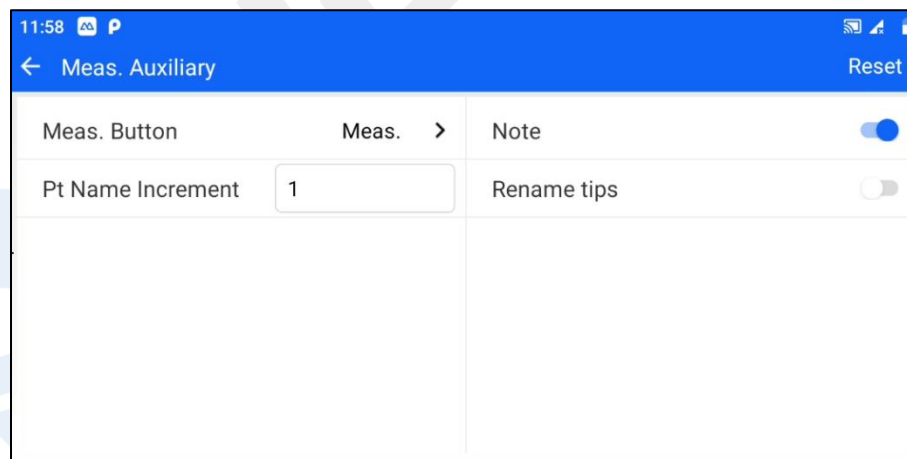

Figure 5-4

2. Return to the [Measure] interface, and the interface will display the image description of the measured point at the same time. When you measure and store the point, the image description of the measured point will be stored at the same time.

Noted: The image function is not available when the USB slot is occupied.

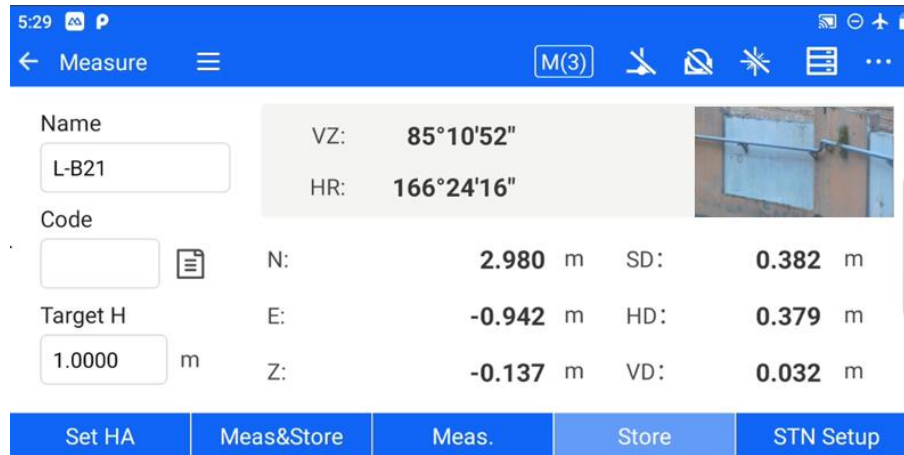

Figure 5-5

The following buttons are common to all collection/stakeout interfaces and will not be repeated after the explanation here.

[Meas.&Store]: Start coordinate measurement and store the data in the measurement point library.

[Meas.]: Start coordinate measurement.

[Store]: When the target point coordinates have been measured, click [Store] to store the target point information in the measurement point library.

[STN Setup]: Jump to the station setup interface.

Click the pull-out icon on the right side of each collection/stakeout interface to expand the graphical interface, which displays the measurement point, stakeout point, and control point distribution map by default. For different acquisition/stakeout program interfaces, corresponding instruction graphics will be displayed.

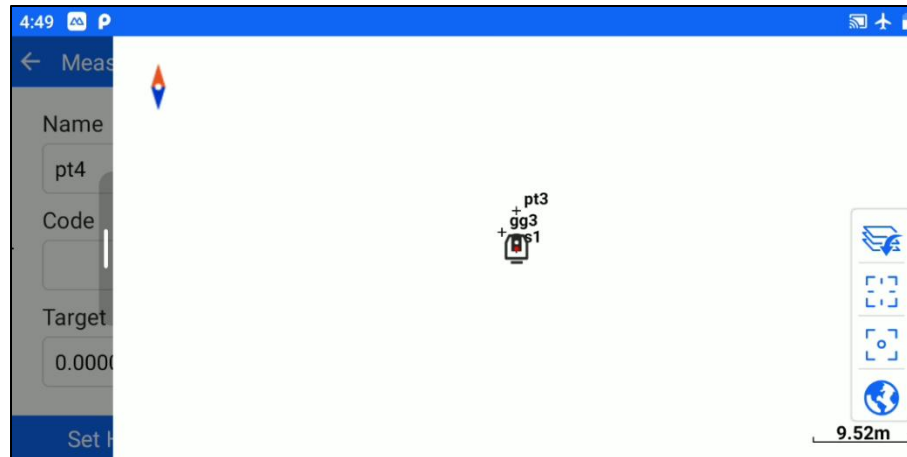

Figure 5-6

5.2 Point S.O (Coordinate Stakeout)

Access through [Measurement] - [Point S.O] or [Stake out] - [Point S.O].

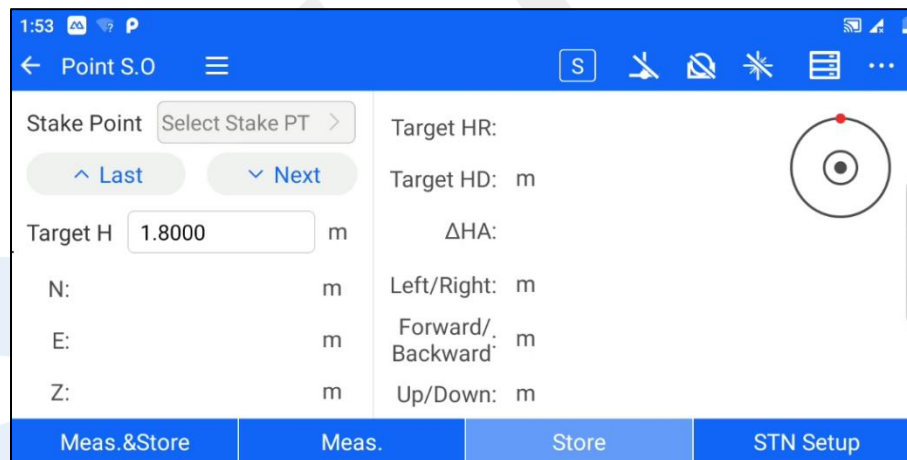

Figure 5-7

[Last] / [Next]: Switch to select the stakeout point in the stakeout point library.

[Select Stake Point]: Enter the stakeout point setting interface.

You can select the stakeout point by manual input, point name search, and list point selection.

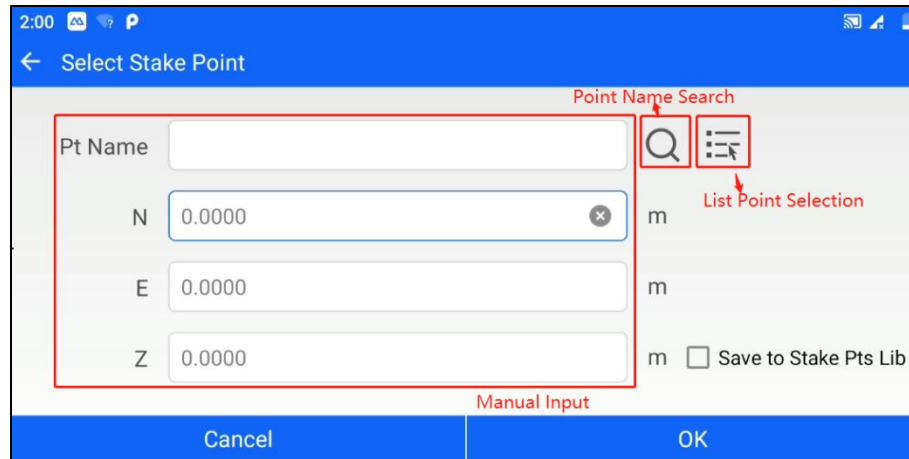

Figure 5-8

"Point Name Search": Perform a precise search based on the entered point name.

"List Point Selection": Jump to the point library and you can select points from each point library.

[Save to Stake Pts Lib]: If checked, the currently set stakeout points will be saved to the stakeout point library.

In the upper right corner of the stakeout interface, the orientation of the stakeout point is shown as a radar map. The red dot is the direction of the stakeout point, and the arrow points to the aiming direction. Users can judge the orientation of the stakeout point by the radar map.

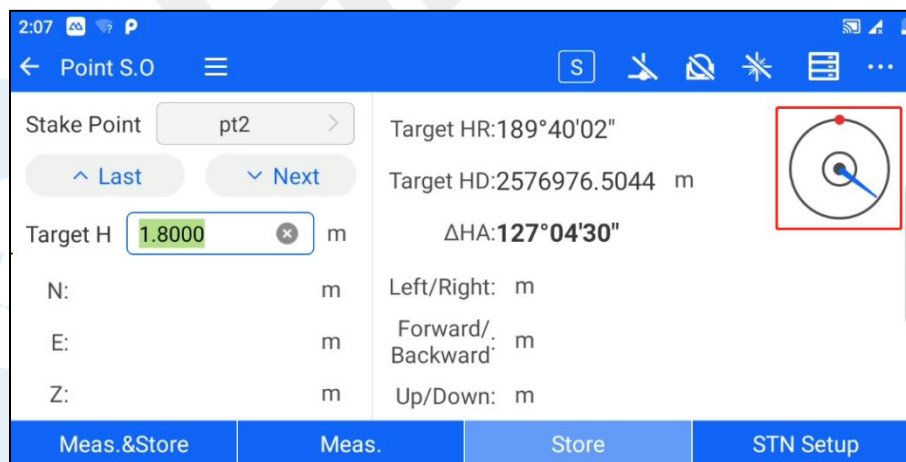

Figure 5-9

Chapter 6

Set up Station

This chapter contains:

- Station Backsight
- Backsight check
- Resection
- Elevation Transfer
- Point to Line Station Set-up



6.1 STN Setup (Orientation with Backsight)

Click [Station] - [STN Setup] or "each measurement interface" - "STN Setup" button to enter the station setup interface.

The station setup with backsight currently supports four orientations: By Known PT, By Azimuth, Without cp, and by free orientation.

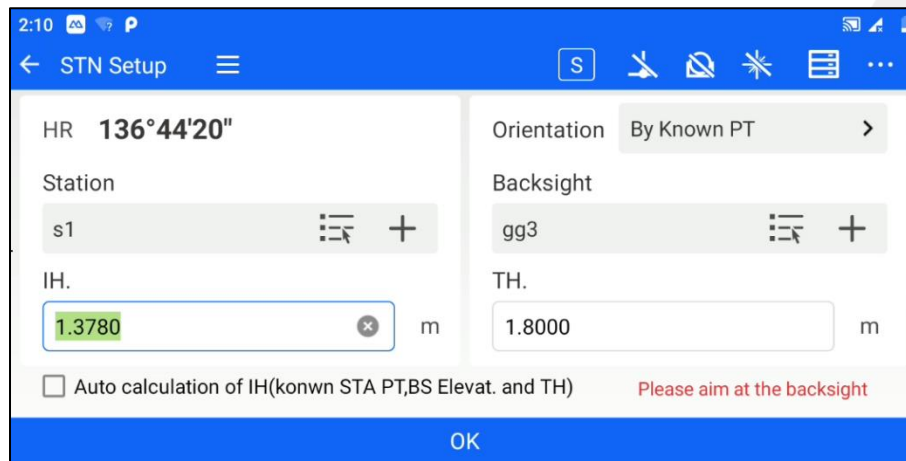

The screenshot shows the 'STN Setup' screen with the following details:

- HR:** 136°44'20"
- Orientation:** By Known PT
- Station:** s1
- Backsight:** gg3
- IH.:** 1.3780 m
- TH.:** 1.8000 m
- Auto calculation of IH(konwn STA PT,BS Elevat. and TH)
- Message:** Please aim at the backsight
- Button:** OK

Figure 6-1

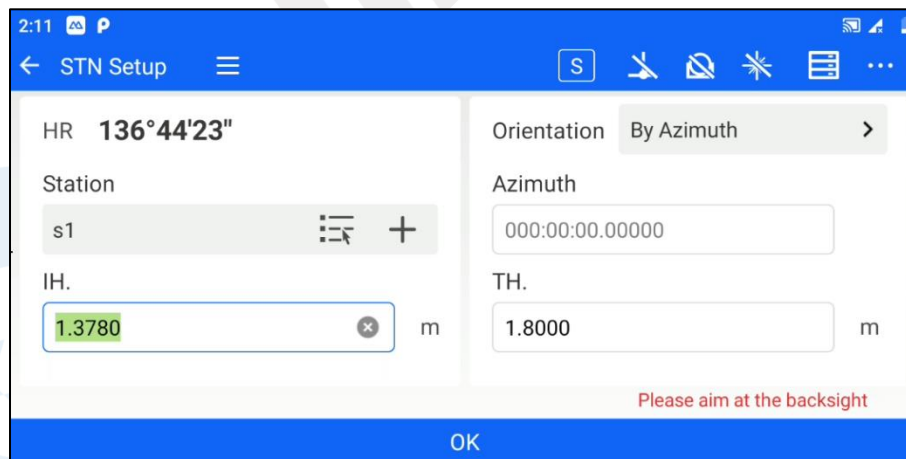

The screenshot shows the 'STN Setup' screen with the following details:

- HR:** 136°44'23"
- Orientation:** By Azimuth
- Station:** s1
- Azimuth:** 000:00:00.00000
- IH.:** 1.3780 m
- TH.:** 1.8000 m
- Message:** Please aim at the backsight
- Button:** OK

Figure 6-2

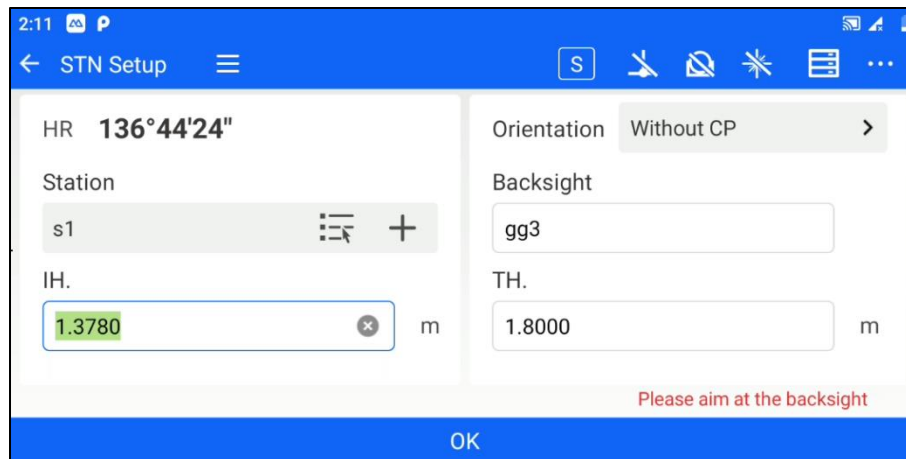

Figure 6-3

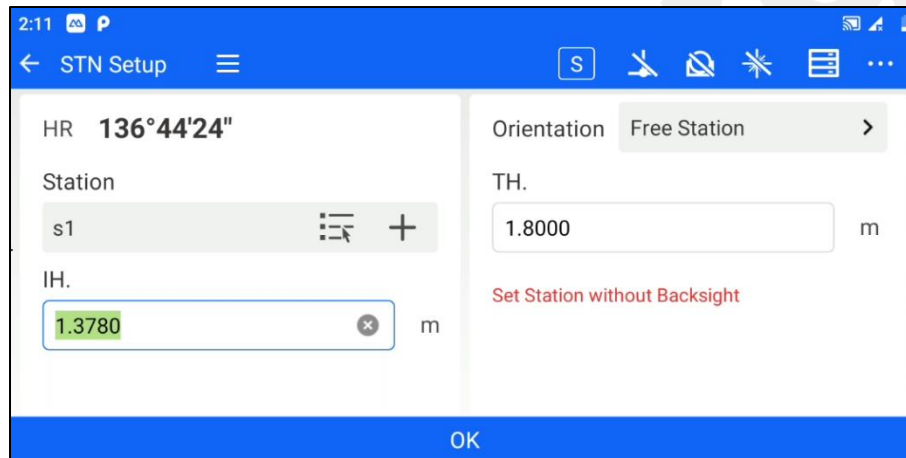

Figure 6-4

6.1.1 By known PT

Coordinate orientation applies to the case where the coordinates of the survey site and the coordinates of the backsight point are known. The operation steps are as follows.

After the user sets up the total station at the survey site, enter the [station backsight] and select the coordinate orientation for the orientation mode.

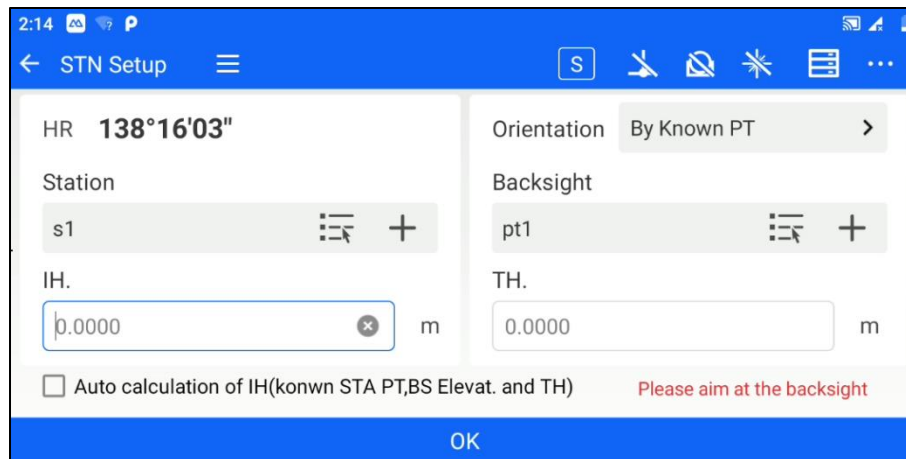

Figure 6-5

1. Set the coordinates of the survey site, the coordinates of the backsight point, the instrument height, and the target height. Coordinates can be set by "list point selection" or "input".
2. Click "OK" to align the Backsight point. At this time, the measurement difference check box will pop up. If the user judges that the difference value is within the acceptable range, click "OK", that is to complete the station hindsight; if the difference value exceeds the limit, click "Cancel", so you can re-direct the coordinates.

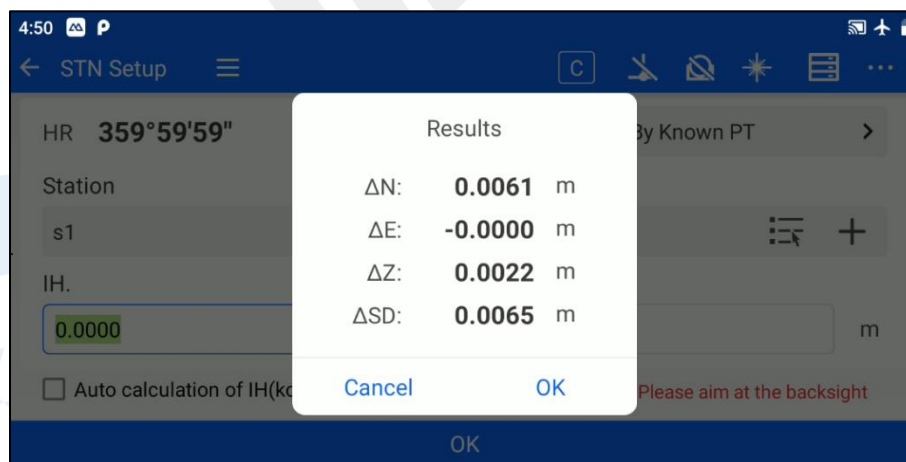

Figure 6-6

"Automatic calculation of instrument height": when the survey site, hindsight elevation, and target height are known, you can check "Automatic calculation of instrument height", the software will automatically calculate the instrument height based on the known information.

6.1.2 Azimuthal Orientation

Azimuth orientation applies to the case where the coordinates and azimuth of the survey site are known. The operation steps are as follows.

1. After the user sets up the total station at the survey site, enter the [station hindsight] and select azimuth orientation for the orientation mode.

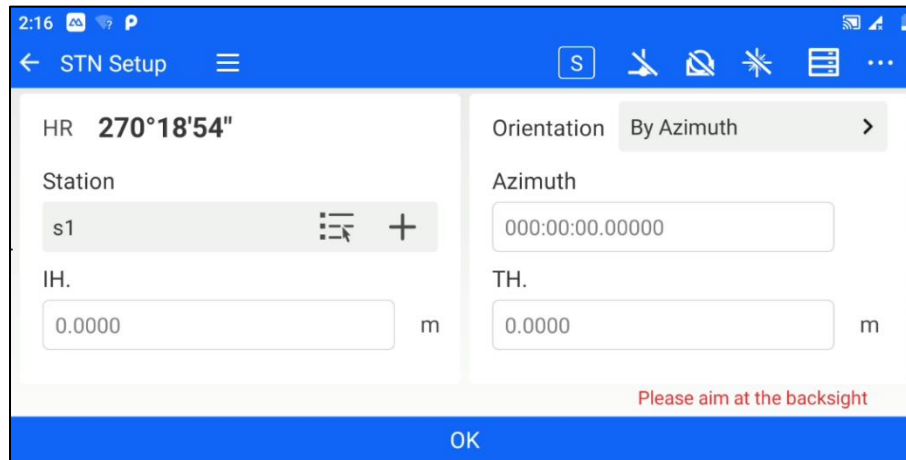

Figure 6-7

2. Set the coordinates of the survey site, the azimuth of the Backsight point, the instrument height, and the target height. Coordinates can be set by "list point selection" or "input".

3. Click on "OK" to complete the station hindsight.

6.1.3 Without CP

Unknown point orientation applies to the case where the coordinates of the survey site are known, and the point location of the backsight point is known but the coordinates are unknown. Usually used in conjunction with [Without CP correction] (see Chapter 9). The operation steps are as follows.

1. After the user sets up the total station at the survey site, enter the [STN Setup] and select the Without CP for the orientation mode.

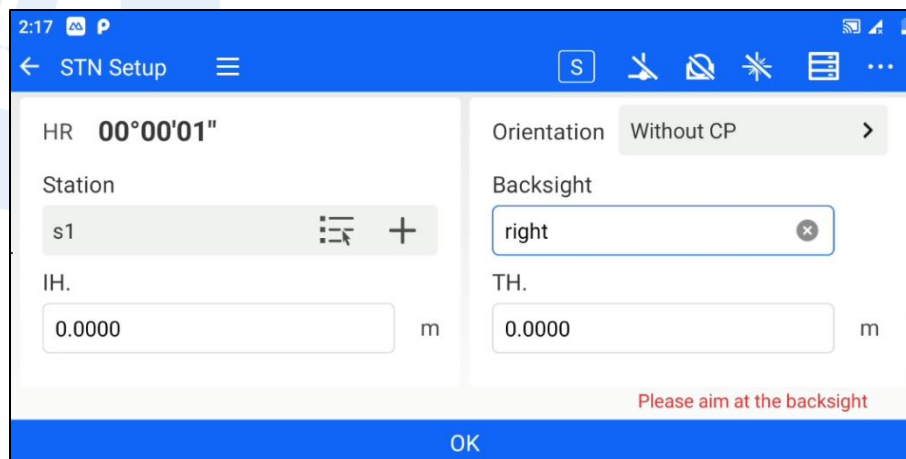

Figure 6-8

2. Set the coordinates of the survey site, the point name of the backsight point, the instrument height, and the target height. Coordinates can be set by "list point selection" or "input".

3. Click on "OK" to complete the station hindsight.

6.1.4 Free Station

Free Station is usually used in conjunction with [Free Station correction] (see Chapter 9). The operation steps are as follows.

After the user sets up the total station at the survey site, enter the [STN Setup] and select the orientation method Free Station.

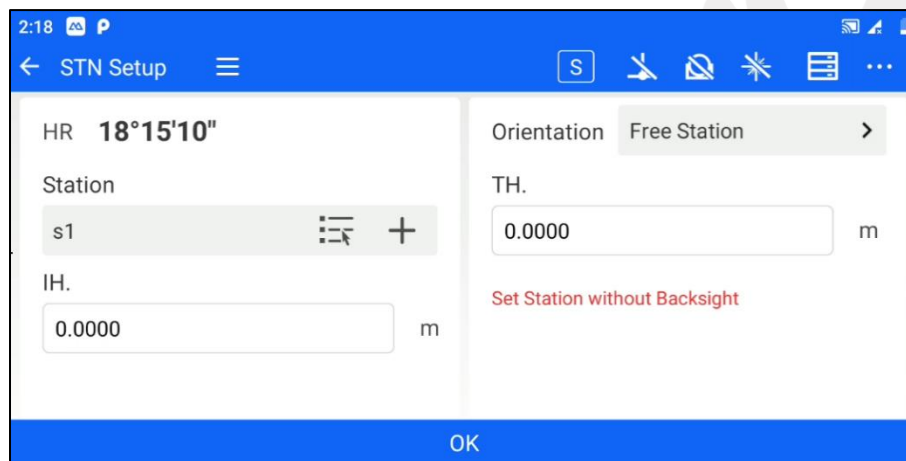

Figure 6-9

2. Set the coordinates of the survey site, instrument height, and target height. Coordinates can be set by "list point selection" or "input".

3. Click on "OK" to complete the station hindsight.

6.2 BS Check

After the user set the station, if you want to check whether the current Backsight direction horizontal angle and the recorded Backsight point direction horizontal angle are consistent, you can use the Backsight check function, which can be accessed through [STN Setup] - [BS Check].

If the current station setting method is "By Known PT", the "Meas." and "Reset" buttons are displayed on the Backsight inspection screen.

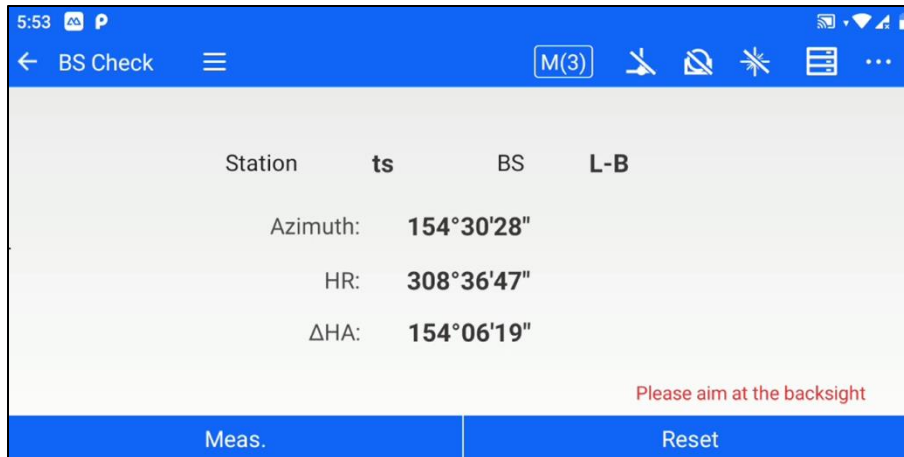

Figure 6-10

[Meas.]: Click measurement when aiming at the Backsight point, and get the coordinate difference between the measurement coordinates and the Backsight point, and the distance difference to the measuring station.

[Reset]: Reset the horizontal angle to the Backsight point azimuth.

If the current station setting method is "Azimuth Orientation"/"Without CP"/"Free Station", the Backsight check screen will only display the "Reset " button.

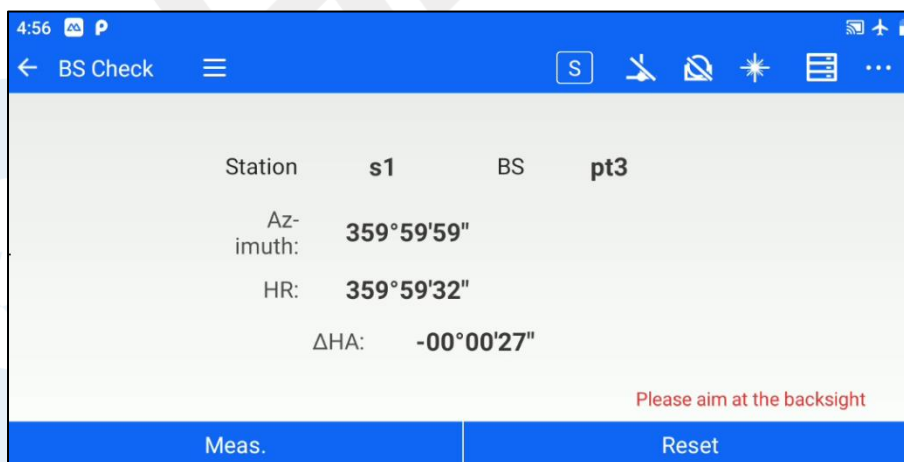

Figure 6-11

6.3 Resection

When the coordinates of the survey site are unknown, but there are 2~5 known points within the visual range, you can use the Resection function to obtain the coordinates of the survey site through the edge rendezvous calculation. Through [STN Setup] - [Resection] enter the Resection interface. The operation

steps are as follows.

1. Click [Resection] to enter the measurement interface.

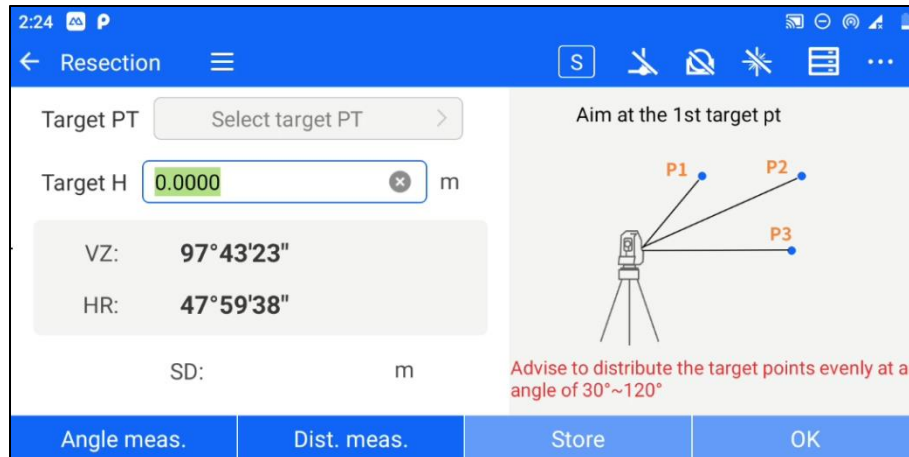

Figure 6-12

2. Click "Select target PT", the target point is known. Users can set it by "manual input", "list point selection" or "search point library".

[OK]: After setting the coordinates of the target point, click "OK" to finish the setting and return to the measurement interface.

[Cancel]: Cancel to set the target point coordinates and return to the measurement interface.

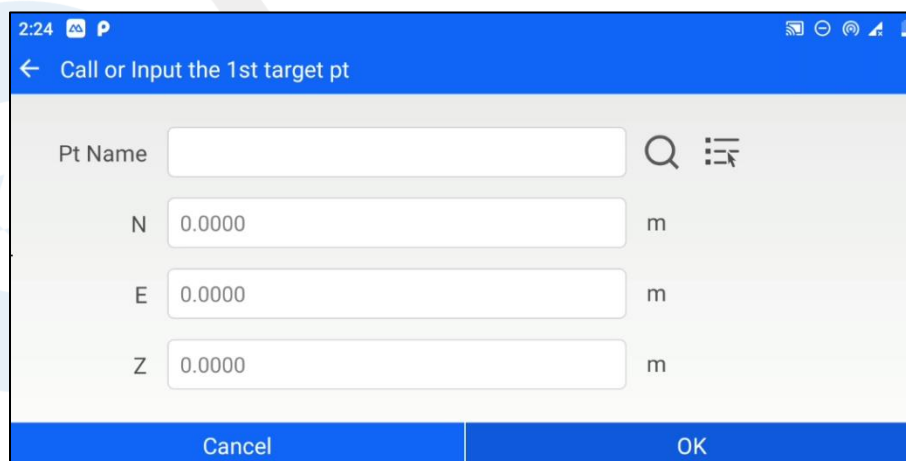

Figure 6-13

3. After completing the selection of the target point, aim at the target point and measure (distance) or angle.

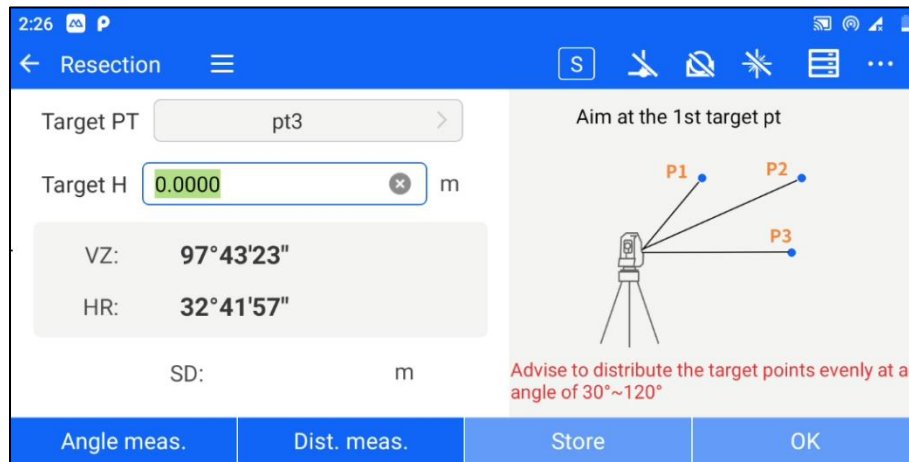

Figure 6-14

[Angle meas.]: Click on the angle meas. when aiming at the target point, and get the angle data from the measurement station to the target point.

[Dist.meas.]: Click dist.meas. when aiming at the target point to get the slant distance from the measuring station to the target point.

[Store]: After measuring the target point, click "store" to return to the point list and store the distance point/angle point in the measurement point library.

[OK]: After you have measured the target points, click "OK" to return to the point list.



Note: 1. Distance measurement requires at least 2 points, and an angle of 30°~120° for every two points is preferred.
2. At least 3 points are required for angle measurement, and the point to be determined needs to be inside the triangle formed by the 3 observation points.

4. The Resection point list interface shows all the points that have been measured currently. At the bottom, you can set "IH". Click on the corresponding data to "delete" the operation.

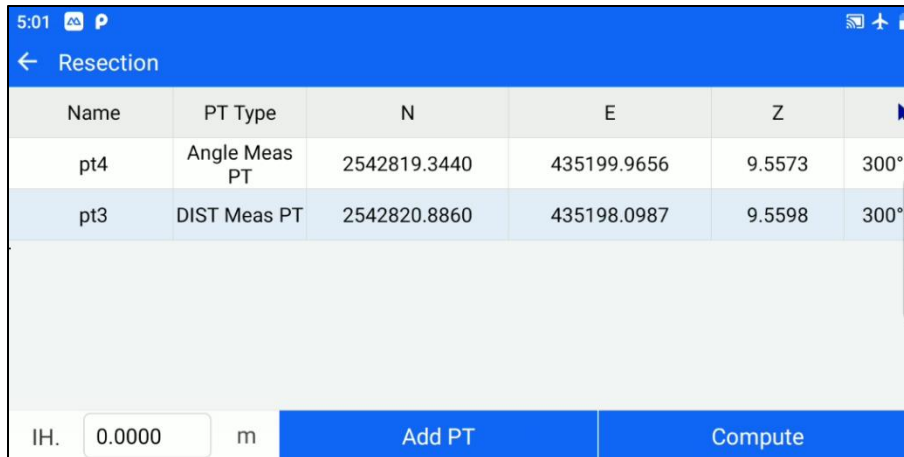

Name	PT Type	N	E	Z	MA
pt4	Angle Meas PT	2542819.3440	435199.9656	9.5573	300°3
pt3	DIST Meas PT	2542820.8860	435198.0987	9.5598	300°3

IH. m Add PT Compute

Figure 6-15

[Add PT]: You can continue to add known points for measurement and repeat steps 2~3.

[Compute]: Based on the current existing measurement points and the set instrument height, calculate the coordinates of the measurement site.

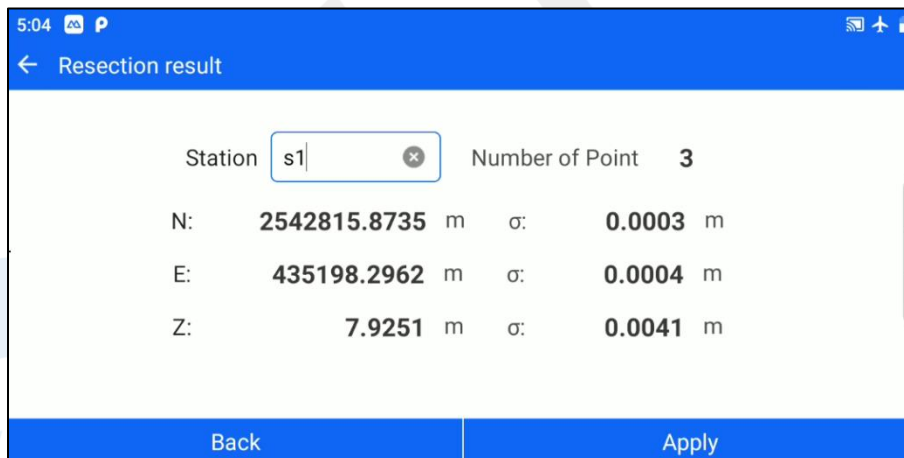

Station Number of Point **3**

N:	2542815.8735 m	σ :	0.0003 m
E:	435198.2962 m	σ :	0.0004 m
Z:	7.9251 m	σ :	0.0041 m

Back Apply

Figure 6-16

[Back]: Return to the resection point list interface, you can continue to add points to calculate.

[Apply]: Apply the calculated Resection results to the current measurement site, the calculated measurement site, and the last known point for the Backsight point to complete the set-up, the new measurement site, and the Resection Backsight point in the point database.

6.4 Elevation Transfer

When the elevation of the survey site is unknown, but there are known elevation points within the visual range, you can use the elevation transfer function to calculate and obtain the coordinates of the survey

site after the station is set up in the station's hindsight. You can enter the elevation transfer interface through [STN Setup] - [Elevation Transfer]. The operation steps are as follows.

1. After the user sets up the station, click [Elevation Transfer] to enter the measurement interface.

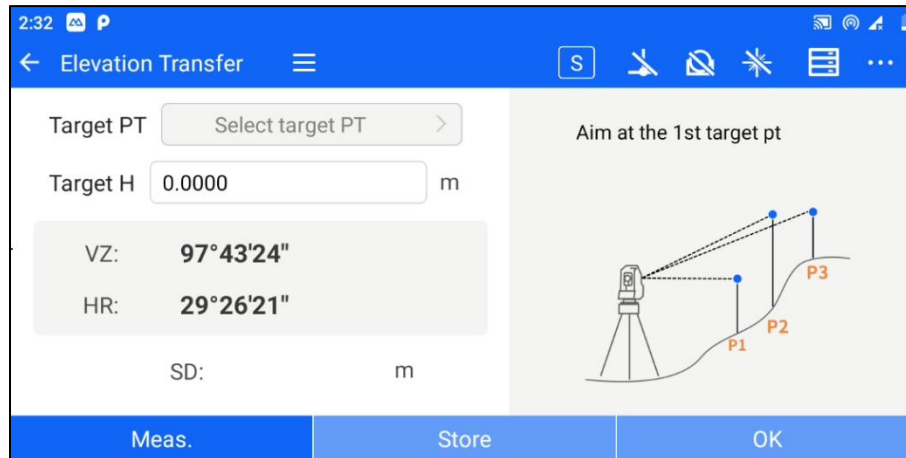

Figure 6-17

2. Click "Select target point", the target point is the known point of elevation. The user can set it by "manually input elevation", "list selection" or "search point library".

[OK]: After setting the elevation of the target point, click "OK" to finish the setting and return to the measurement interface.

[Cancel]: Cancel to set the elevation of the target point and return to the measurement interface.

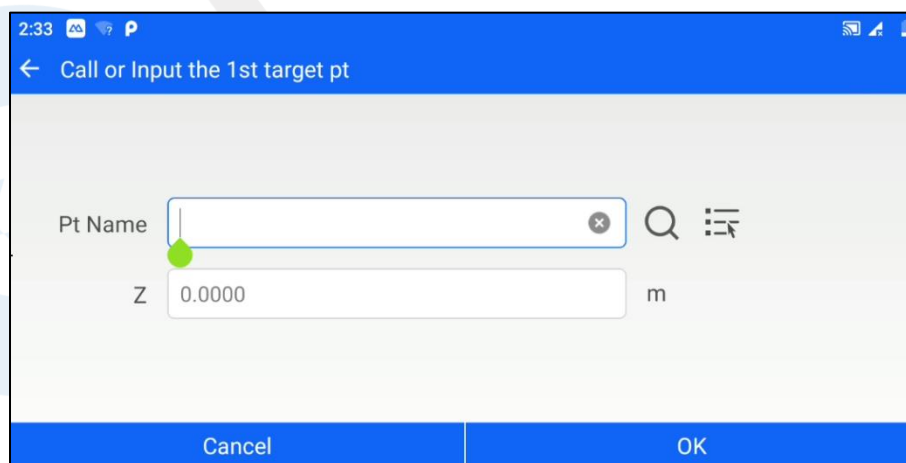

Figure 6-18

3. After completing the selection of the target point, aim at the target point and make the measurement.

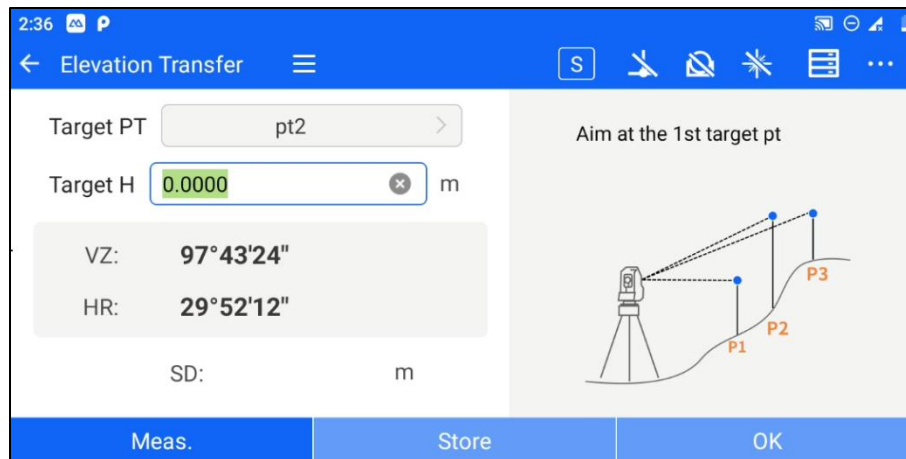

Figure 6-19

[Meas.]: Click measure when aiming at the target point to get the slant distance from the measuring station to the target point.

[Store]: After you have measured the target point, click " store " to return to the point list and store the distance measurement point in the measurement point library.

[OK]: After you have measured the target points, click "OK" to return to the point list.

4. The elevation transfer point list interface shows all the points that have been measured currently. At the bottom, you can set the "IH". Click on the corresponding data to "delete" the operation.

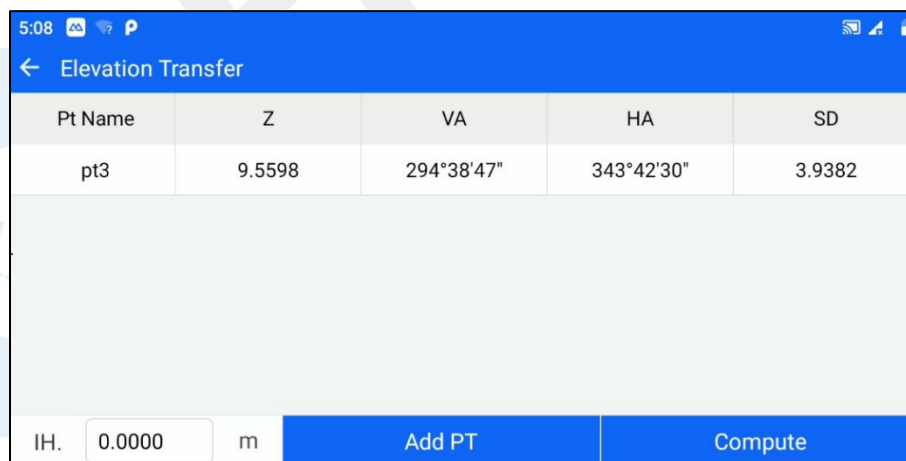

Figure 6-20

[Add PT]: You can continue to add known points for measurement, repeat steps 2~3. A minimum of 1 known point is required for elevation transfer.

[Compute]: Based on the current existing measurement points and the set instrument height, calculate

the elevation of the measurement site.

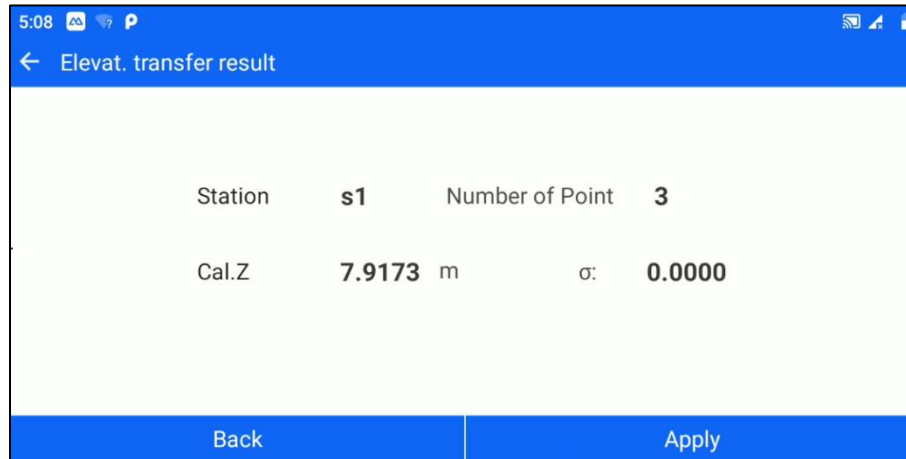

Figure 6-21

[Back]: Return to the elevation transfer point list interface, you can continue to add points to calculate.

[Apply]: Apply the calculated elevation to the current measurement site, and the Z coordinate of the measurement site in the point database is changed correspondingly.

6.5 Point to Line

For projects that only need the local relative coordinate system, users can use the function of "Point to Line Setting" to establish a local relative coordinate system based on a certain line. You can enter the point-to-line setting interface through [STN Setup] - [Point to Line]. The operation steps are as follows.

1. Click [Point to the line] to enter the measurement interface of the straight line - starting point A. Enter the target height according to the instruction, click "Meas." for the starting point of the reference line, and then click "Next".

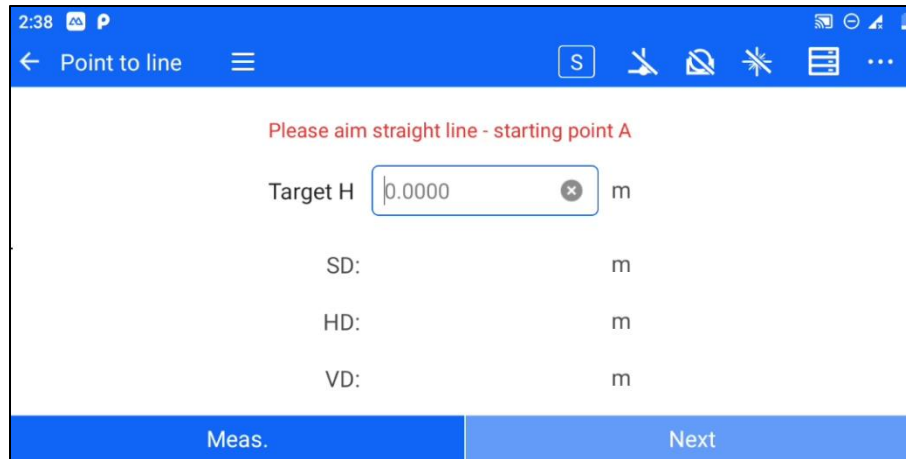

Figure 6-22

2. Enter the measurement interface of straight line - end point B. Enter the target height according to the instruction, click "Meas." for the end point of the reference line, and then click "Next".

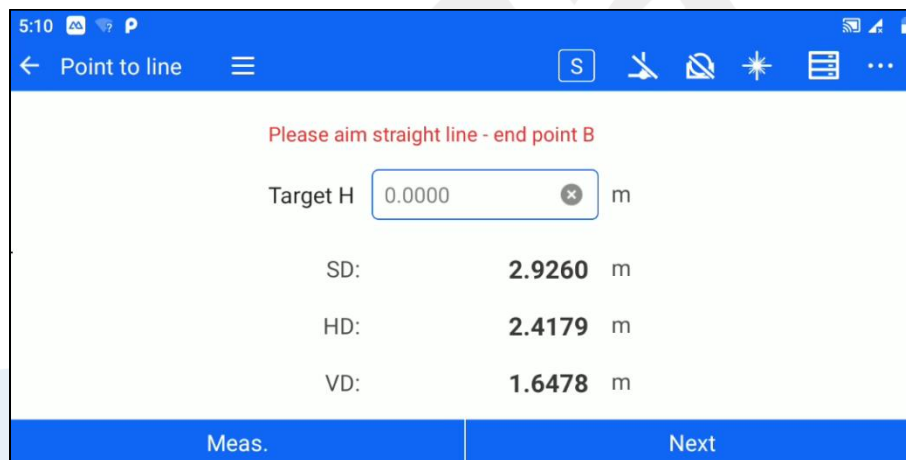











Figure 6-23

3. Enter the point-to-line set station interface. Continue to align the end point of the reference line (as the Backsight point), enter the point name, Ground code, and instrument height of the station, and click "OK" to complete the point-to-line station setting. The local relative coordinate system of the reference line established by the station is with point A as the coordinate origin (0,0,0), point B as the coordinate north direction, and the coordinates of point B relative to point A are (Hd, 0, Vd).

5:11  

← Point to line       

Station Please enter IH. and keep sighting the straight line - end point B

ts

Code 

Station	Straight line A-B	
N:	3.3455 m	Δ SD: 1.6901 m
E:	-1.0406 m	Δ HD: 1.1630 m
Z:	-0.4214 m	Δ VD: 1.2264 m

IH. m

OK

Figure 6-24

Chapter 7

Collection Program

This chapter contains:

- Measure
- Dist. Offset
- Plane Offset
- Column Offset
- MLM
- REM
- Line & Extension Point
- Line & Angle

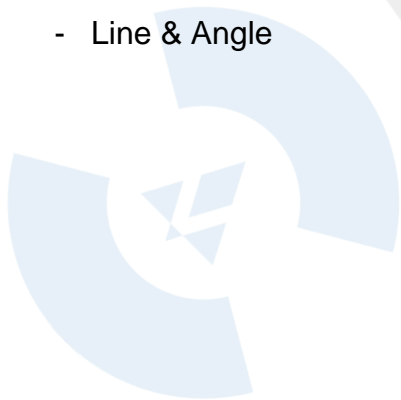

7.1 Measure (Coordinate Measurement)

See Chapter 5 Basic Measurement - Coordinate Measurement.

7.2 Dist. Offset

If the point to be measured (P) is known to deviate from the Offset point (T0) in the observation direction of the front and rear, left and right Offset, then the coordinates of the T0 point can be measured by the Distance Offset function. You can enter the Distance Offset interface through [Collection] - [Dist. Offset]. The operation steps are as follows.

1. Enter the Offset distance as shown in the figure below and click "OK".

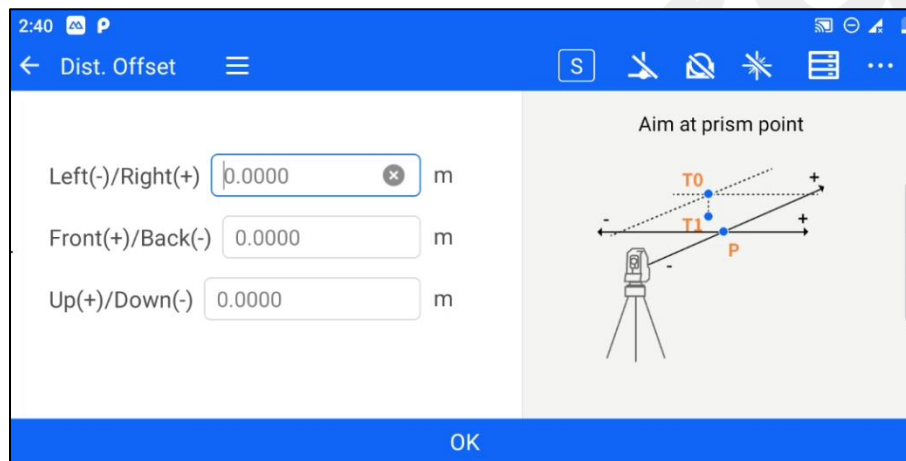

Figure 7-1

2. Aim at the target point and click "Measure" to get the distance between the station and the target point.

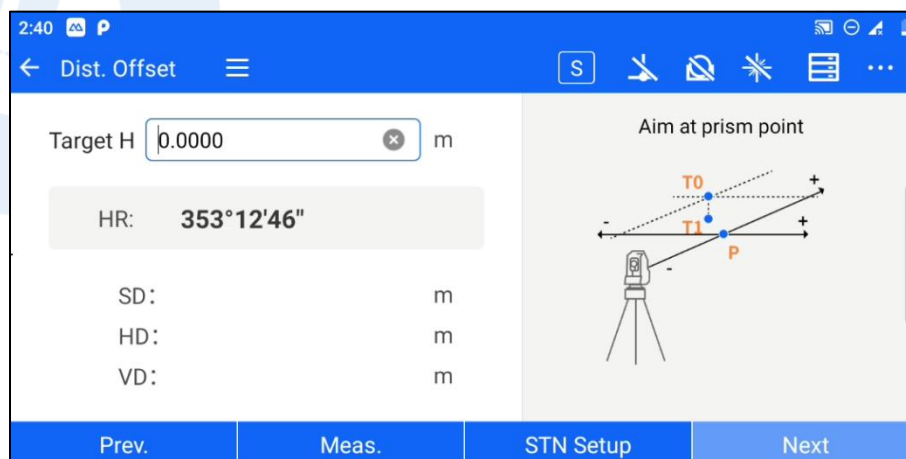

Figure 7-2

3. Click "Next" to display the distance and coordinates of point T0.

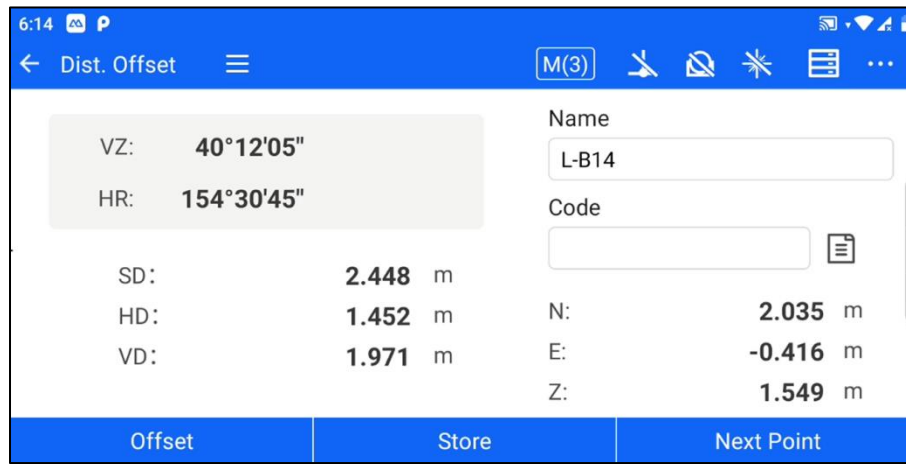

Figure 7-3

[Store]: store the Offset points obtained by calculation to the point library.

[Next point]: You can recalculate the next point from step 1.

7.3 Plane Offset

This function is used to determine points that cannot be measured directly, such as determining the distance or coordinates of a plane edge. The plane Offset interface can be accessed through [Collection] - [Plane Offset]. The operation steps are as follows.

1. Aim at the first point P1 on the plane and click "Meas." to get the distance measurement data. Click "Next".

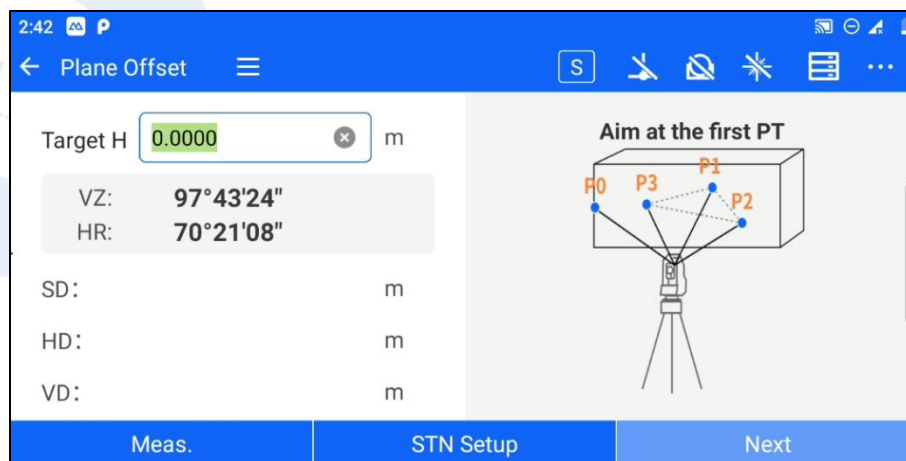

Figure 7-4

2. Repeat step 1 and measure the second point P2 and the third point P3 on the plane to determine the plane being measured.

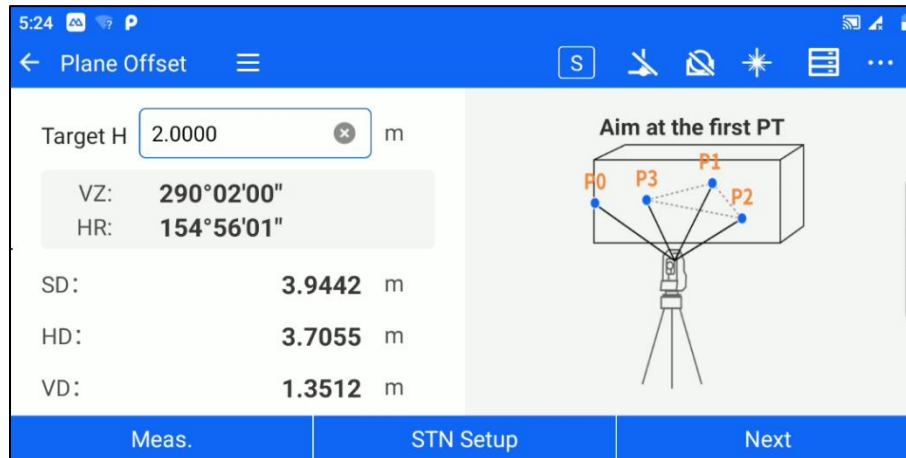

Figure 7-5

3. Aim at Measured point P0, Then the instrument calculates and displays the coordinates of the point of intersection of the alignment axis and the plane - the coordinates of point P0.

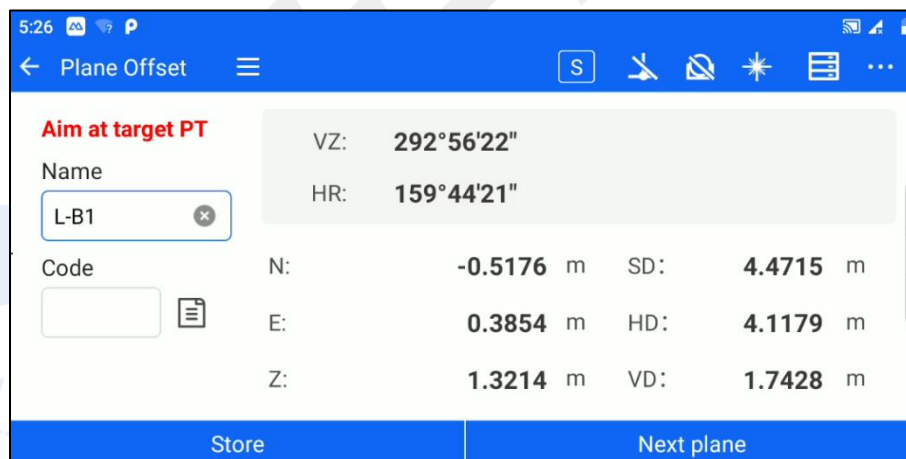

Figure 7-6

[Store]: Store the Offset points obtained by calculation to the point library.

[Next plane]: You can recalculate the next point from step 1.

7.4 Column Offset

This function is used to determine the circular center point position of cylindrical objects, such as the determination of large trees, oil tanks, etc. The Cylindrical Offset interface can be accessed through

[Collection] - [Column Offset]. The operation steps are as follows.

1. Aim at the first point P1 on the edge of the cylinder, click "Next", and get the horizontal angle data while going to the next step.

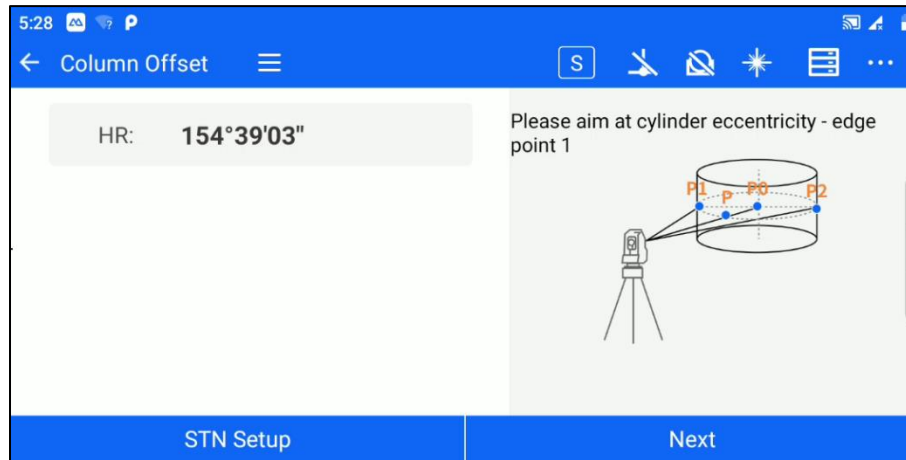

Figure 7-7

2. Aim at the second point P2 on the edge of the cylinder and click "Next" to get the horizontal angle data while going to the next step.

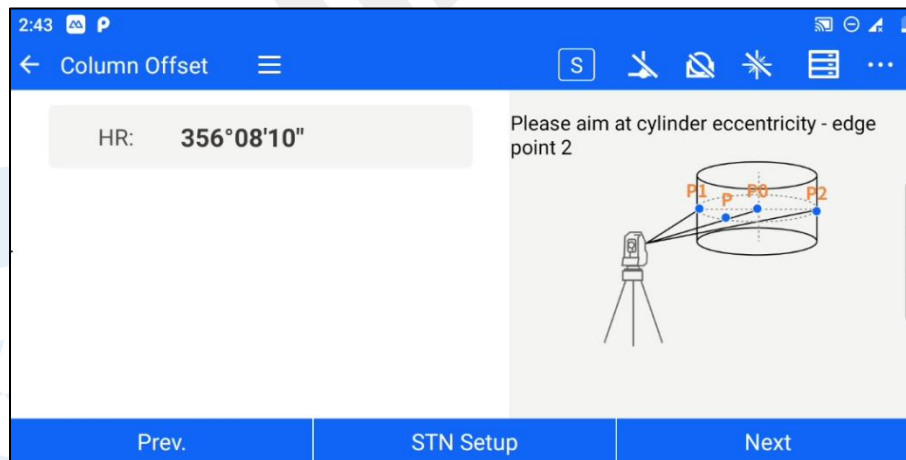

Figure 7-8

3. Aim at point P on the cylindrical surface and click "Meas." to get the azimuth and distance data. Note that if you want to measure the coordinates of point P0, enter 0 for the target height; if you want to measure the coordinates of the ground point corresponding to P0, enter the height of P from the ground for the target height.

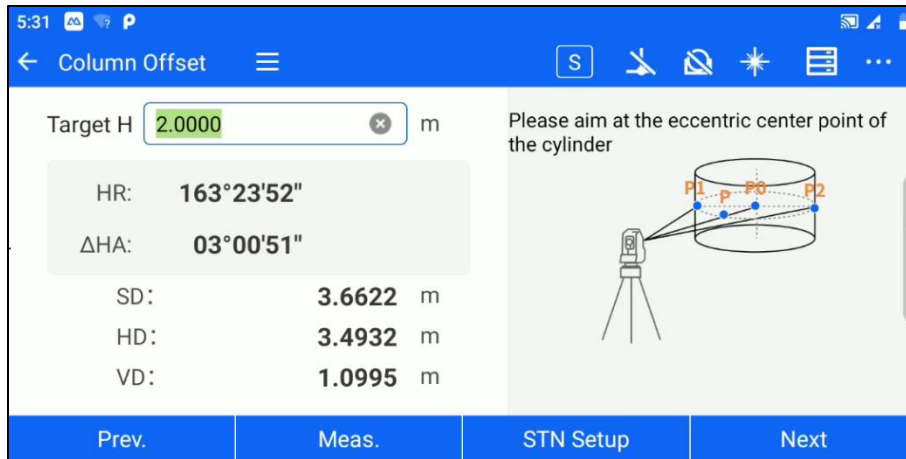

Figure 7-9

4. Click "Next" to derive the coordinates of the center of the cylinder, you can choose [Store], [next point].

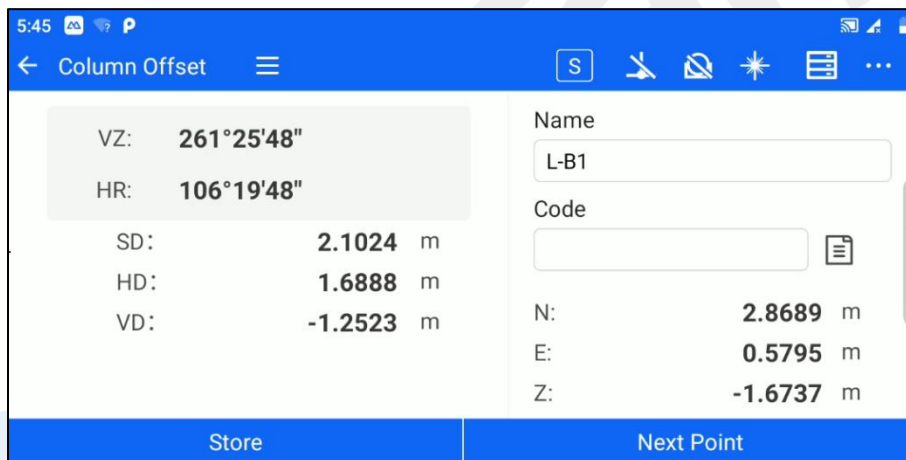

Figure 7-10

7.5 MLM

MLM is used to calculate the SD(slope distance), HD(horizontal distance), and VD(vertical distance) of two target points, after measuring a series of points, you can connect the target points by "ray" or "line" to calculate the SD, HD, and VD between the two points.

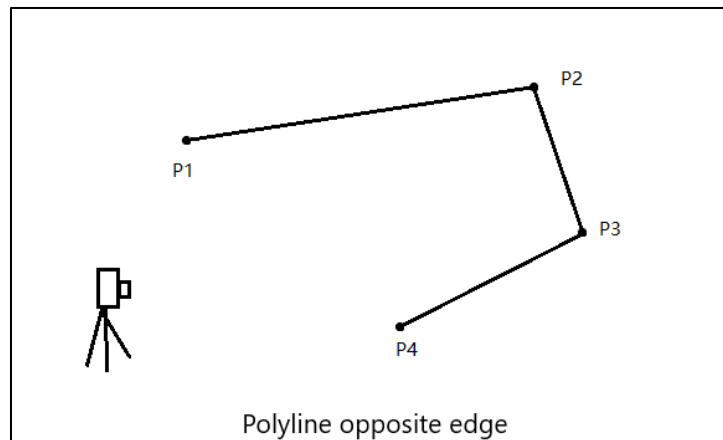

Figure 7-11

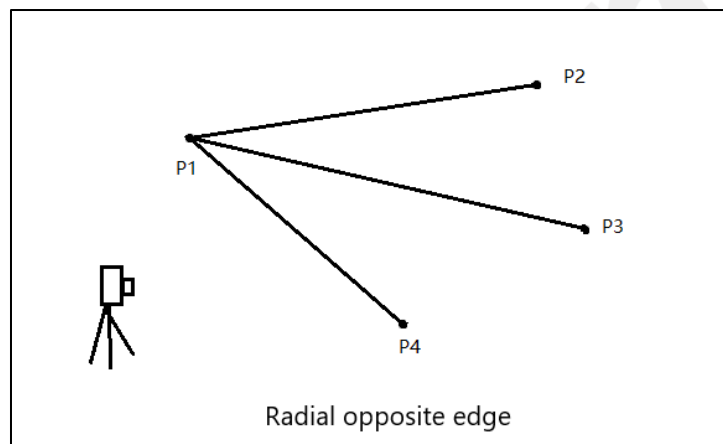

Figure 7-12

You can enter the interface of MLM through [Collection] - [MLM]. The operation steps are as follows.

1. After the user sets up the station, click [MLM] to enter the measurement interface. After measuring the first point P1, click [OK].

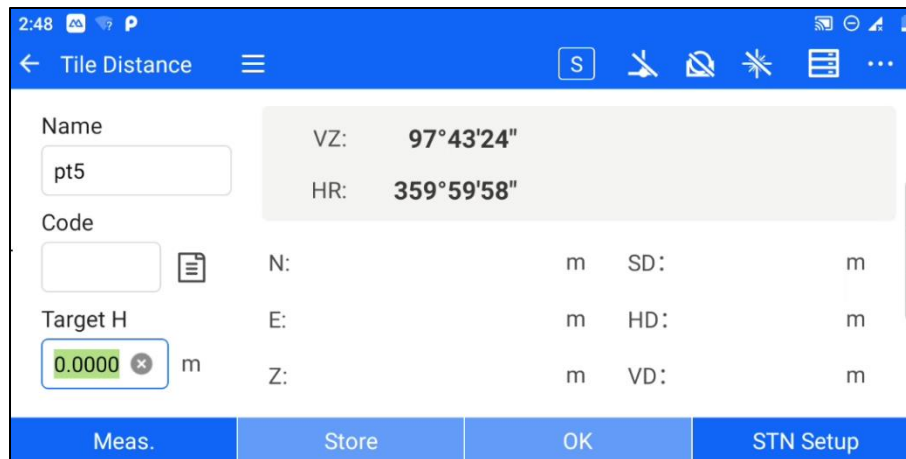

Figure 7-13

2. Enter the [MLM] data page to display the measurement point data information.

[Meas.]: Enter the measurement interface, you can add points for measurement operation.

[Clear]: Clear all the point information on the current data page.



Figure 7-14

3. After measuring 2 or more points, you can switch to the [Result] page to view the MLM results. The radio box at the bottom of the data page can choose the calculation method of "ray to MLM" or "polyline to MLM".



Name	ΔSD	ΔHD	ΔVD	Azimuth
L-B1-L-B2	0.3689	0.0039	0.3689	156°59'37"
L-B1-L-B3	0.6972	0.5878	0.3749	270°16'31"
L-B1-L-B4	0.3950	0.3545	0.1743	269°26'22"

Figure 7-15

7.6 REM

Remote Elevation Measurement is used to directly measure the elevation difference from the overhang point to the base point where the prism cannot be placed above the base point, divided into ground overhang height and reference point overhang height. You can enter the Remote Elevation Measurement interface through [Collection] - [REM].

7.6.1 Ground REM

The ground REM is used to calculate the distance from the target point to the ground, and the target height needs to be filled in. The operation steps are as follows.

1. The user enters [MLM] and selects "Ground REM". Aim at the target point P, set the target height, and click [Meas.] to get the angle and distance information. Then click [Next].

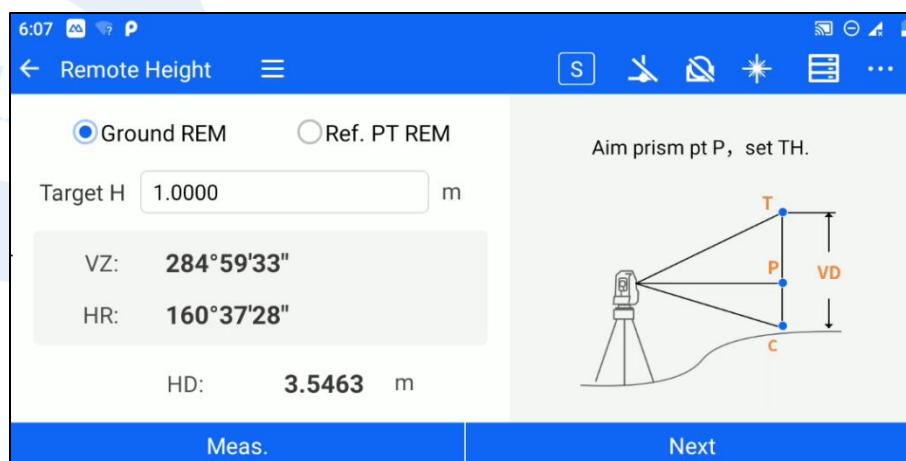

Figure 7-16

2. Aim at the target point T, Get the value of REM in real-time.

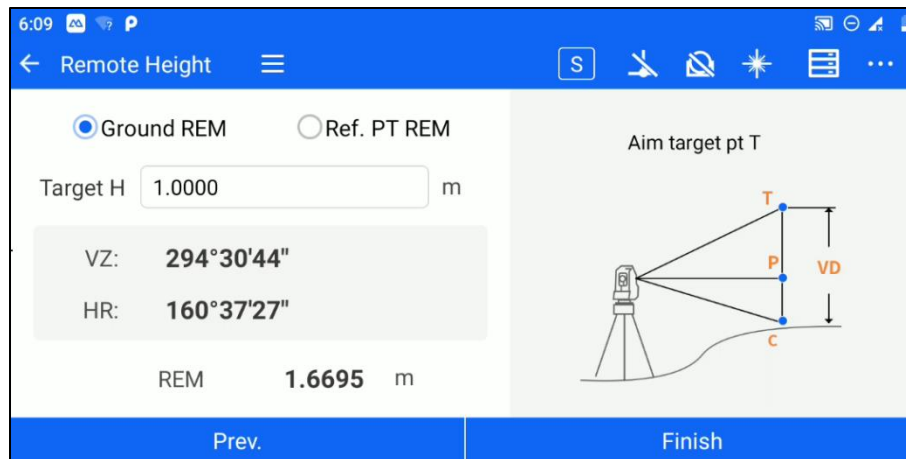

Figure 7-17

[Prev.]: Return to the previous step, you can view the previous measurement information.

[Finish]: Restart the REM.

7.6.2 Reference Point REM

The ground overhang height is used to calculate the distance from the target point to the reference point without filling in the target height. The operation steps are as follows.

1. The user enters [MLM] and selects "Ref. PT REM". Aim at the prism P and click [Meas.] to get the angle and distance information. Then click [Next].

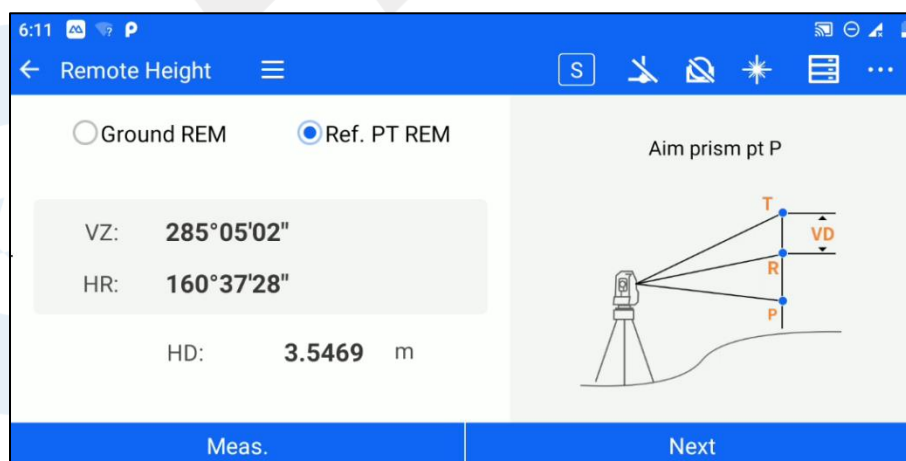

Figure 7-18

2. Aim at the reference point R, the software calculates the reference elevation difference in real time, click [Next].

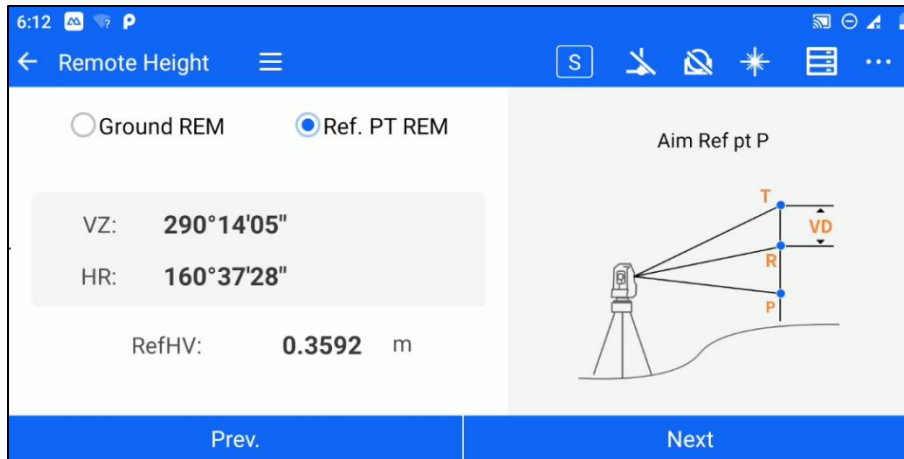

Figure 7-19

3. Aim at the target point T, and the software calculates the value of REM in real-time.

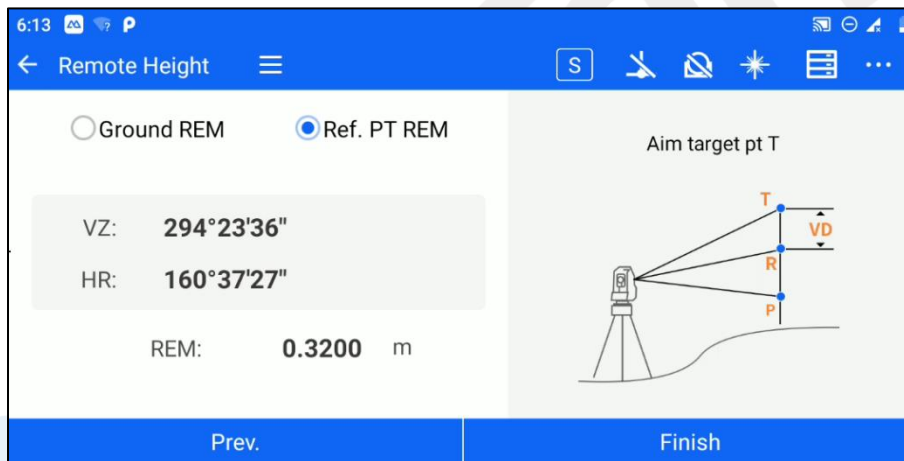

Figure 7-20

[Prev.]: Return to the previous step, you can view the previous measurement information.

[Finish]: Restart the REM

7.7 Line & Extension Point

When the point to be measured is on the line of two measurable points and the distance from the point to be measured to the last measurement point is known, the [Line&Extend Point] (two distance Offset) function can be used for calculation. Enter the measurement interface through [Collection] - [Line&extend point]. The operation steps are as follows.

1. Users enter [Line&Extend Point], enter the extension distance, and click [OK].

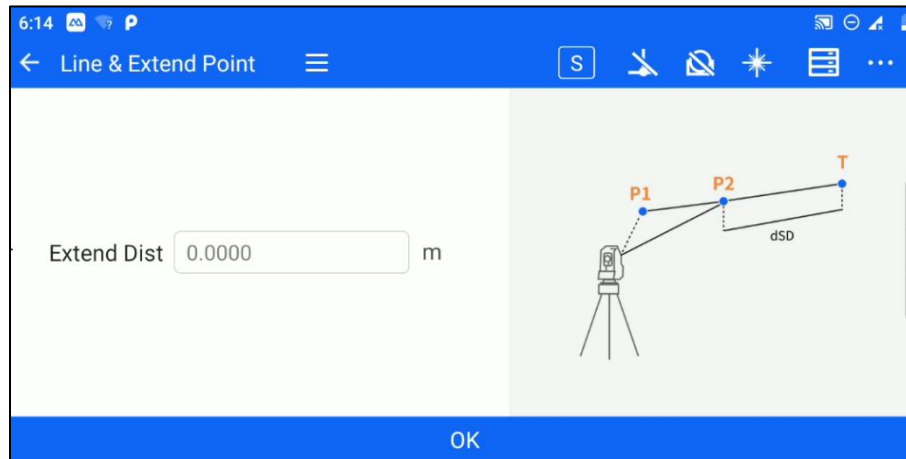

Figure 7-21

2. Enter the target height, aim at the starting point, click [Meas.], get the angle and distance measurement data, and click [Next].

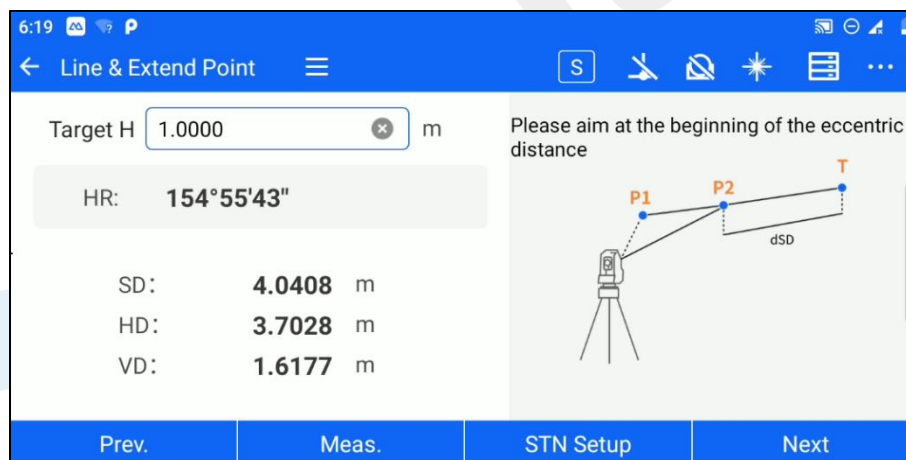
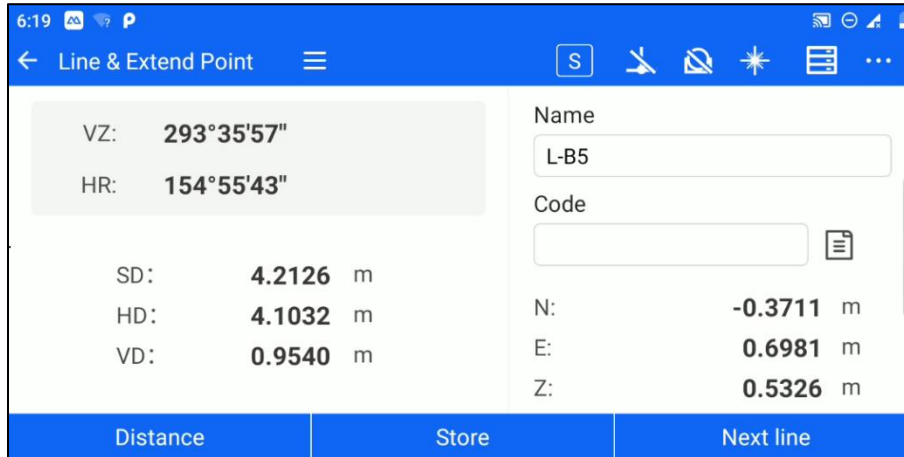

Figure 7-22

3. The software displays the calculated coordinates of the target point, click on the distance to reset the distance value, and the coordinates of the extension point can be calculated.



The screenshot shows a mobile application interface titled "Line & Extend Point". It displays the following data:

VZ:	293°35'57"
HR:	154°55'43"
SD:	4.2126 m
HD:	4.1032 m
VD:	0.9540 m

On the right side, there are input fields for "Name" (containing "L-B5") and "Code". Below these are the coordinates for a point:

N:	-0.3711 m
E:	0.6981 m
Z:	0.5326 m

At the bottom, there are three buttons: "Distance", "Store", and "Next line".

Figure 7-23

[Store]: Store the target points obtained by calculation in the point library.

[Next line]: You can recalculate the next point from step 1.

7.8 Line & Angle

When the point to be measured is on the line of two measurable points, but the distance relationship between the point to be measured and the measurable point is not known, you can use the [Line&Angle point] function for calculation. Enter the measurement interface through [Collection] - [Line&Angle point]. The operation steps are as follows.

1. Enter the target height, aim at the starting point of the straight line, click [Meas.], get the angle and distance measurement data, and click [Next].

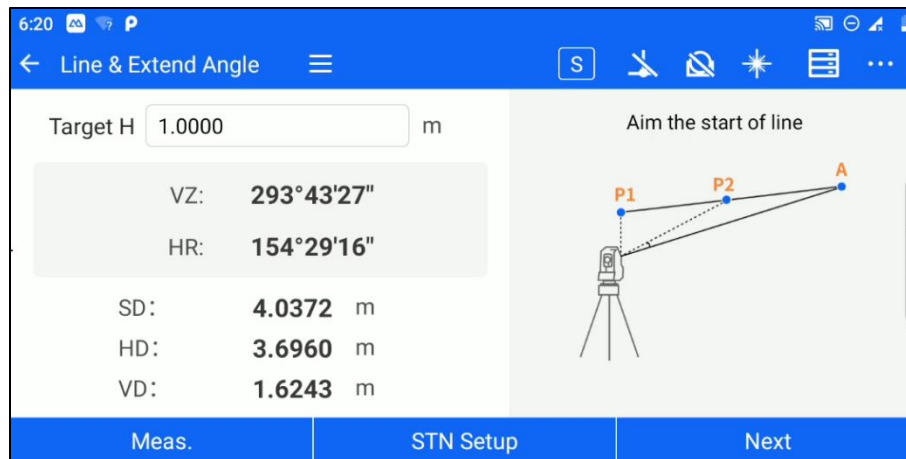

Figure 7-24

2. Enter the target height, aim at the end point of the straight line, click [Meas.], get the angle and distance measurement data, and click [Next].

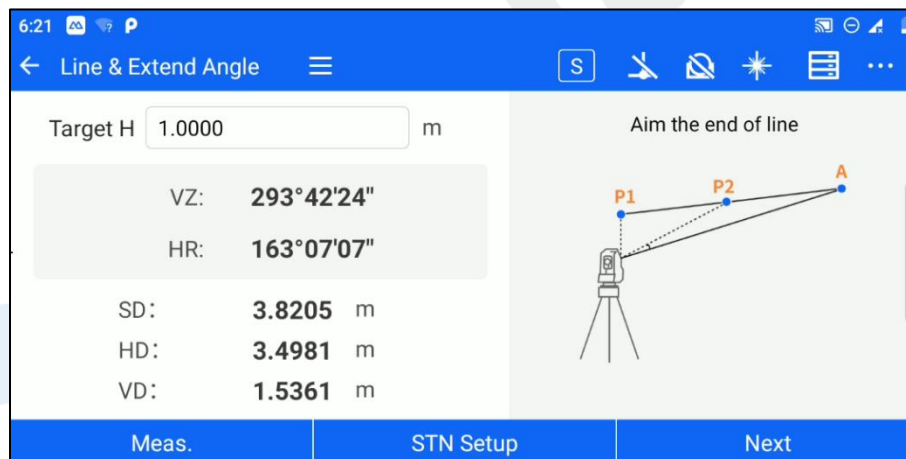
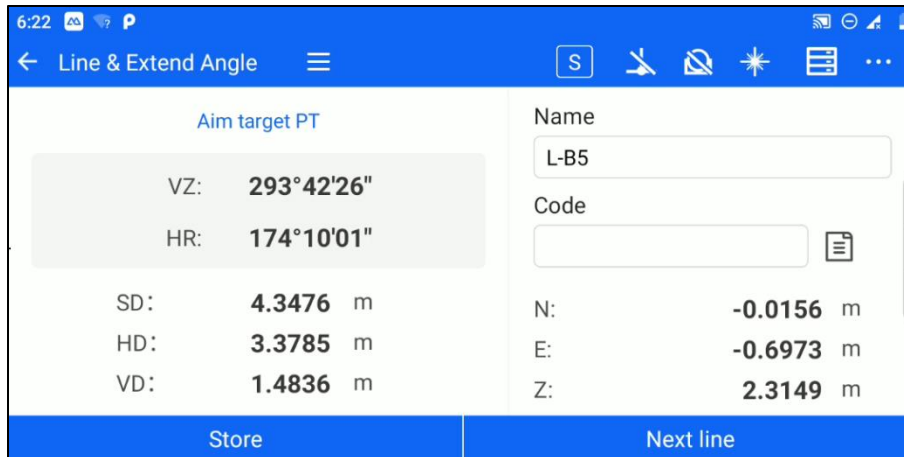

Figure 7-25

3. Aim at the target point, and the software displays the calculated coordinates of the target point.



Aim target PT	
VZ:	293°42'26"
HR:	174°10'01"
SD:	4.3476 m
HD:	3.3785 m
VD:	1.4836 m

Name	<input type="text" value="L-B5"/>
Code	<input type="text"/>
N:	-0.0156 m
E:	-0.6973 m
Z:	2.3149 m

Store	Next line
-------	-----------

Figure 7-26

[Store]: Store the target points obtained by calculation in the point library.

[Next line]: You can recalculate the next point from step 1

Chapter 8

Stakeout program

This chapter contains:

- CAD
- Point S.O
- Image
- Angle & Dist.
- Directional Line
- Straight Line
- RefLine
- RefArc



8.1 CAD

CAD stakeout allows you to select features from imported dxf and dwg format files and perform point stakeout and line stakeout on the selected features.

8.1.1 CAD Data Import

Click [Stake out] → [CAD] to enter the CAD stakeout interface, expand the right toolbar, click the [Data]  button to enter the CAD data interface, click the [Importing files] button below to select and import CAD data, and import data support *. dxf, *.dwg format, select the data and click OK to jump to the CAD stakeout interface and display the data content.

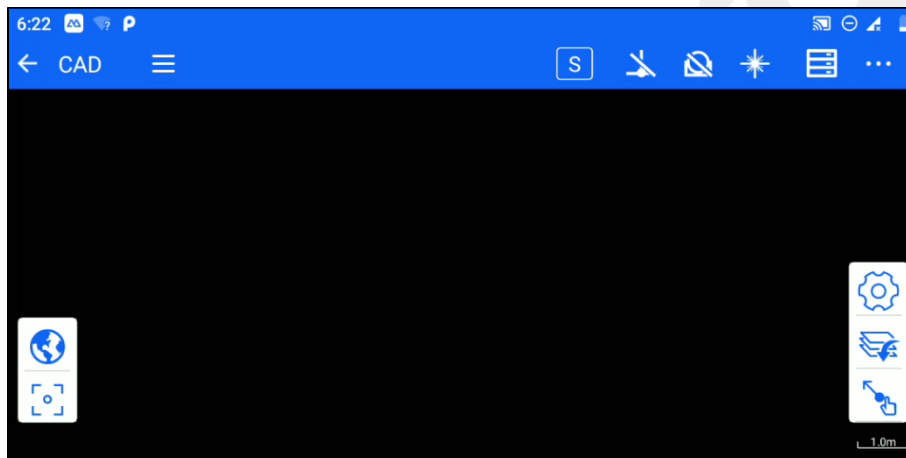

Figure 8-1

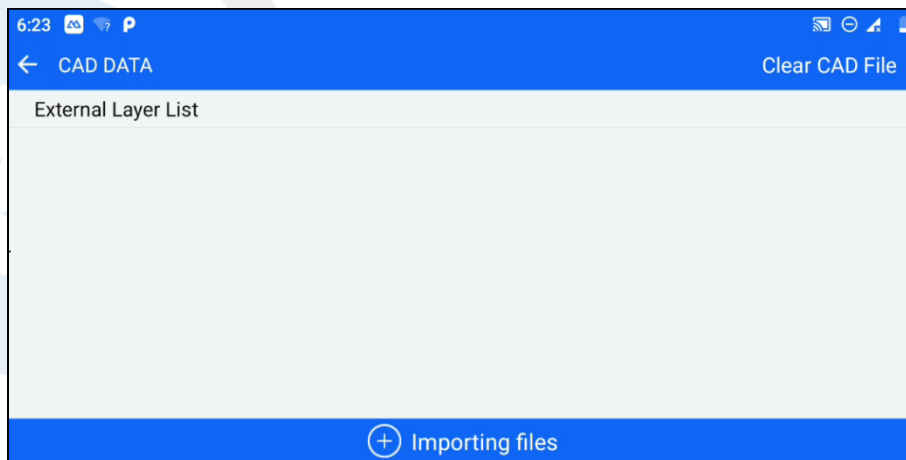

Figure 8-2

8.1.2 Layer Display

Click the [DATA]  button in the CAD stakeout interface to enter the data interface, and control the

display of the corresponding layer by the eye in front of the layer, the layer is displayed when the eye is open, and the layer is not displayed when the eye is closed.

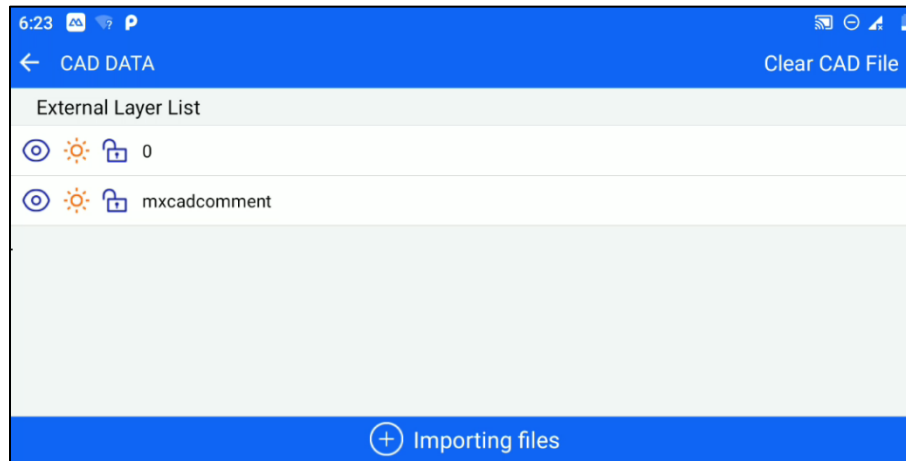



Figure 8-3

8.1.3 Delete Base Map

After importing external data, click the [DATA]  button in the CAD stakeout interface to enter the data interface, click the [Clear CAD File] button in the upper right corner of the interface, and a pop-up window will appear to indicate whether to confirm the deletion of the CAD base map file, click OK to clear the base map.

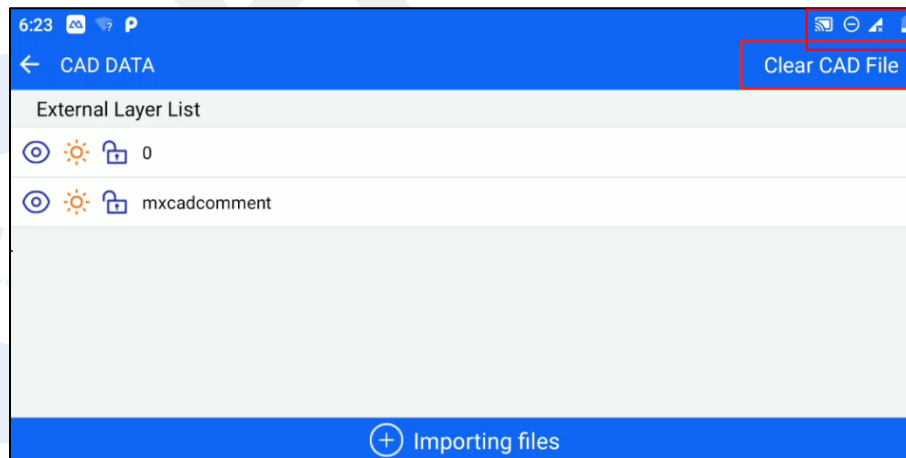

Figure 8-4

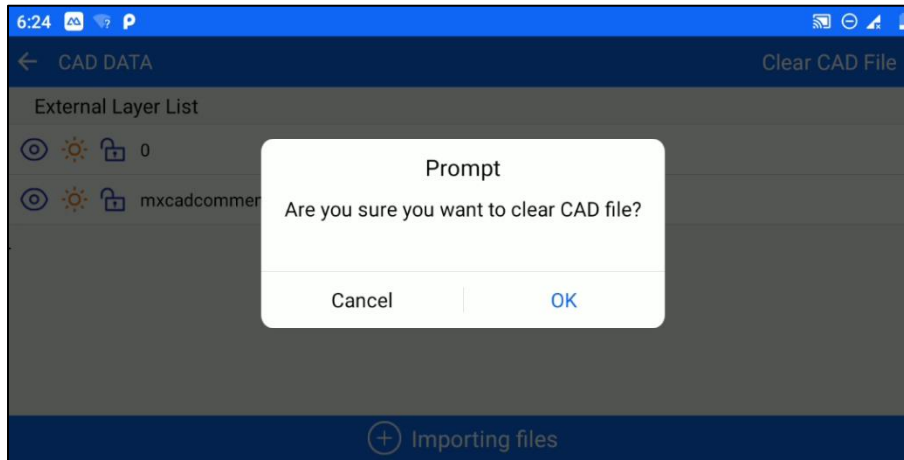

Figure 8-5

8.1.4 Open the Last Base Map

After you have opened the CAD Base Map file, the next time you enter the CAD stakeout module, a pop-up window will prompt you whether to open the last file, if you click Open, the last file will be loaded; otherwise, it will not be loaded.

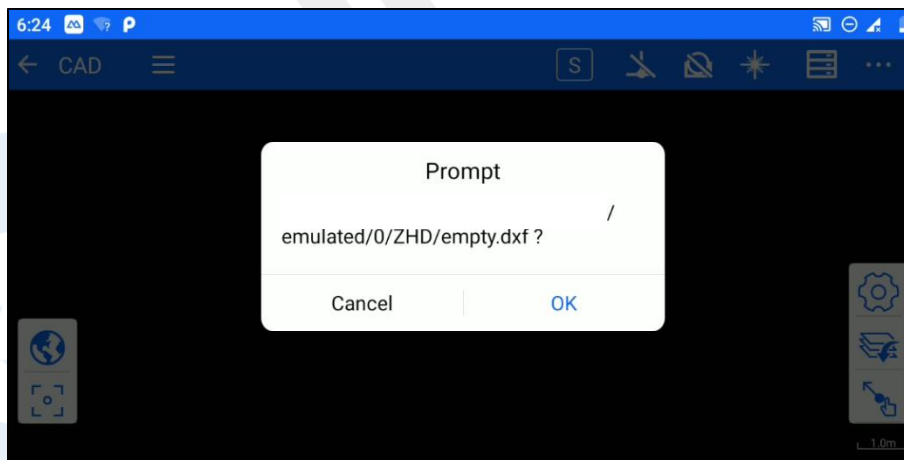



Figure 8-6



Note: 1. When switching between projects and the New function is performed, the CAD stakeout screen correctly displays the imported data and is not affected.

8.1.5 CAD Stakeout Tool

When you enter the CAD Stakeout interface, click on the Settings  button in the right toolbar to expand the CAD module's related tools.

 Font size: You can modify the dot name size of the acquisition points in the CAD stakeout interface.

 Toggle Base Map: You can toggle the base map to black/white.

 Switch coordinate system: Click this button to switch between displaying the user coordinate system or the world coordinate system.

 Conversion of base map source length units: You can convert the base map source length units to m or mm.

 Redraw: When the interface is enlarged, there may be a phenomenon that the arc is not drawn smoothly, click Redraw to refresh it to make it draw correctly.

 Blow up the entity: you can blow up the selected feature into multiple entities. The operation method is.

1. After loading the CAD file, click on the graphical interface to select the block or polyline.

2. Click , the selected block can be blown up into multiple independent entities.

8.1.6 Line stakeout

1. Import the CAD files that need to be stakeout

2. Click to select the target line to be stakeout, and display the "stakeout"  button.

3. Click the "stakeout"  button to enter the stakeout parameter setting interface, you can set the stakeout parameters such as left/right offset, front/back offset, front/back offset increment, top/bottom offset, etc.



Figure 8-7



Figure 8-7

The default checkbox of "stakeout line node" in the setting interface of stakeout parameters means that the stakeout target can also be switched to the node of the stakeout line when it is switched by the increment of front and rear offset; if the checkbox of stakeout line node is unchecked, the stakeout point will only be switched by the integer multiple of the increment of front and rear offset and will not be switched to the node of the stakeout line.

Click OK to enter the stakeout interface, click the last point and next point button to switch the target points by front and back offset increments, click the measurement and storage/measurement- Store to calculate the stakeout information, and expand the graphic interface on the right to display the position relationship between the current position, prism points, and stakeout points.

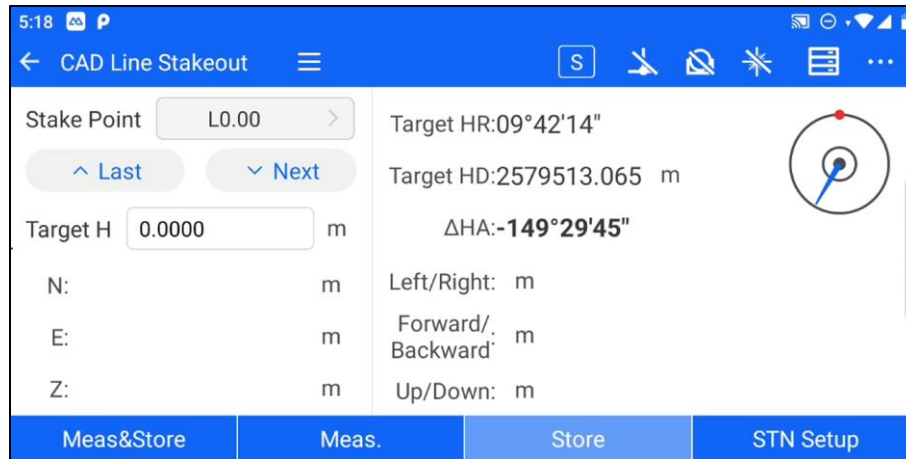

Figure 8-8

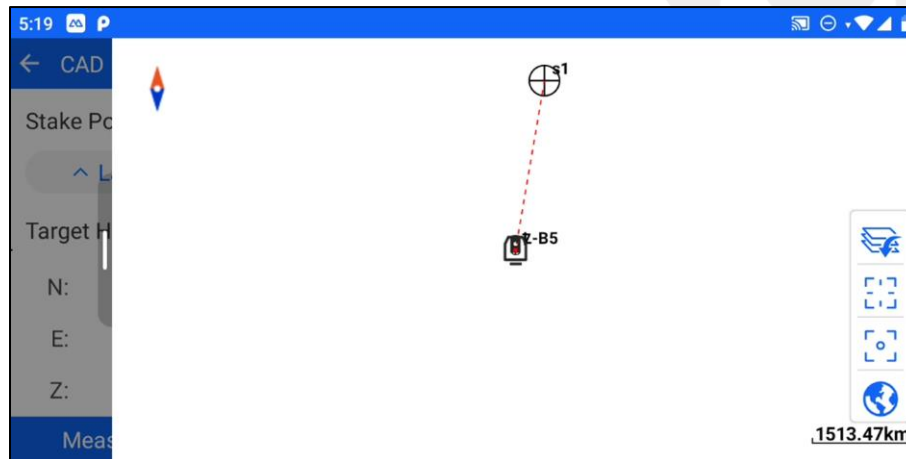





Figure 8-8

8.1.7 CAD Point Stakeout

For CAD interface graphics, you can use the [Select Point]  button to select special marker points and click OK after successful selection to stake out the selected points.

The special marker points that can be selected are line start point, line endpoint, line node, any point on a circle arc, and any point on a circle. The operation steps are as follows.

1. Enter the [CAD], click "Select point" , and the interface shows the pick mark.
2. Drag the pick marker to the special marker point to be selected, stakeout the pick marker and click the "stakeout"  button.

- Pick up the stakeout point successfully, and jump to the stakeout interface to start the stakeout.
- The total station aim at the prism, and then clicks the meas&store/meas.- Store to calculate the stakeout information, according to which the prism can be moved to the position to be stakeout.

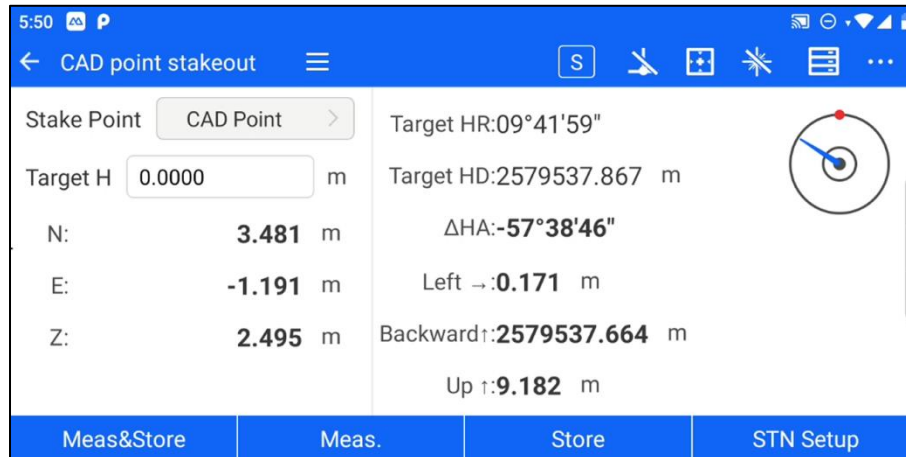

Figure 8-8

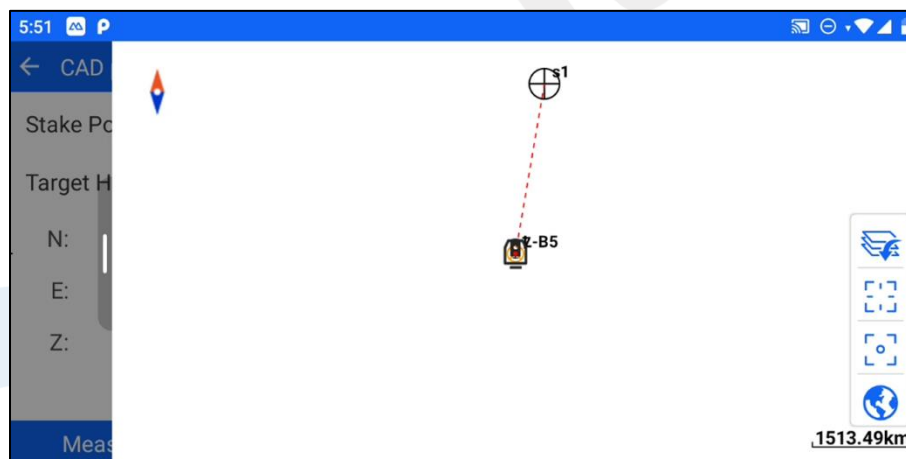

Figure 8-9

8.2 Point S.O

The coordinates stakeout can be selected by the point library or manually entered to select a certain stakeout point for the stakeout operation.

The operation steps are as follows.

- Enter [Point S.O], and click "Select Stake PT " to jump to the interface of "Select Stake Point", you

can select the target points to be stakeout by manual input or list selection of points.

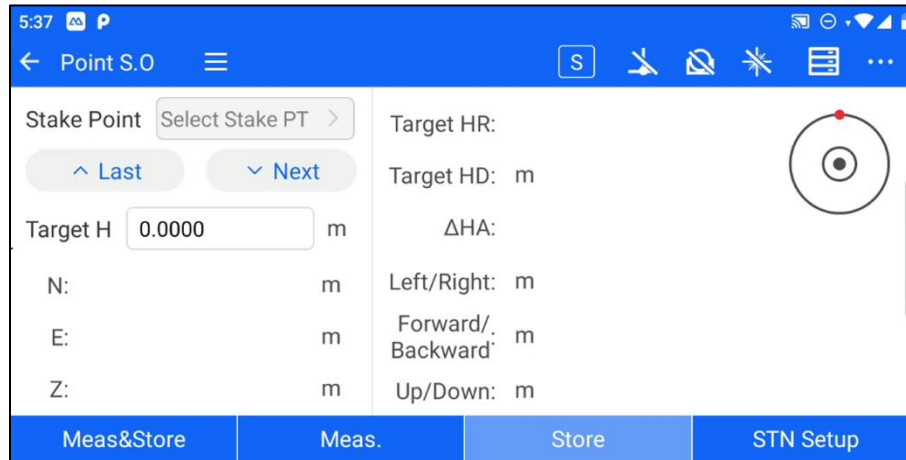

Figure 8-10

2. After selecting the stakeout point, click OK, return to the stakeout interface, and click the previous point and next point buttons to switch the point data in the stakeout point library for stakeout.

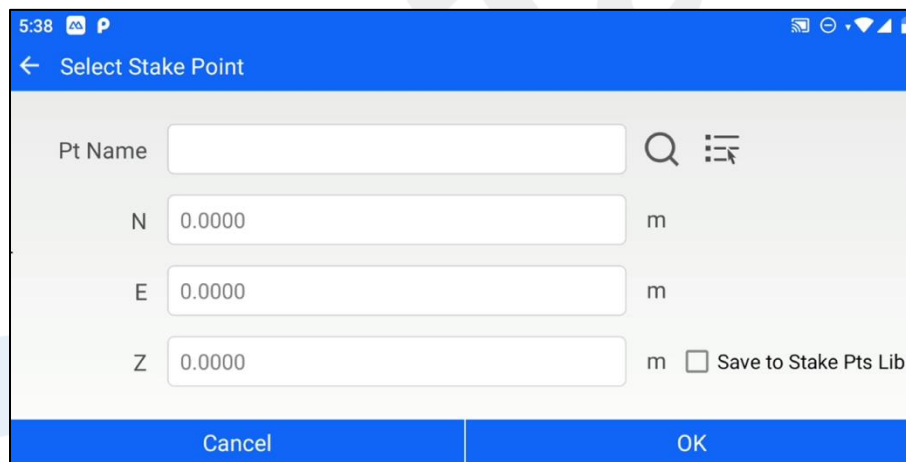

Figure 8-11

3. The total station aim at the prism, click on the meas&store/meas.- Store to calculate the stakeout information, and refer to the stakeout information tips to find the stakeout position.

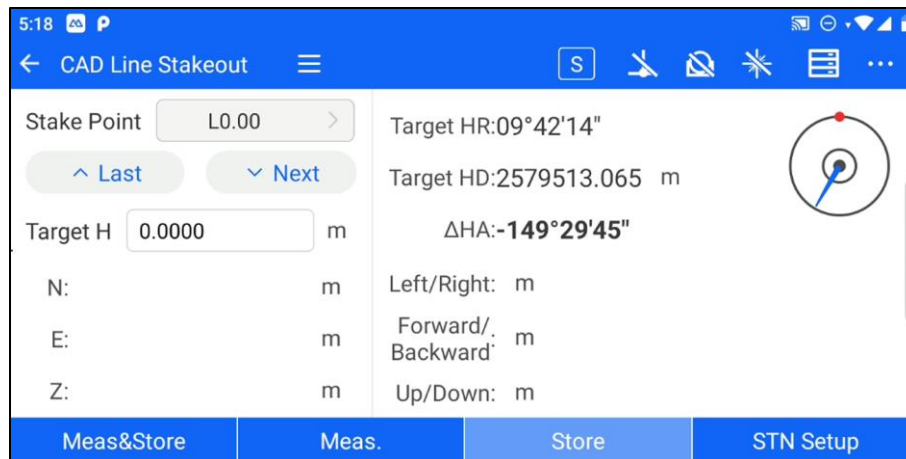

Figure 8-12

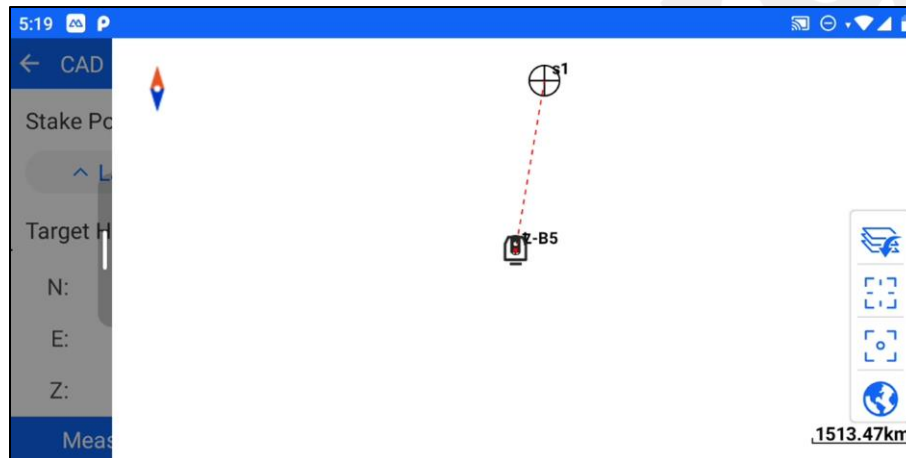

Figure 8-13

8.3 Image

The total station is equipped with an image function, which will display the camera view on the screen. When the stakeout point is set, it will mark the location of the stakeout point on the interface and perform the stakeout prompt to the left/right and up/down. So that it is easier to find the point to be stakeout.

The module can be accessed through [Stakeout Program] - [Image Assisted Stakeout]. It should be noted that image-assisted stakeout is only supported on the total station. Other Android devices do not show this option.

The operation steps are as follows.

1. Enter [Image Aided Stakeout], open the left slide bar, and click Set Stakeout Point. Same as other setting stakeout points, you can select the stakeout points by manual input, point name search, list selection, etc.

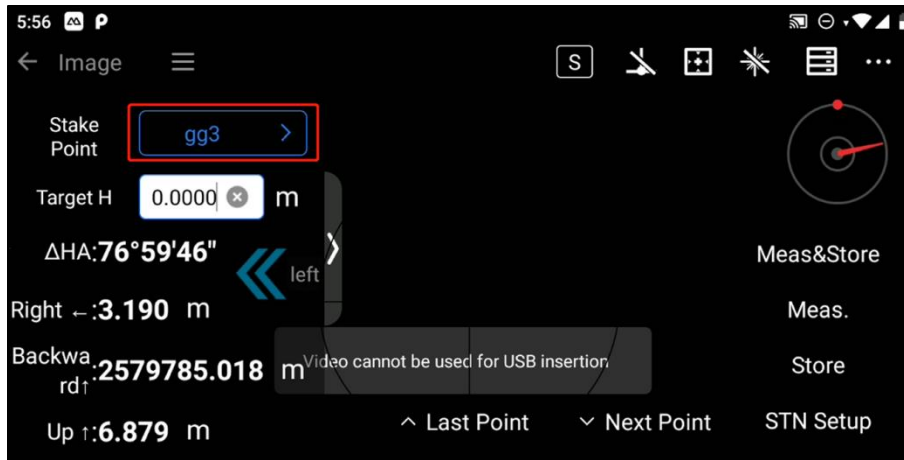

Figure 8-14

2. After selecting the stakeout point, the graphical interface shows the hints to the left/right and up/down; the side slider also shows the stakeout distance hints.

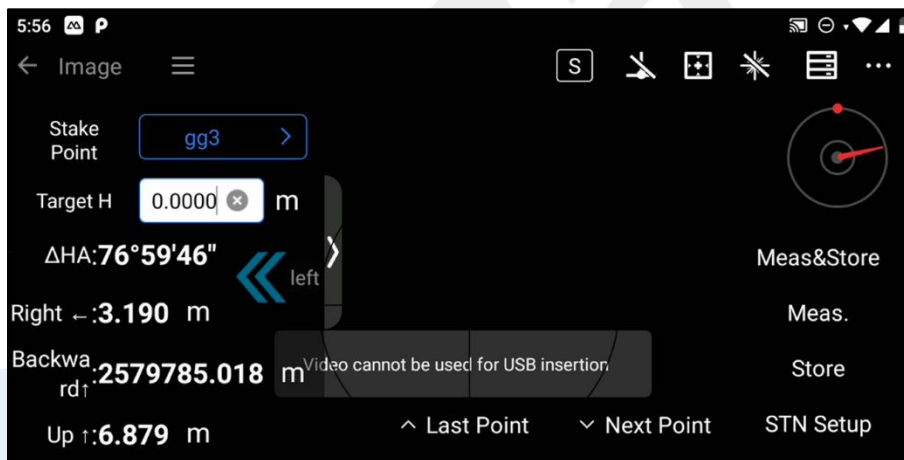

Figure 8-15

3. According to the instructions to turn the eyepiece, when the target point is in the visual range, you can see a red mark on the target point. It is convenient to take a picture and put the sample.

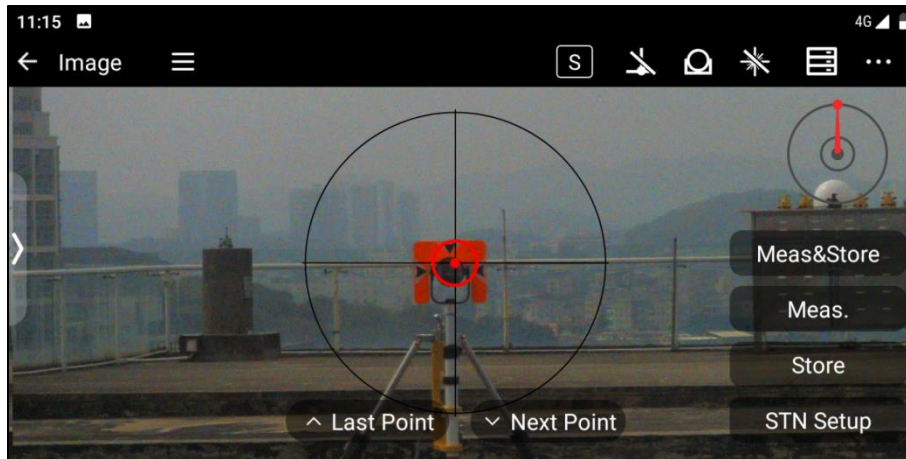

Figure 8-16

[Meas&store]: While measuring prism points, save prism point information to the total station point library.

[Meas.]: Measure the coordinates of the prism point.

[Store]: When the coordinates of the prism points have been measured, click Store to save the prism point information to the total station point database.

[STN Setup]: Jump to the station Backsight screen to reset the station.

[Last point] / [Next point]: Switch to select the stakeout point in the stakeout point library.

8.4 Angle&Dist.

Angle distance stakeout can be set by entering the horizontal angle, Angle flat distance, and elevation difference from the stakeout point to the survey site.

Click [Angle Distance Stakeout] to enter the Angle distance setting interface, and set the horizontal angle, Angle distance, and elevation difference from the stakeout point to the survey site.

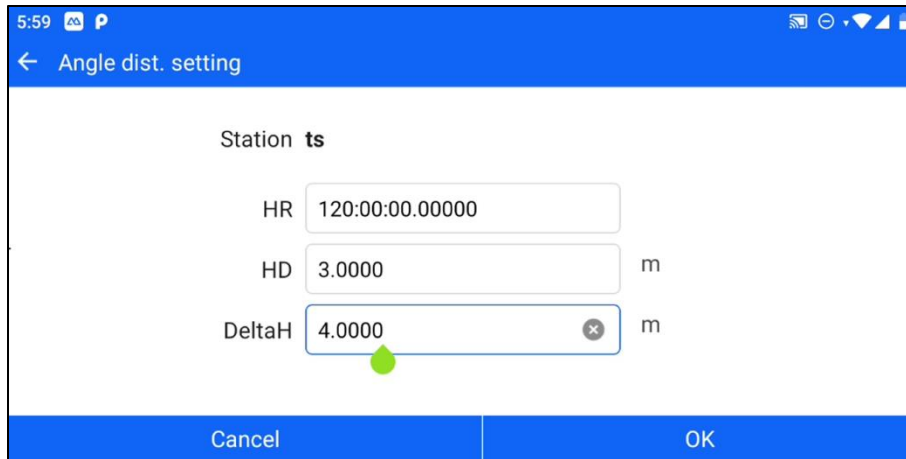

Figure 8-17

Click OK to jump to the angle and distance stakeout interface, and click angle and distance parameters to modify and adjust the stakeout point setting parameters. Click Save/Measure/ Store to display the stakeout information, and move the prism according to the stakeout information to reach the target location of the stakeout point.

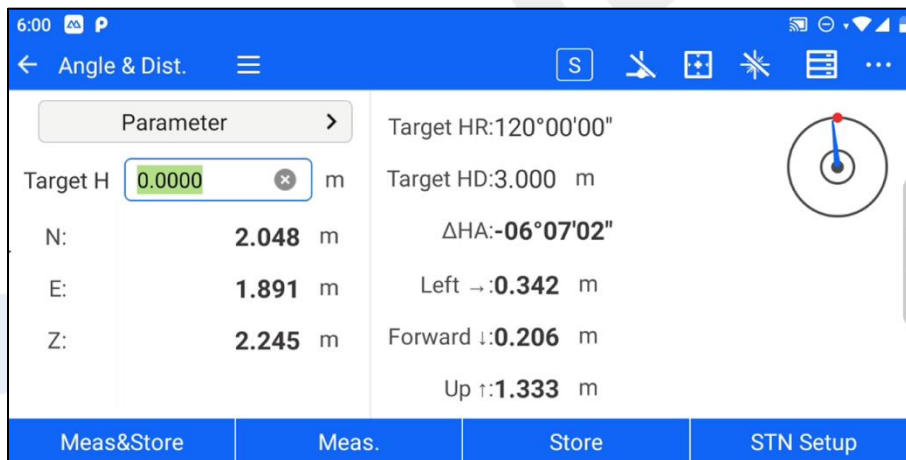

Figure 8-18

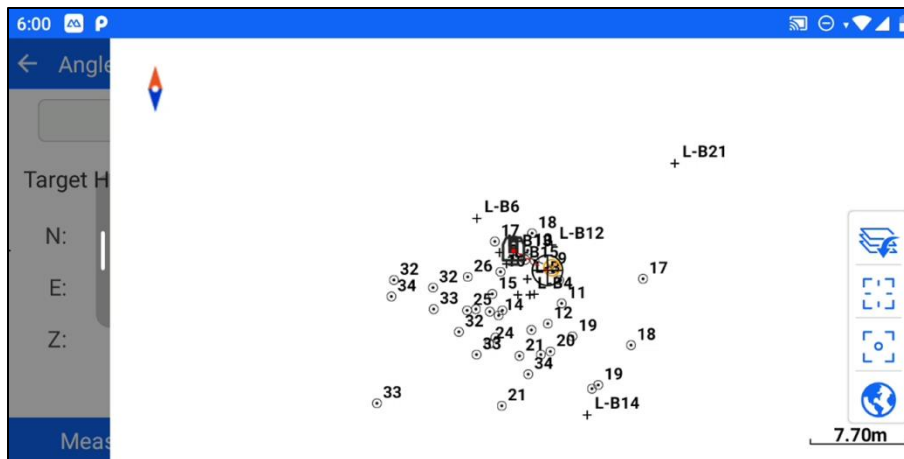

Figure 8-19

8.5 Directional Line

Directional line Stakeout can be set by inputting azimuth, level distance, and elevation difference from reference point to reference point to set the Stakeout point for Stakeout.

Click [Directional Line setting] to enter the directional line parameter setting interface, after selecting the reference point (the reference point can be selected by manual input, list selection, measurement selection, etc.), set the azimuth, flat distance, and elevation difference from the sample point to the reference point.

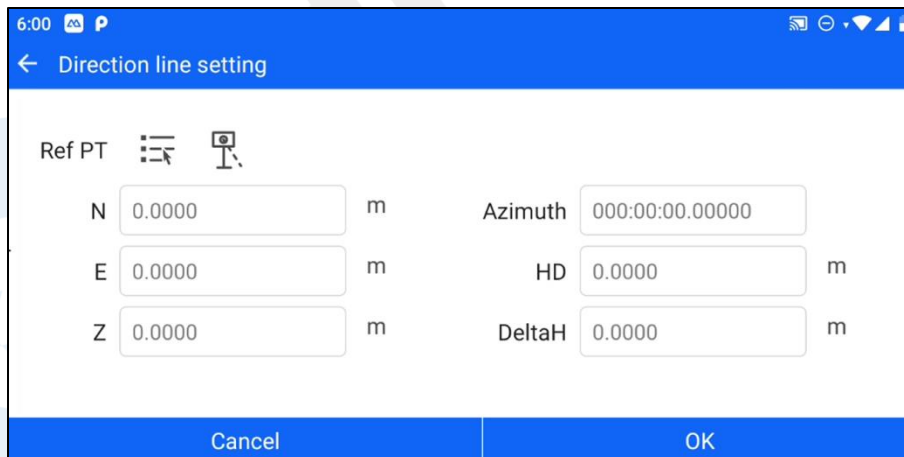

Figure 8-20

Click OK to jump to the interface of the directional line, and click on the directional line parameters to modify and adjust the parameters of the reference point settings. Click Save/Measure/ Store to display the stakeout information, and move the prism according to the stakeout information to reach the location of the stakeout point.

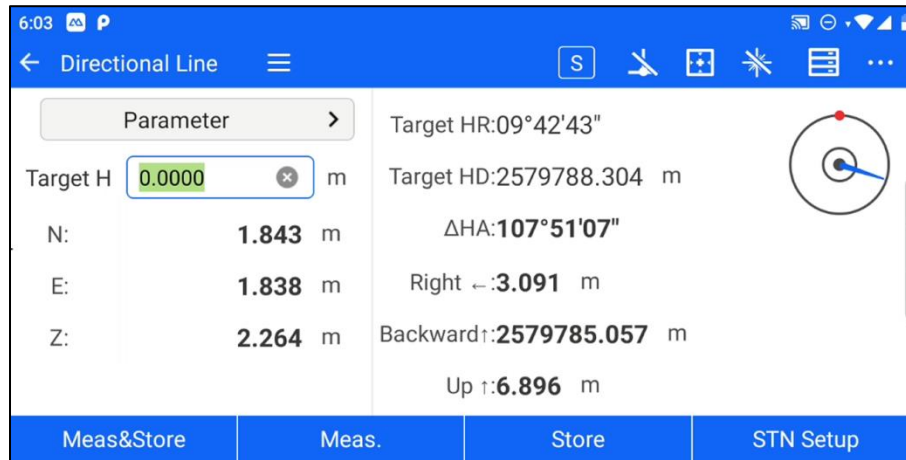

Figure 8-21

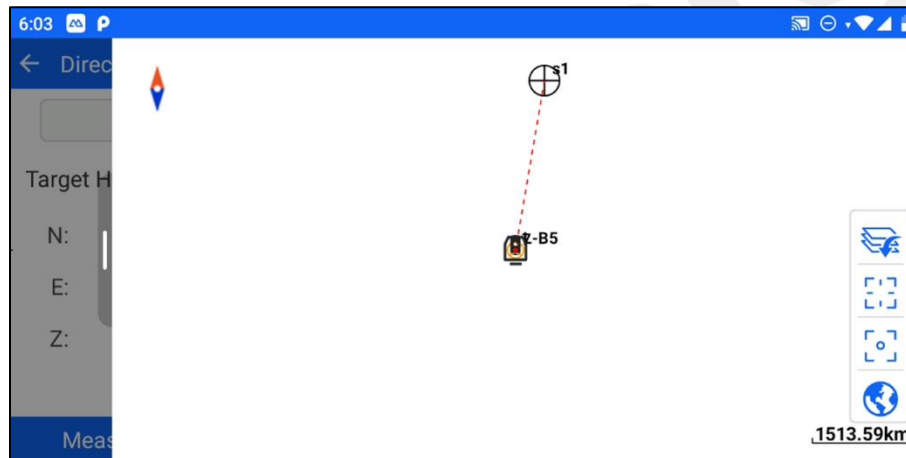

Figure 8-22

8.6 Straight Line

Straight Line Placing allows you to place custom lines by setting the placing parameters.

Click [Straight Line] to enter the line definition interface, and set the starting point and end point to create a custom line.



Figure 8-23

After setting the line, click OK to enter the setting interface of stakeout parameters, you can set the stakeout parameters such as left/right offset, front/back offset, front/back offset increment, top/bottom offset, etc. Click OK to enter the line stakeout interface.



Figure 8-24

Click "Line Definition" to modify and adjust the line information.

Click the previous point and next point buttons to switch the target points according to the configuration of the stakeout parameters, click the measurement and storage/measurement- Store to calculate the stakeout information, and expand the graphic interface on the right side to display the position relationship between the current position, prism points, and stakeout points.

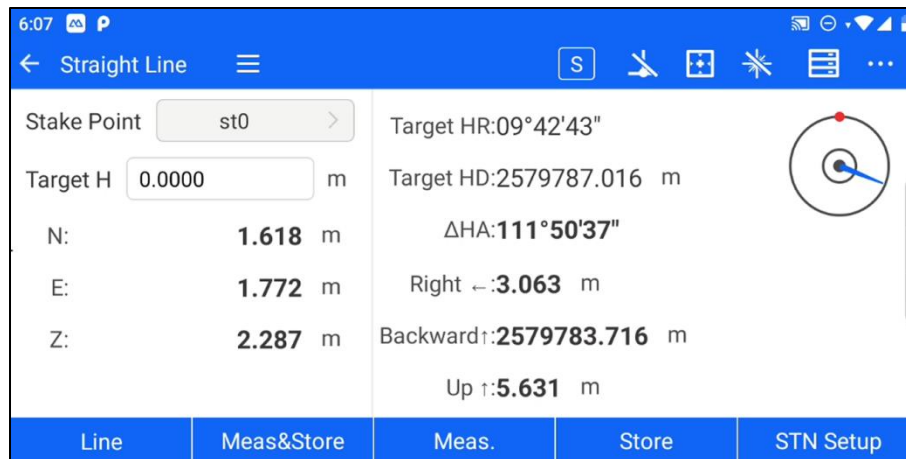

Figure 8-25

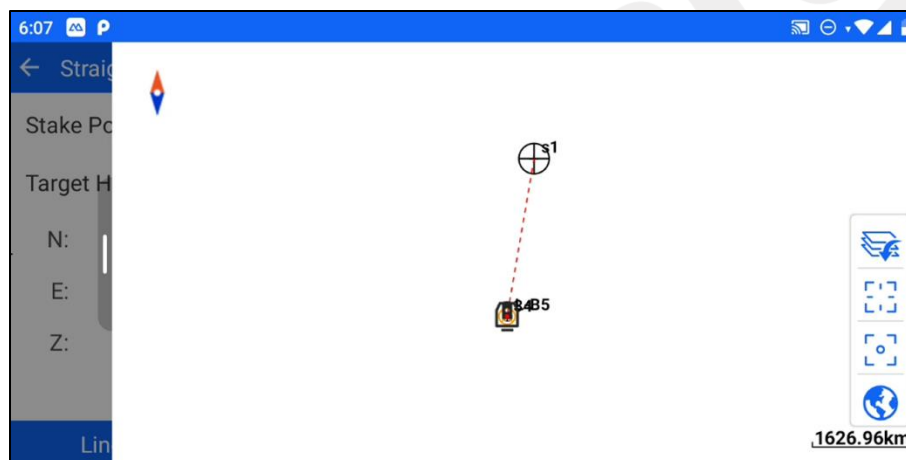

Figure 8-26

8.7 RefLine

Reference line Stakeout can define the reference line by setting parameters such as start/end point and baseline offset, rotation, etc., and perform Stakeout operations on the reference line after configuring the Stakeout parameters.

8.7.1 Reference Line Definition

Click [RefLine] to enter the reference line definition interface, select the starting point and end point of the reference line (can be selected by manual input, list selection, measurement selection, etc.); set the baseline offset, including horizontal offset, vertical offset, rotation angle, and other parameters.

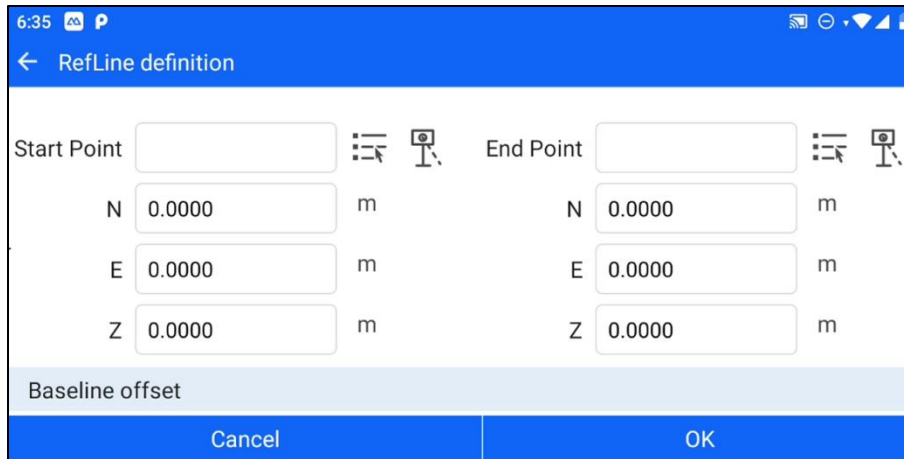

6:35 P

← RefLine definition

Start Point End Point

N 0.0000 m N 0.0000 m

E 0.0000 m E 0.0000 m

Z 0.0000 m Z 0.0000 m

Baseline offset

Cancel OK

Figure 8-27

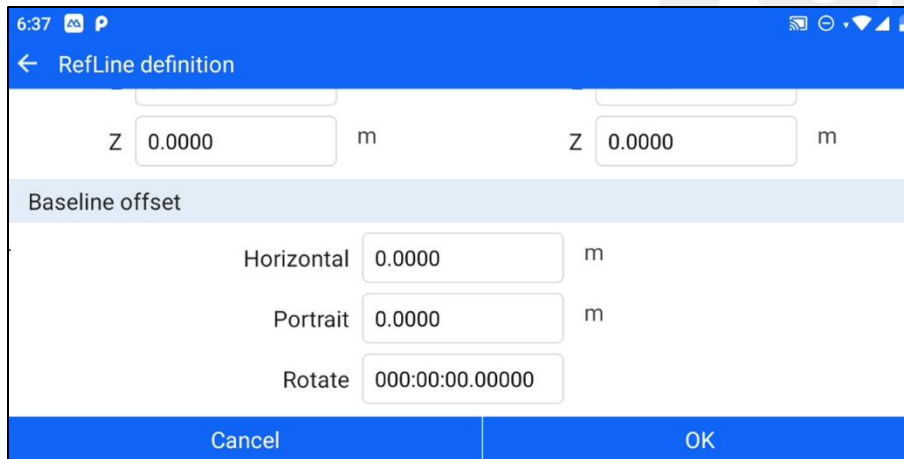

6:37 P

← RefLine definition

Z 0.0000 m Z 0.0000 m

Baseline offset

Horizontal 0.0000 m

Portrait 0.0000 m

Rotate 000:00:00.00000

Cancel OK

Figure 8-28

8.7.2 Reference Line Stakeout

After defining the reference line and its baseline offset, click OK to enter the setting interface of stakeout parameters, set the stakeout parameters such as left/right offset, front/back offset, front/back offset increment, top/bottom offset, etc., and then click OK to enter the reference line stakeout interface.



Figure 8-29

If the front and back offset increment is set, the stakeout screen shows the switch button of the previous and next point, and click it to switch the target point of the stakeout according to the offset increment.

After the target point is selected, click on the meas&storage/meas.- Store to calculate the stakeout information, and expand the graphic interface on the right side to show the position relationship between the current position, prism points, and stakeout points.

Click the "RefLine" button to jump to the reference line definition interface to modify the reference line parameters.

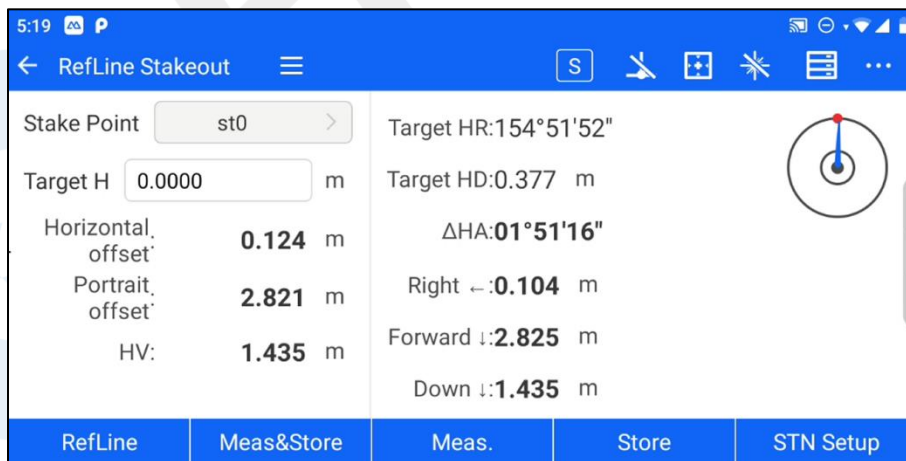

Figure 8-30

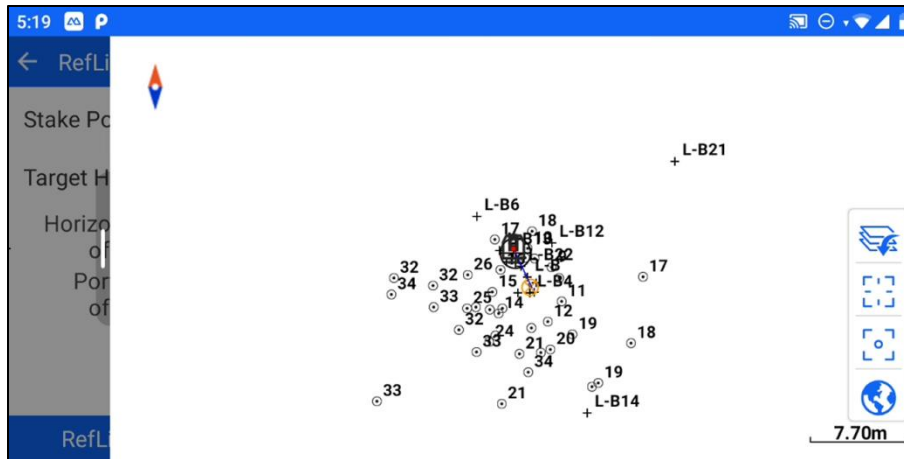

Figure 8-31

8.8 RefArc

The reference arc stakeout can be defined in different ways, and the stakeout operation can be performed on the reference arc after configuring the stakeout parameters.

8.8.1 Reference Arc Definition

Click [RefArc] to enter the reference arc definition interface, there are three reference arc definition methods to choose from: "center + start PT", "Start PT + End PT + radius", "Start PT+ End PT + PT on the arc ", after selecting the reference arc definition method, you can set the parameters as required.

After "Center + StartPT" or " Start Pt + End Pt + Point on Arc", click the "Calculate" button to automatically solve the reference arc radius information.

After inputting the reference arc information, click OK to jump to the setting interface of the stakeout parameters.

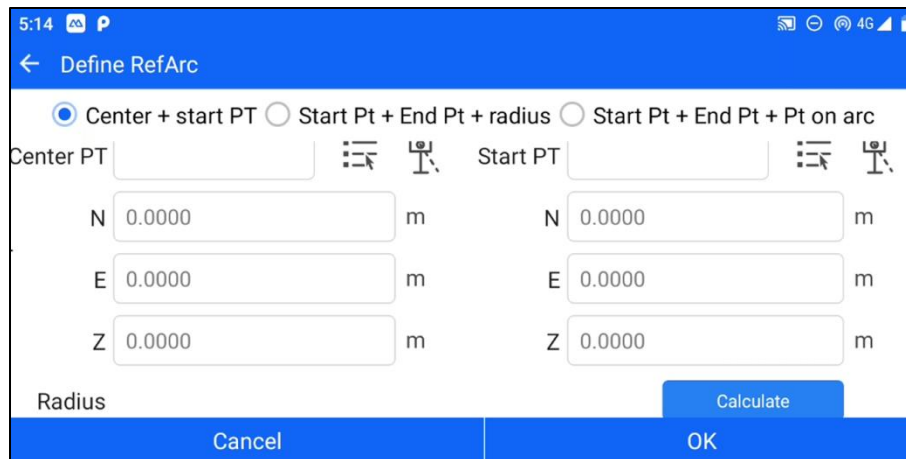

Figure 8-32

Note: 1. When using the "Center + start PT" and "Start + End + Point on Arc" methods to calculate the radius of the reference arc, only the 2D projection coordinates are considered, i.e. the radius is calculated in the 2D plane, independent of the Z coordinate of the reference point.

2. The graphical interface draws a 2D planar graph of the reference arc, but the elevation information of the reference point is still retained and effective when the stakeout operation is performed.

3. When using the "Start + End + Top" method to set the reference arc, the top point of the arc is always between the start and endpoints.



8.8.2 Reference Arc Stakeout

Enter the setting interface of stakeout parameters, you can select different stakeout targets and set their corresponding stakeout parameters.

Stakeout point

Select the stakeout point item, set the arc distance, diameter distance, and other parameters, and then click OK to jump to the reference arc stakeout interface, click Save/Measure- Store to calculate the stakeout information, and expand the graphic interface on the right to display the current position, prism points and the position relationship between the stakeout points.

Arc distance "line": set to a , then the arc distance a is offset clockwise starting from the starting point in the reference arc, and $0 < a < \text{total arc length}$.

Diameter distance "offset": set to b. If $b < 0$, the distance b will be approached the center of the circle starting from the starting point; if $b > 0$, the distance b will be moved away from the center of the circle starting from the starting point.

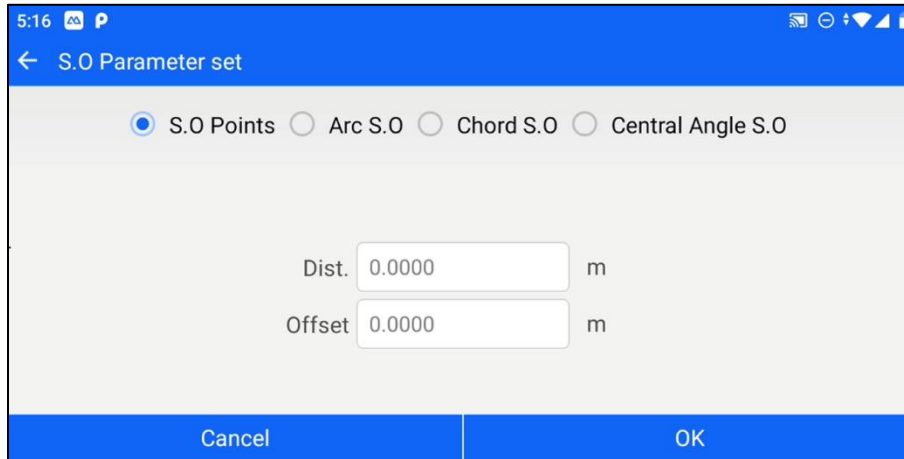

Figure 8-33

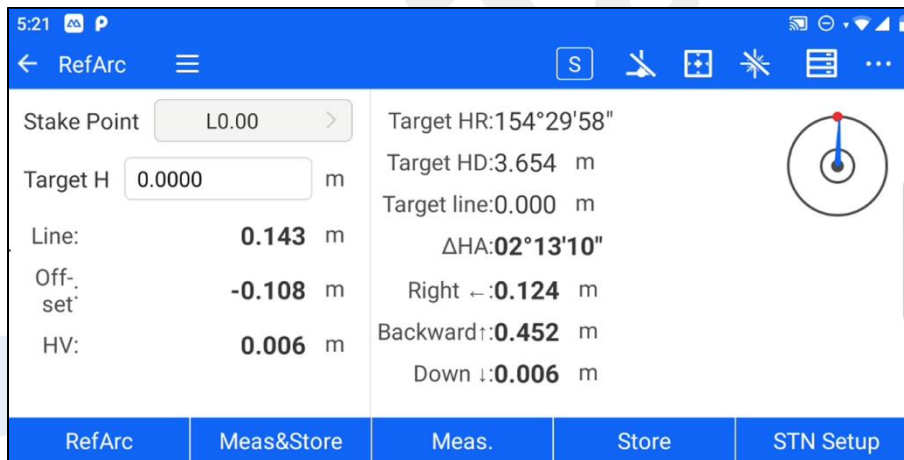

Figure 8-34

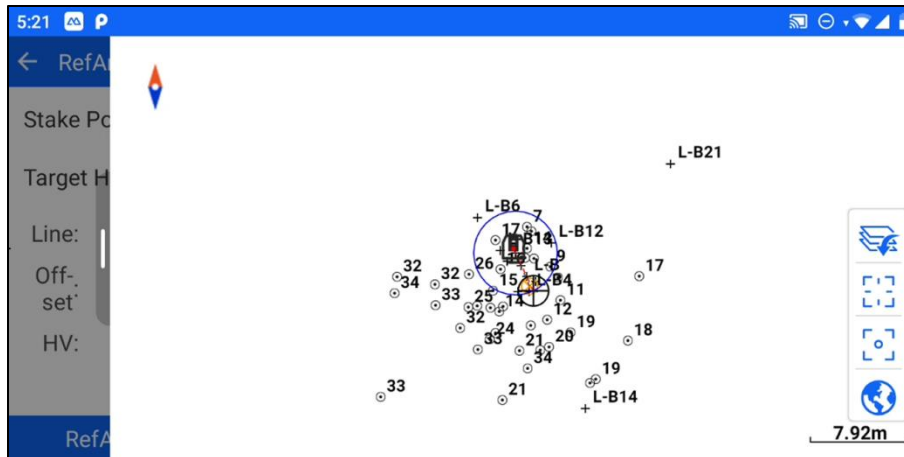

Figure 8-35

Stakeout arc

Select the arc stakeout item, set the closing difference, starting arc distance, diameter distance, arc increment, and other parameters, and then click OK to jump to the reference arc stakeout interface, click Save/Measure- Store to calculate the stakeout information, and expand the right graphical interface to display the current position, prism points, and the position relationship between the stakeout points.

Closure Difference "Misclosure": including three modes of endpoint closure difference, evenly divided closure difference, and endpoint closure difference. If the endpoint mode is selected, the remainder of the total arc length/arc increment when the stakeout point switching is performed is attributed to the last stakeout point, and so on for other modes.

Starting arc distance "Start line": set to c , then the starting stakeout point is the position in the reference arc after the starting point is offset clockwise by arc distance c , and $0 < c < \text{total arc length}$.

Diameter distance "Offset": see the parameters of the stakeout point item.

"Arc Increment": set to d , then the stakeout interface can switch the stakeout point in steps of arc increment d via the Previous Point Next Point button, and $0 < d < \text{total arc length}$.

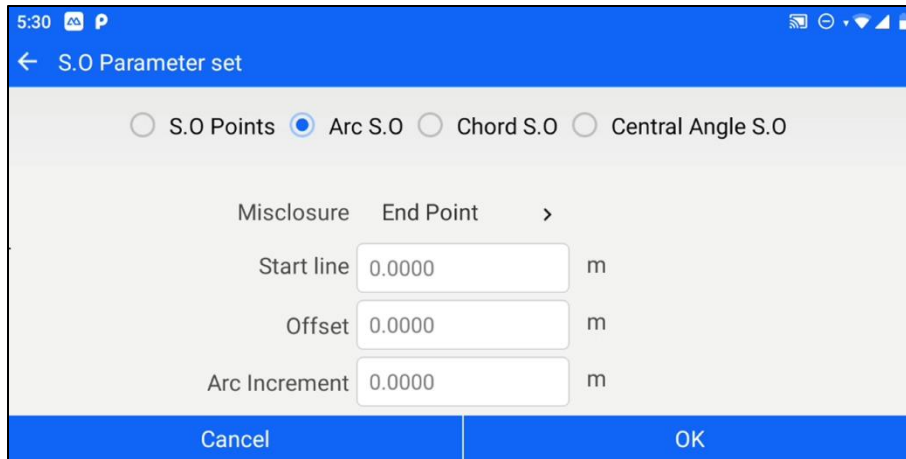

Figure 8-36

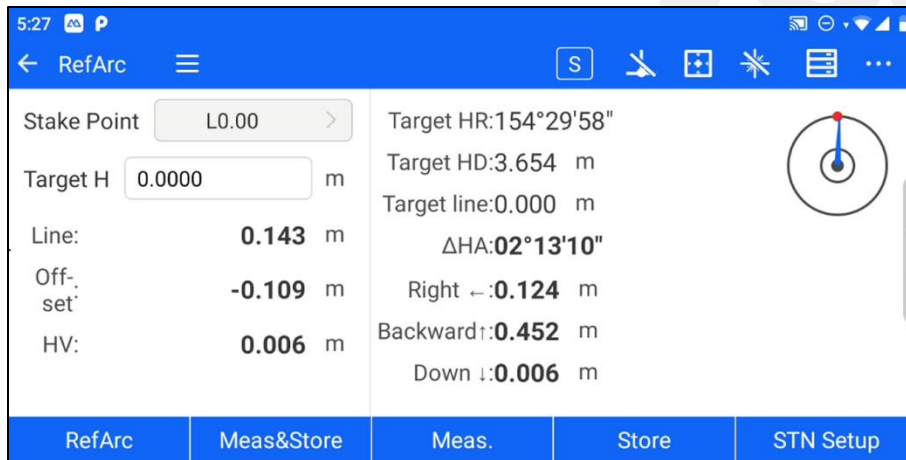

Figure 8-37

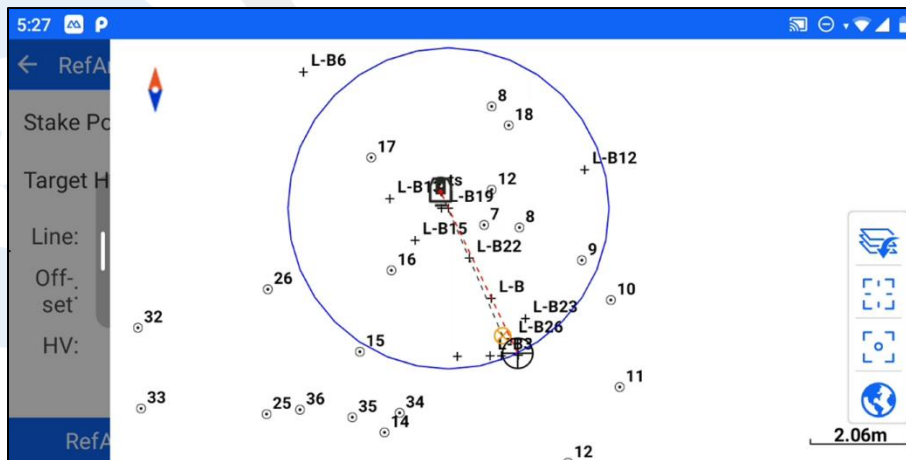

Figure 8-38

Stakeout chord

Select the chord item, set the closing difference, starting chord length, diameter distance, chord increment, and other parameters, and then click OK to jump to the reference arc stakeout interface, click Save/Measure/ Store to calculate the stakeout information, and expand the graphic interface on the right to display the current position, prism points and the position relationship between the stakeout points.

"Misclosure ": see the parameters of the stakeout arc term.

"Start chord length": set to e , then the starting stakeout point is the position of the starting point in the reference arc clockwise offset from the chord length e corresponding to the arc length, and $0 < e < \text{diameter}$.

"Offset": see the parameters of the stakeout point item.

"Chord increment": set to f , then the stakeout interface can switch the stakeout point in steps of chord increment f by the up point down point button, and $0 < f < \text{diameter}$.

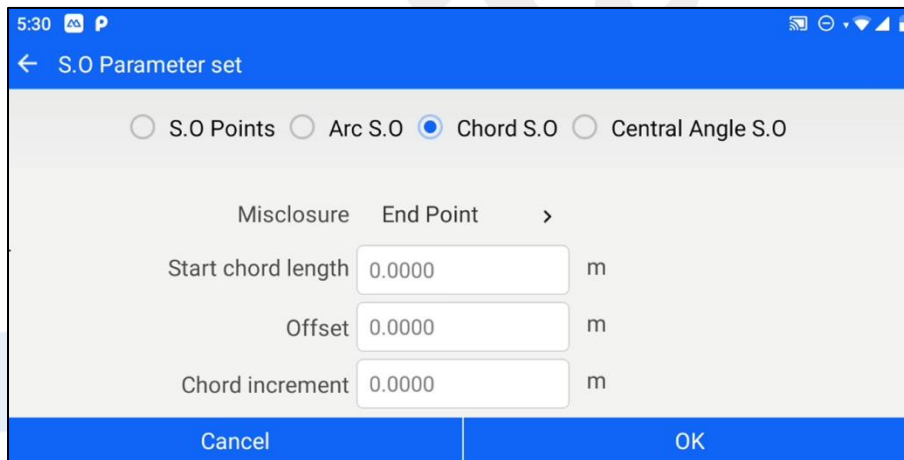

Parameter	Value	Unit
Misclosure	0.0000	m
Offset	0.0000	m
Chord increment	0.0000	m

Figure 8-39

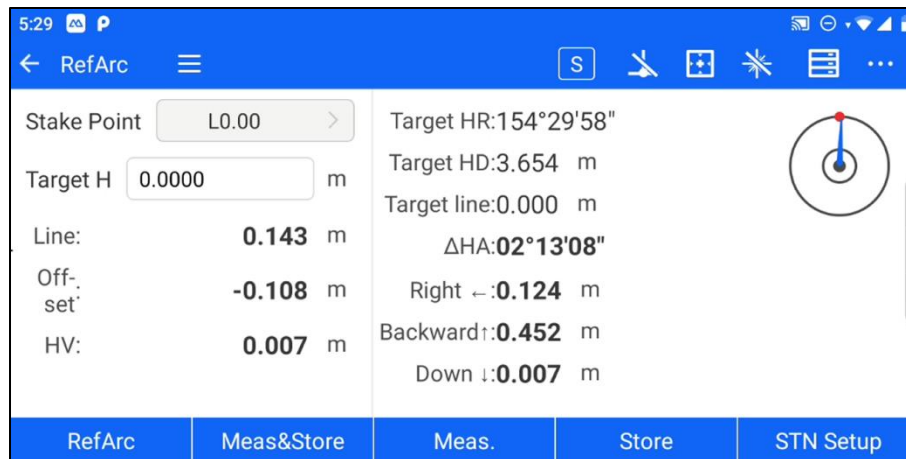

Figure 8-40

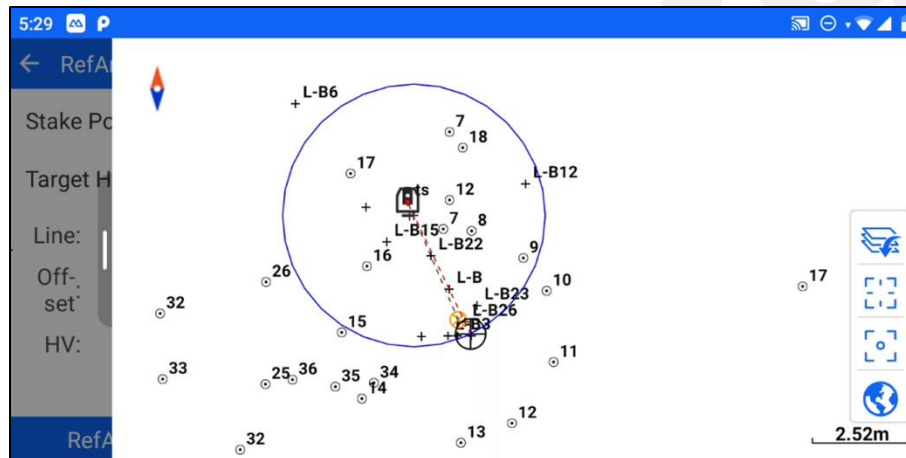

Figure 8-41

Stakeout sample rounding angle

Select the stakeout center angle item, set the closing difference, starting center angle, diameter distance, angle increment, and other parameters, and then click OK to jump to the reference arc stakeout interface, click Save/Measurement- Store to calculate the stakeout information, and expand the graphic interface on the right to display the current position, prism points, and the position relationship between the stakeout points.

"Misclosure ": see the parameters of the stakeout arc term.

"Start rounded comers": set to g, then the starting stakeout point is the position of the starting point in the reference arc offset clockwise by an angle g, and $0 < g < 360$.

"Offset": see the parameters of the stakeout point item.

"Angle increment": set to f, then the stakeout interface can switch the stakeout point in steps of Angle

increment f by the up point down point button, and $0 < f < 360$.

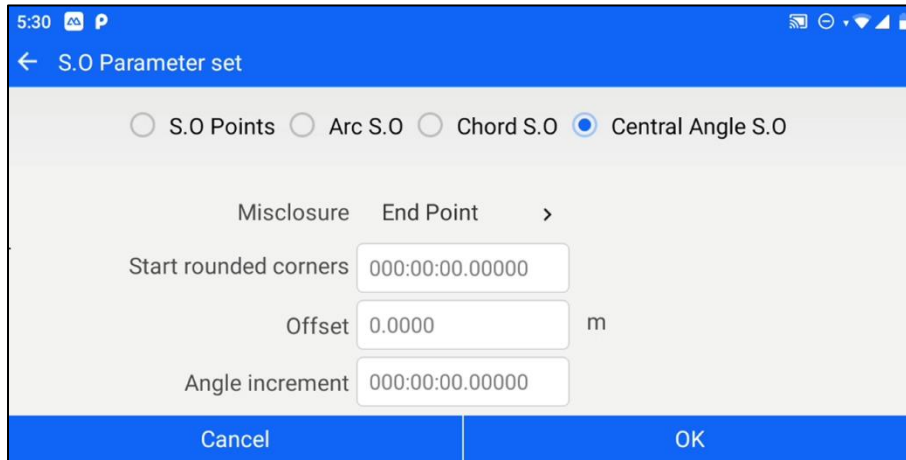

Figure 8-42

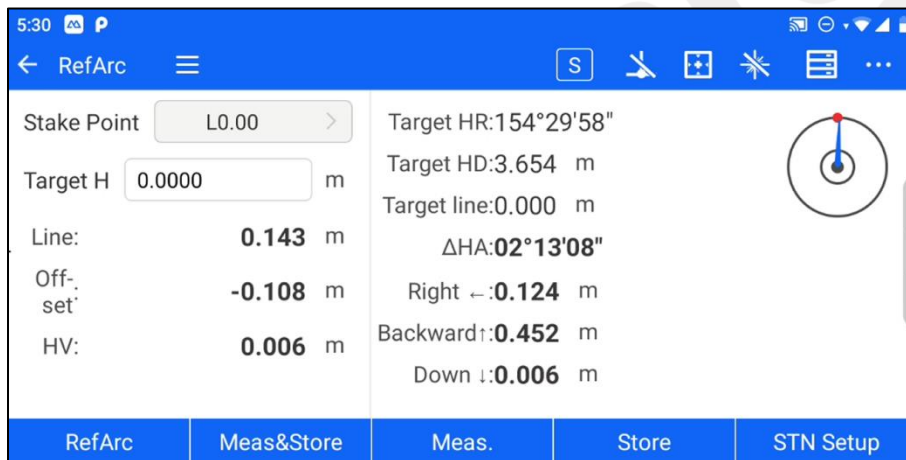

Figure 8-43

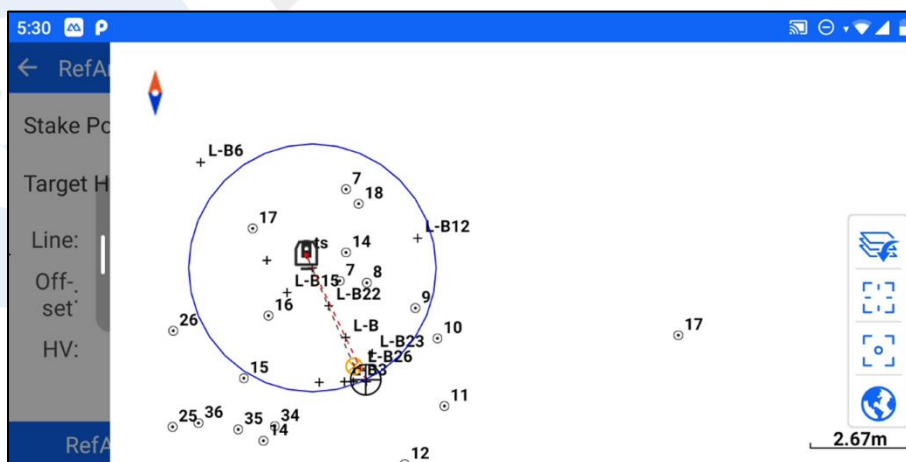

Figure 8-44

Chapter 9

COGO

This chapter contains:

- Without CP Correction
- Free Station Correction
- Calc.XYZ
- Inverse
- Area & Girth
- Angle Conversion
- Dist. Conversion
- Average
- Transition Curve
- Equidistant point
- Calculator

9.1 Without CP correction

The unknown point orientation correction function is used to post-process the data recorded from the unknown point orientation set-up measurements, i.e., to perform hindsight correction. The module can be accessed through [COGO] - [Without CP correction]. The operation steps are as follows.

1. Precondition: the station has been set up by unknown point orientation, the coordinates of several points are measured, and the correct coordinates of the hindsight point are known.
2. Enter [Without CP correction], which displays the list of unknown point orientation stations and the corresponding measurement points.

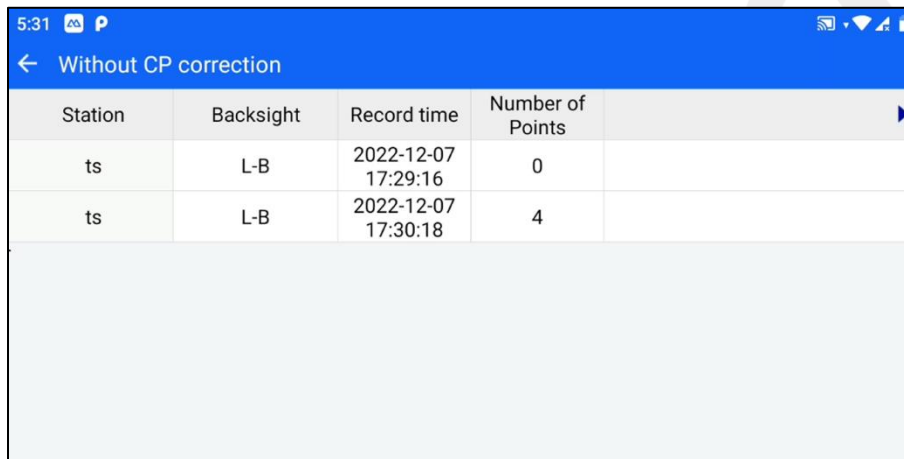

Station	Backsight	Record time	Number of Points
ts	L-B	2022-12-07 17:29:16	0
ts	L-B	2022-12-07 17:30:18	4

Figure 9-1

3. Click the parameter of the set-up station that needs to be calibrated to enter the list of corresponding measurement points.

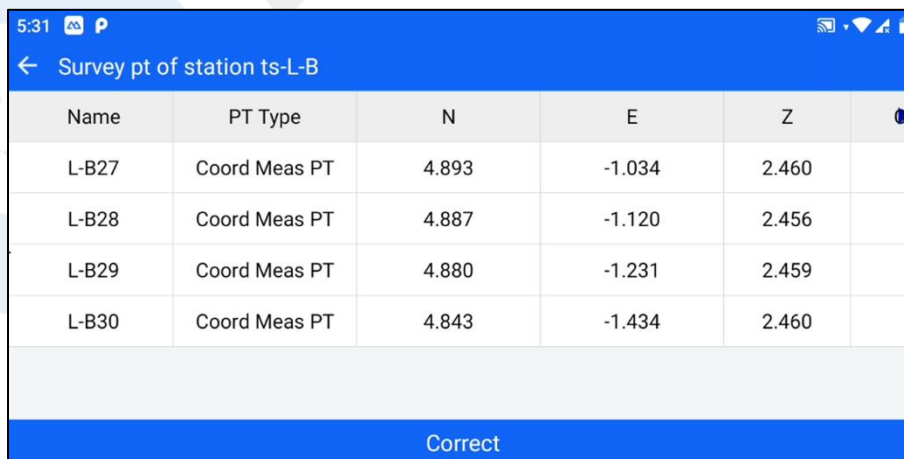

Name	PT Type	N	E	Z
L-B27	Coord Meas PT	4.893	-1.034	2.460
L-B28	Coord Meas PT	4.887	-1.120	2.456
L-B29	Coord Meas PT	4.880	-1.231	2.459
L-B30	Coord Meas PT	4.843	-1.434	2.460

Correct

Figure 9-2

4. Click [Correct], enter or list to select the hind viewpoint coordinates, click [OK], then complete the

unknown point orientation correction. The corresponding measurement coordinate points in the point data are corrected according to the selected hind viewpoint coordinates.

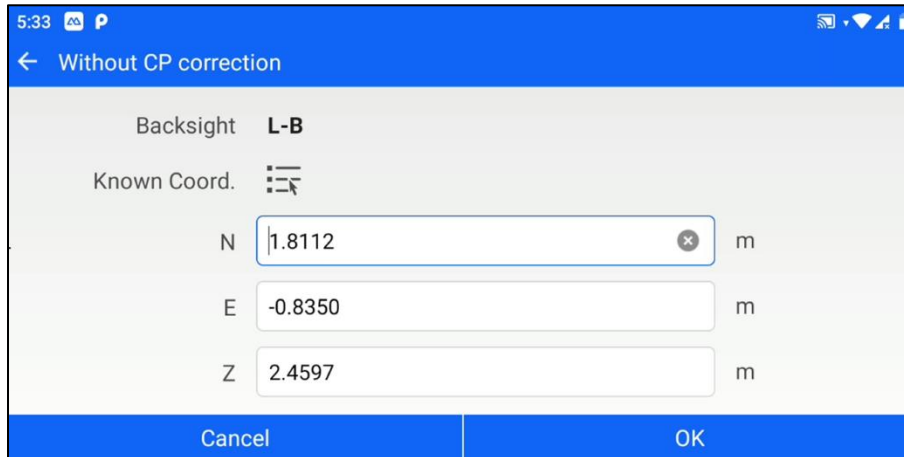

Coordinate	Value	Unit
N	1.8112	m
E	-0.8350	m
Z	2.4597	m

Figure 9-3

9.2 Free Station Calibration

The orientation-free correction function is used to post-process data recorded from orientation-free set-up measurements, i.e., to perform the hind-sight correction. It is divided into the known point method and the common point method. The module can be accessed through [COGO] - [Free Station Correction].

9.2.1 Known Point Method

The known point method is used for back-view correction when the correct coordinates of one of the measurement points are known. The operation steps are as follows.

1. Precondition: the station has been set up direction-free, the coordinates of several points have been measured, and the correct coordinates of one of the measurement points have been known.
2. Go to [Free Station Correction] and select the known point method. Click the list of selected points button after the station to select the station to be corrected.

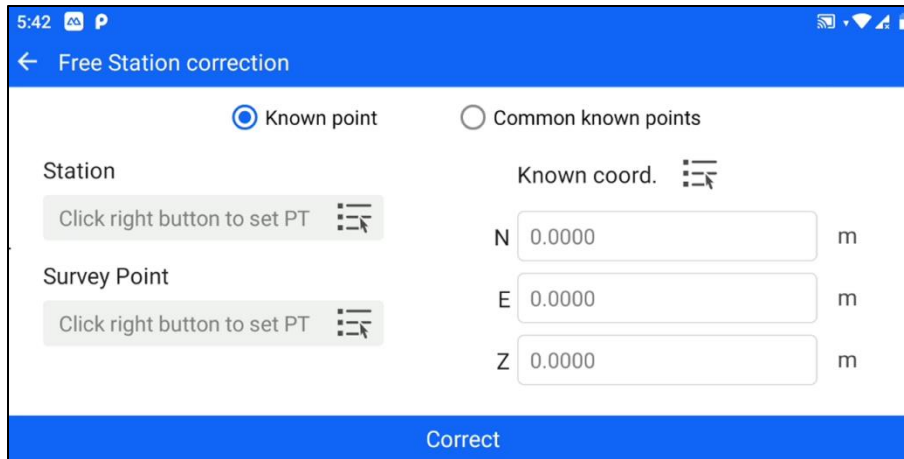
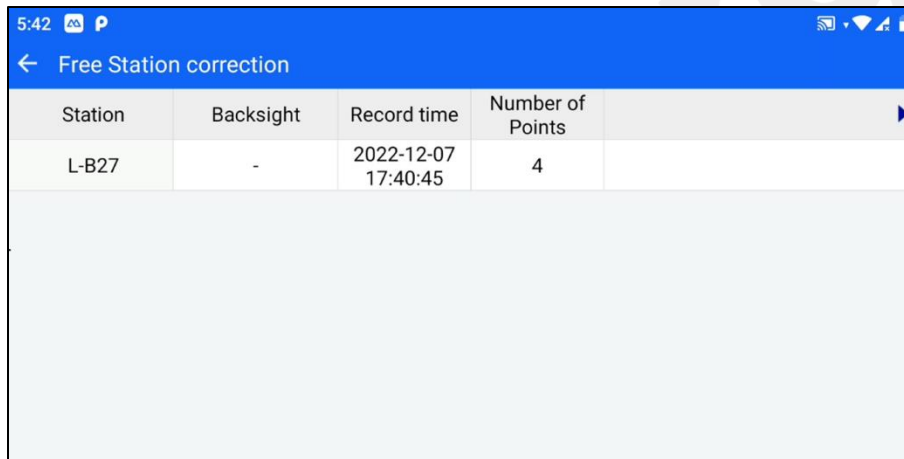

Figure 9-4



Station	Backsight	Record time	Number of Points
L-B27	-	2022-12-07 17:40:45	4

Figure 9-5

3. Click on the list selection button after the measurement point to select the measurement point for which you know the correct coordinates.

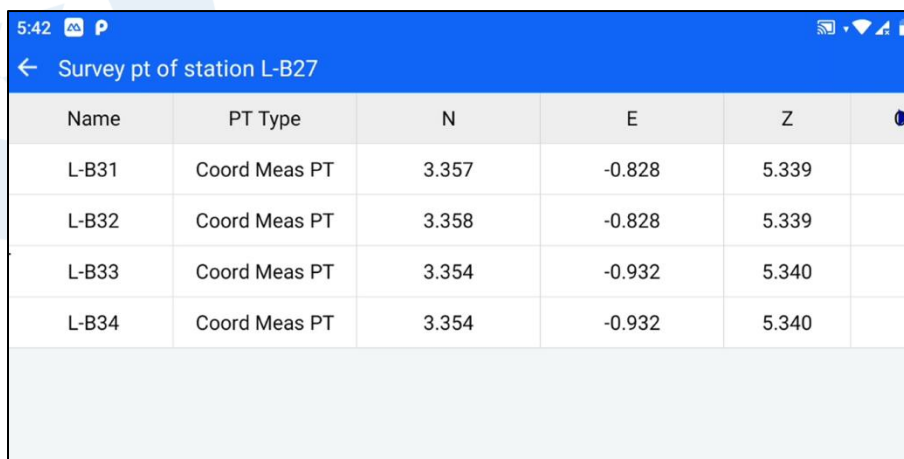

Name	PT Type	N	E	Z
L-B31	Coord Meas PT	3.357	-0.828	5.339
L-B32	Coord Meas PT	3.358	-0.828	5.339
L-B33	Coord Meas PT	3.354	-0.932	5.340
L-B34	Coord Meas PT	3.354	-0.932	5.340

Figure 9-6

4. Enter or list select the known coordinates corresponding to the measurement point at the known coordinates. Click [Correct].

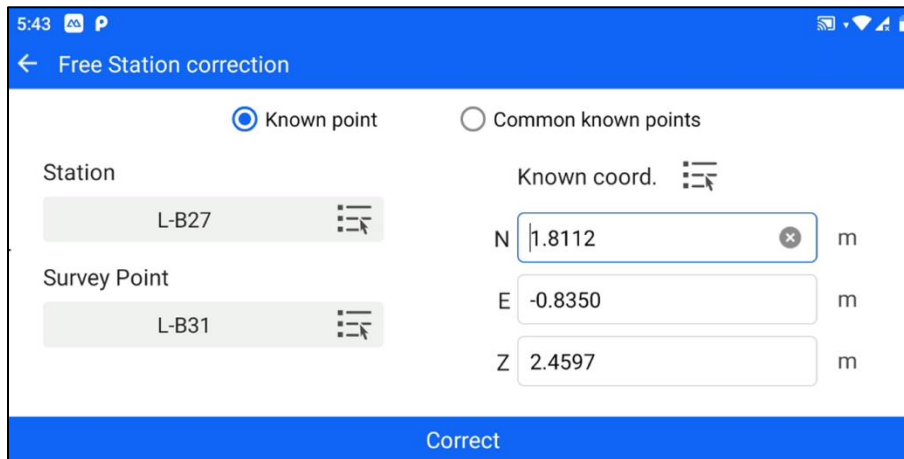
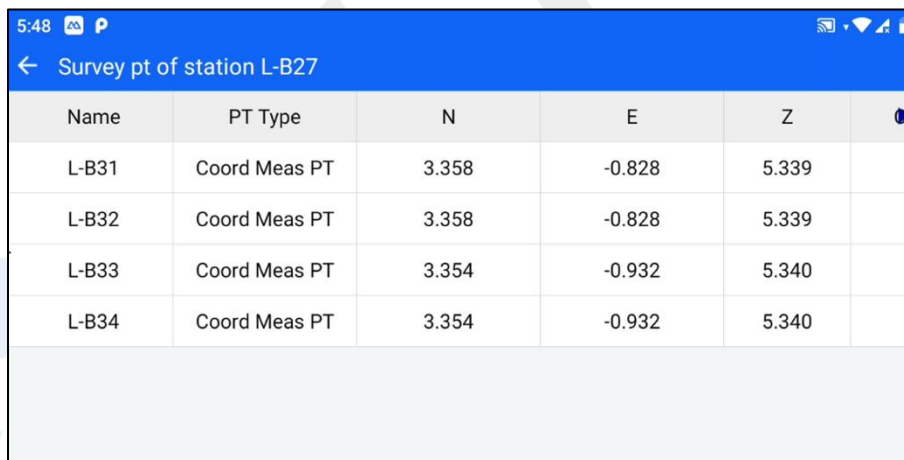

Figure 9-7

5. If the correction is successful, the corresponding measurement coordinates in the point data are modified to the corrected coordinates. Note that if the difference between the known point coordinates and the actual observed value is more than 10 cm, the correction will not be successful.



Name	PT Type	N	E	Z	
L-B31	Coord Meas PT	3.358	-0.828	5.339	
L-B32	Coord Meas PT	3.358	-0.828	5.339	
L-B33	Coord Meas PT	3.354	-0.932	5.340	
L-B34	Coord Meas PT	3.354	-0.932	5.340	

Figure 9-8

9.2.2 Common Point Method

The common point method is used for hindcast correction in the case where two different stations have been set up without orientation in the same coordinate system, and two different stations have observed the same prismatic point. The operation steps are as follows.

1. Pre-condition: there are two direction-free stations and corresponding measurement points, and one of the measurement points for the two stations set up public observation.
2. Go to [Free Station Correction] and select the Common Point Method. Select STA 1, Known coord 1,

STA 2, and Known coord 2, respectively.

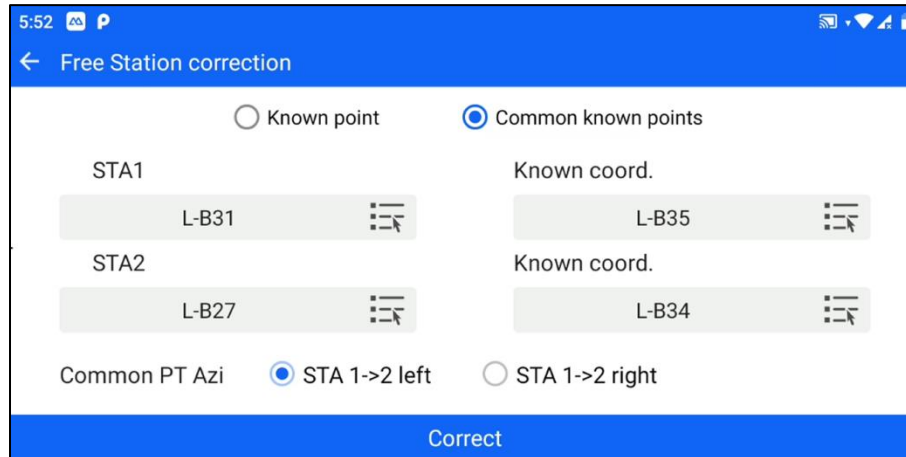
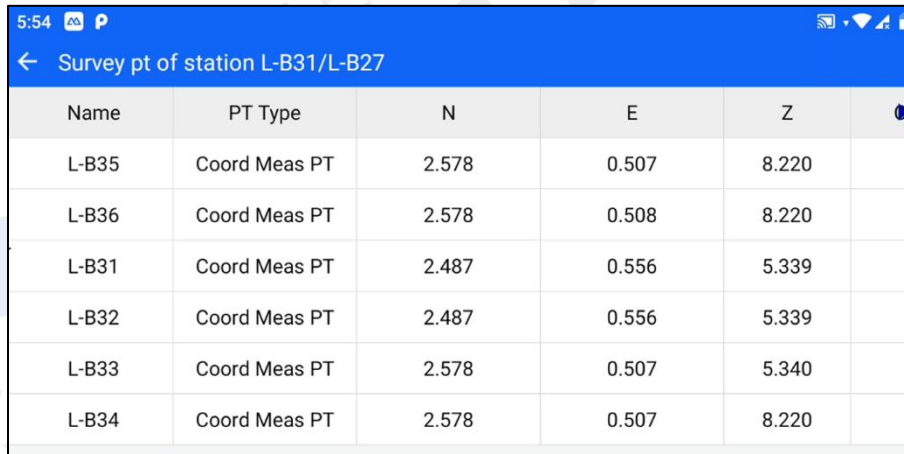

Figure 9-9

3. Select the orientation of the common point, if the common point is on the left side of the line from station 1 to station 2, that is, select "STA 1->2 left", and vice versa, select "STA 1->2 right".

4. After setting, click [Correct]. If the calibration is successful, the corresponding measurement coordinates of both stations in the point data are modified to the corrected coordinates.



Name	PT Type	N	E	Z
L-B35	Coord Meas PT	2.578	0.507	8.220
L-B36	Coord Meas PT	2.578	0.508	8.220
L-B31	Coord Meas PT	2.487	0.556	5.339
L-B32	Coord Meas PT	2.487	0.556	5.339
L-B33	Coord Meas PT	2.578	0.507	5.340
L-B34	Coord Meas PT	2.578	0.507	8.220

Figure 9-10

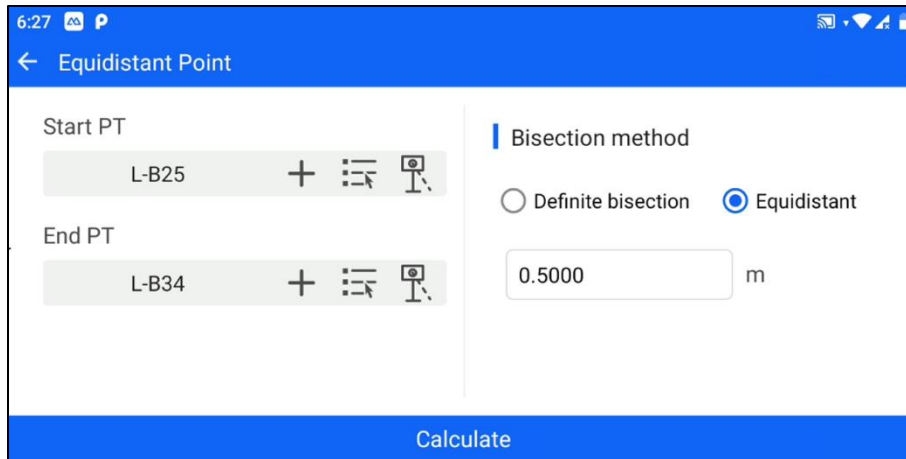

Figure 9-11

id	N	E	Z
0	3.004	-0.880	1.019
1	3.004	-0.879	1.024
2	3.004	-0.878	1.028
3	3.003	-0.877	1.033
4	3.003	-0.876	1.038
5	3.003	-0.875	1.043

Figure 9-12

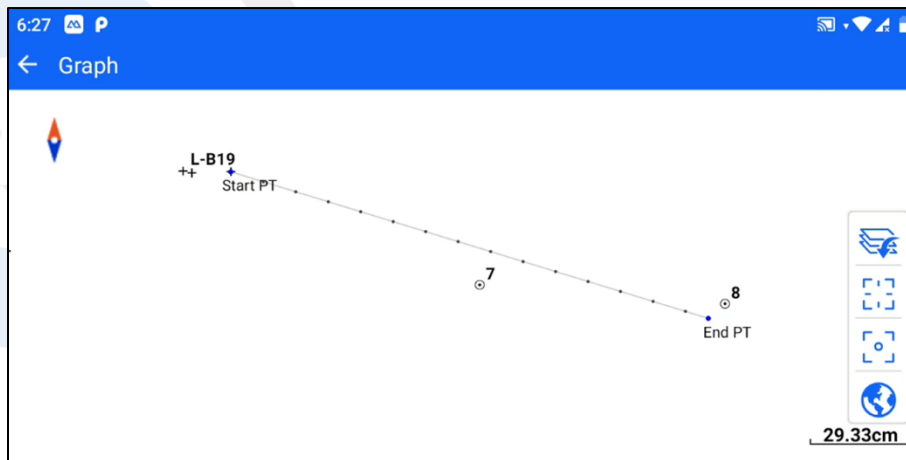

Figure 9-13

9.3 Calculator

Tool for performing simple mathematical calculations.

9.4 Calc. XYZ

The coordinate orthogonal calculation function can derive the specific coordinate information of the endpoint by setting the spatial relationship between the start point and the endpoint relative to the start point.

The starting point can be input and selected by manual input, list selection, measurement selection, etc. After selecting the starting point, set the starting azimuth, rotation angle, flat distance, and elevation difference information of the ending point relative to the starting point, click the "Calculate" button, and then display the calculation result of the coordinates of the ending point after projection.

Click on the "Graph" button to view the relationship between the start and end points of the plane.

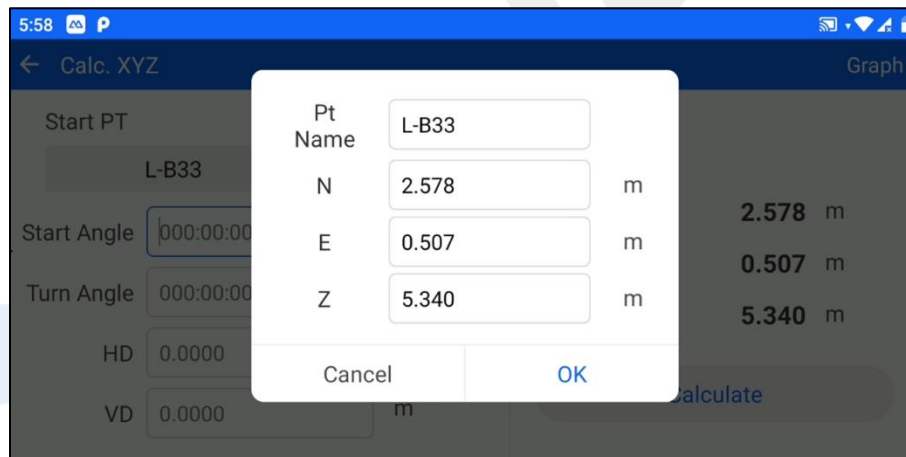

Figure 9-14

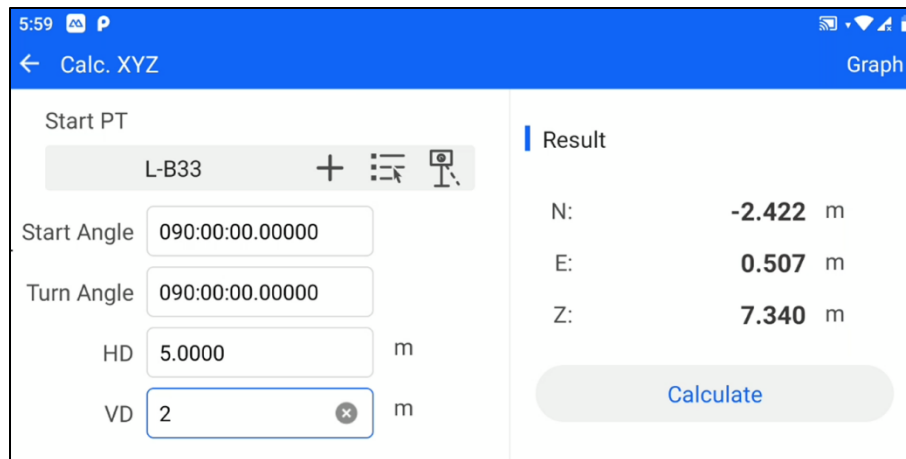

Figure 9-15

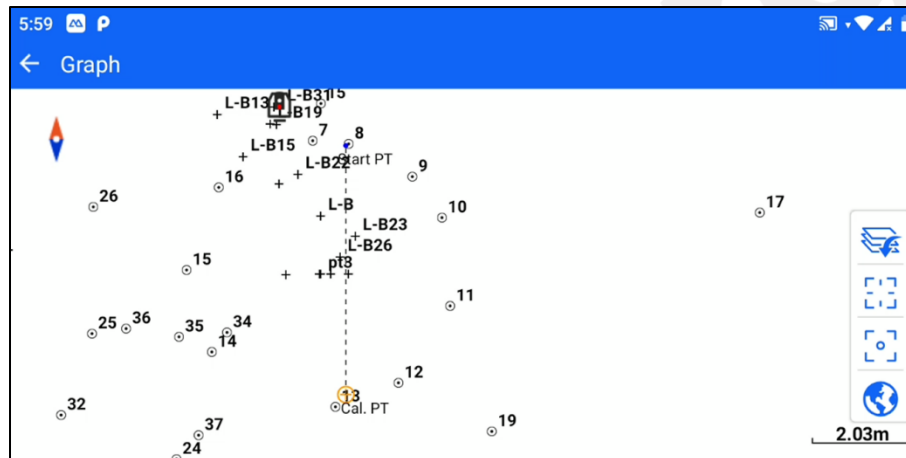

Figure 9-16

9.5 Inverse

The coordinate back-calculation function can derive the spatial information of the endpoint concerning the start point from the coordinate information of the start point and the endpoint.

The start point and end point can be input and selected by manual input, list selection, measurement selection, etc. After selecting the start point and end point, click the "Calculate" button, and the SD (spatial linear distance between the start point and the end point), HD (horizontal linear distance between the start point and the end point), VD (elevation difference between the start point and the end point), azimuth and slope information of the endpoint relative to the start point will be displayed after calculation. (horizontal distance between the start point and end point), VD (elevation difference between the start point and end point), azimuth, and slope information.

Click on the "Graph" button to view the relationship between the start and end points of the plane.

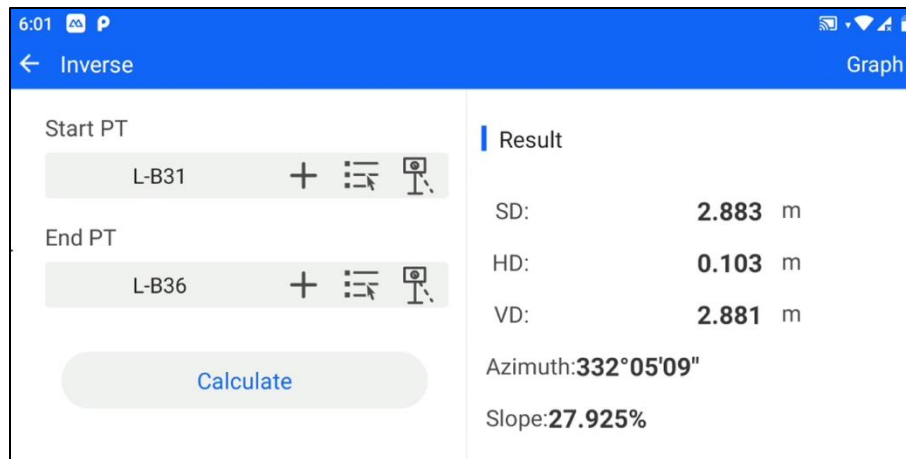

Figure 9-17

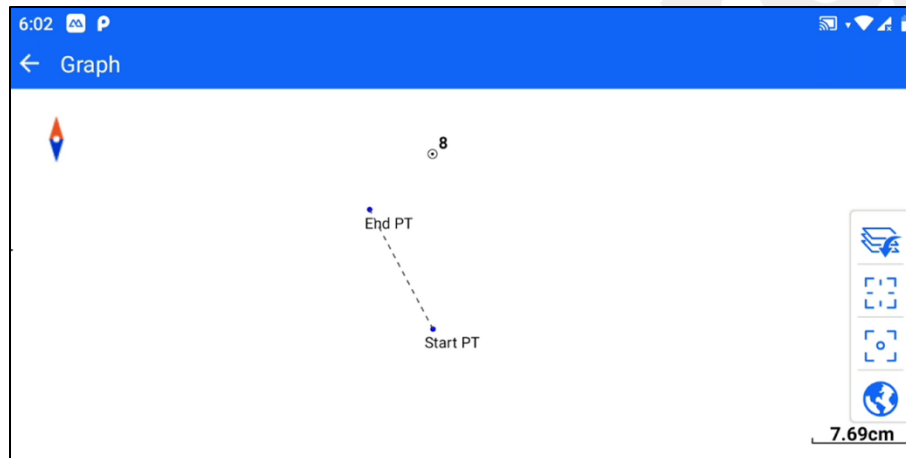

Figure 9-18

9.6 Area&Girth

Click to enter the area perimeter, you can select multiple point data to form the group of polygon vertices that need to calculate the area by manual input, list selection of points, measurement selection of points, etc.

After entering point data, click on any point data item to edit, delete, move up, move down, etc.

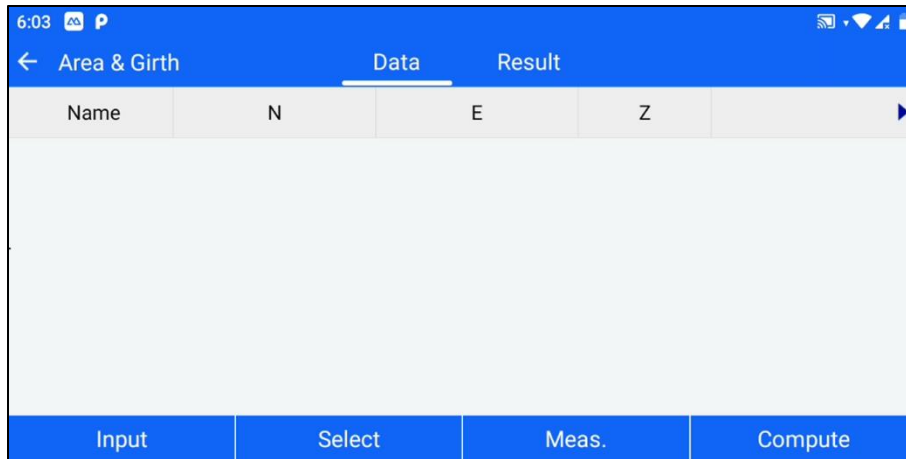

Figure 9-19



Figure 9-20

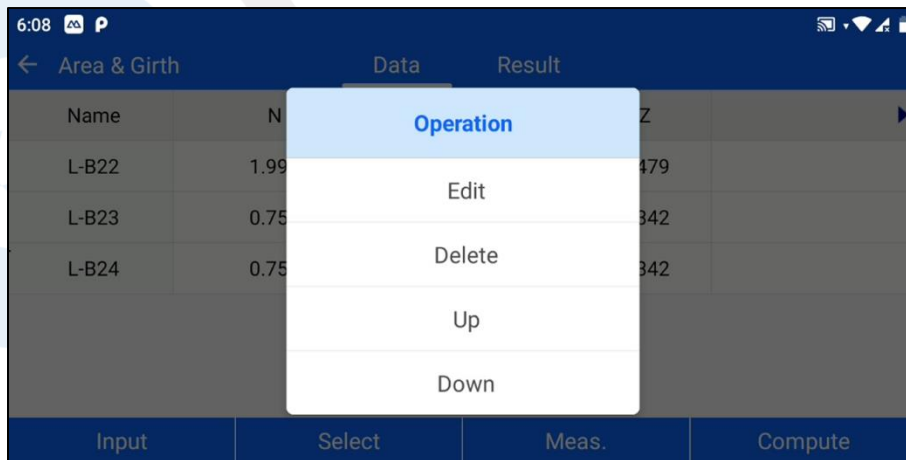

Figure 9-21

Click Calculate after you finish the selection, you can jump to the resulting interface to view the calculation results, including graphical results and area length data results.

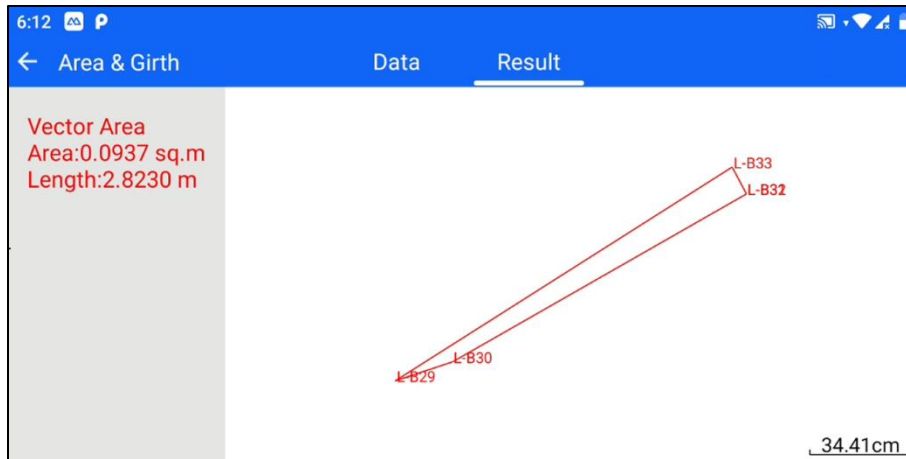

Figure 9-22

9.7 Angle Conversion

Supports the conversion of radians, degrees, gauges, minutes, mils, and degrees-minutes-seconds units to each other. After entering the value in any item, click [Compute] to calculate the value in other formats.

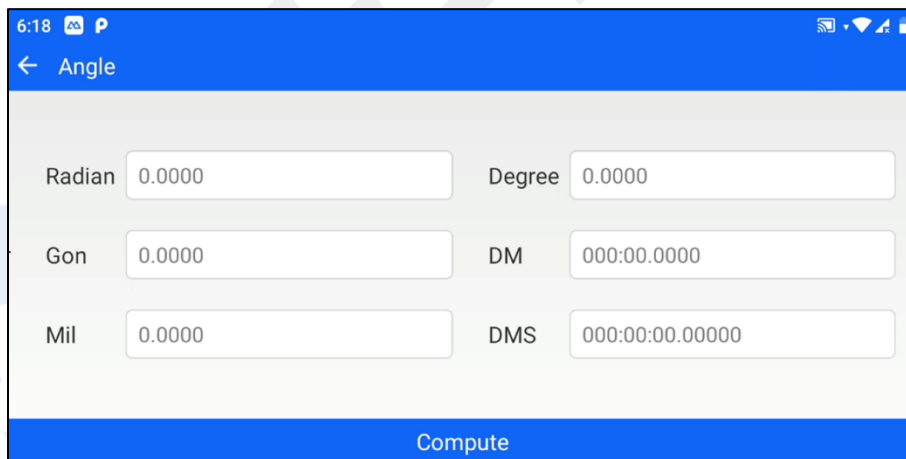

Figure 9-23

9.8 Dist. Conversion

Support converting each distance unit of kilometer, meter, centimeter, millimeter, yard, mile, foot, inch, and nautical mile to each other. After entering the value in any item, click [Compute] to calculate the value in other formats.

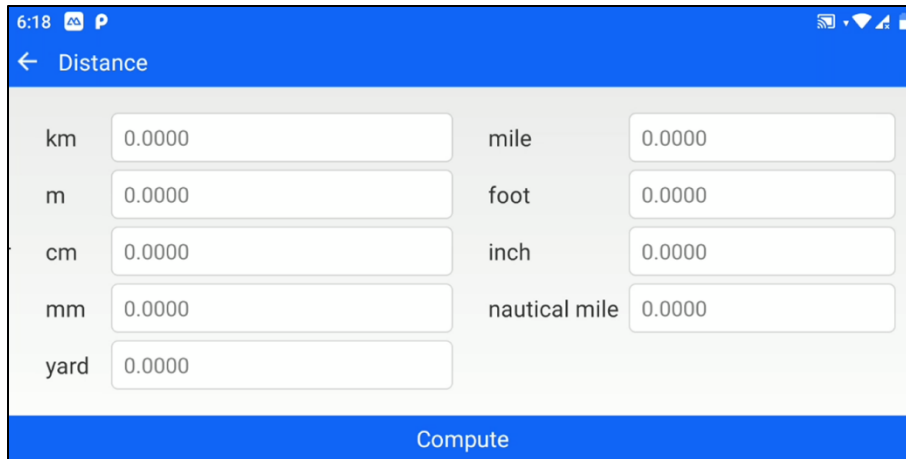

Figure 9-24

9.9 Average

Users can click [COGO] - [Average] to enter this interface and calculate the average of several points coordinates by this function. Click the Add button to add the points to be calculated to the list below, then the average value of the coordinates of the selected points will be displayed at the top in real-time.



Average PT	N:	m	σ :	m
	E:	m	σ :	m
	Z:	m	σ :	m

Name	N	E	Z
+			

Figure 9-25



Figure 9-26



Name	N	E	Z
L-B29	1.851	-0.642	2.459
L-B32	2.487	0.556	5.339
L-B33	2.578	0.508	5.3

Figure 9-27

9.10 Transition curve

Users can click [COGO] - [Transition curve] to enter this interface and calculate the gentle curve parameters, starting half-longitude and ending radius by this function.

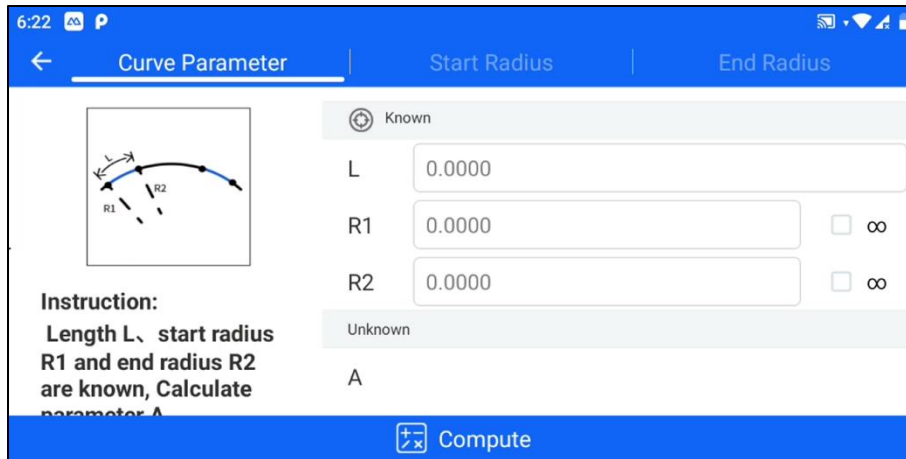

Figure 9-28

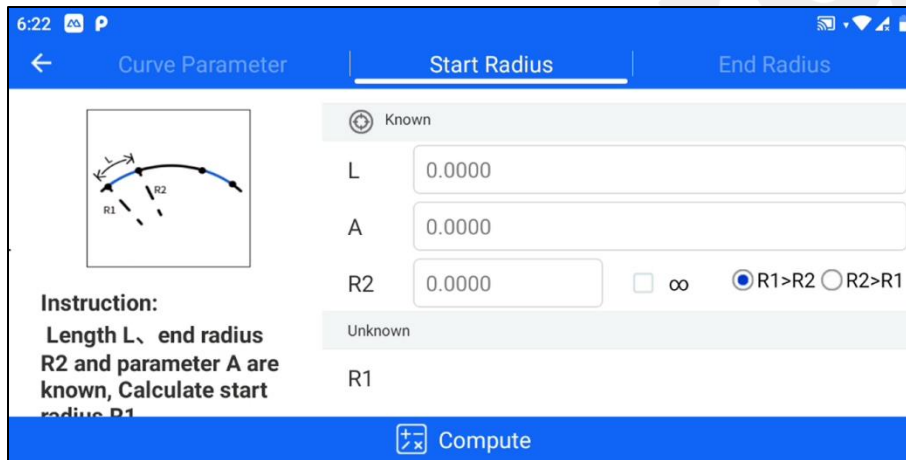

Figure 9-29

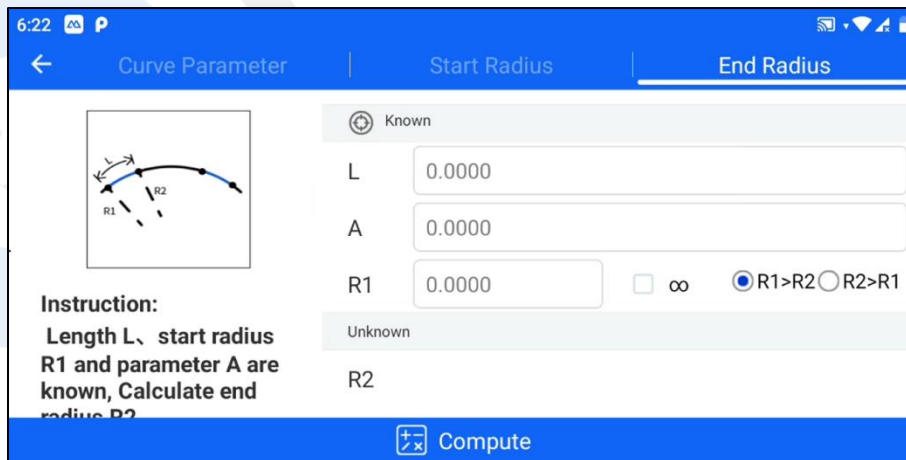

Figure 9-30

9.11 Equidistant Point

The line segments are divided into equal parts according to two types of equal parts: constant number equal parts and constant distance equal parts.

You need to input the coordinates of the start point and end point, there are three input methods, which are manual input, list selection, and measurement selection. Then select the equipartition method, input the parameters, and click [Compute] to get the equipartition result. Click [Graph] to get the graph of the line segment after equipartition; click Save to save the equipartition points to the library of stakeout points.



Chapter 10

Project

This chapter contains:

- Project
- Point Library
- Ground Code



Hi-Target

10.1 Project

Enter the project interface, you can view the current project properties, Ground codes, and other information, open, delete, or view the history of projects, create new projects, and other operations.

[Open Project]: Click the project you need to open, and click "Open" to open the selected project.

[Delete Item]: Click on the item to be deleted and click "Delete" to delete the selected item.

[View Properties]: The current item can be viewed by clicking the "View info" button on the first line; the history item can be viewed by clicking the item that needs to be viewed and clicking "Properties" to view the properties of the selected item.

[Ground Code]: Click the "Ground Code" button in the title bar to jump to view the current project's Ground code content.

[New Project]: Click the "+" button to enter the new project interface, enter the name (required), operator, comments, etc., select the Ground code, click OK to complete the new project, and open.

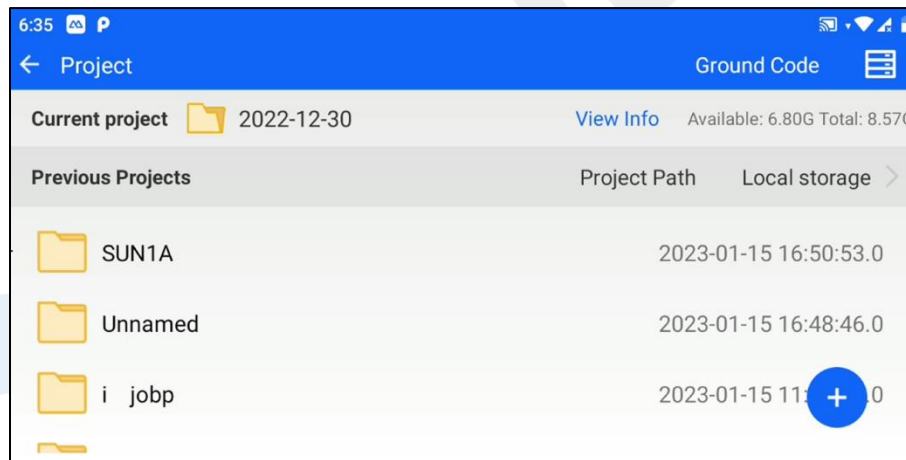

Figure 10-1

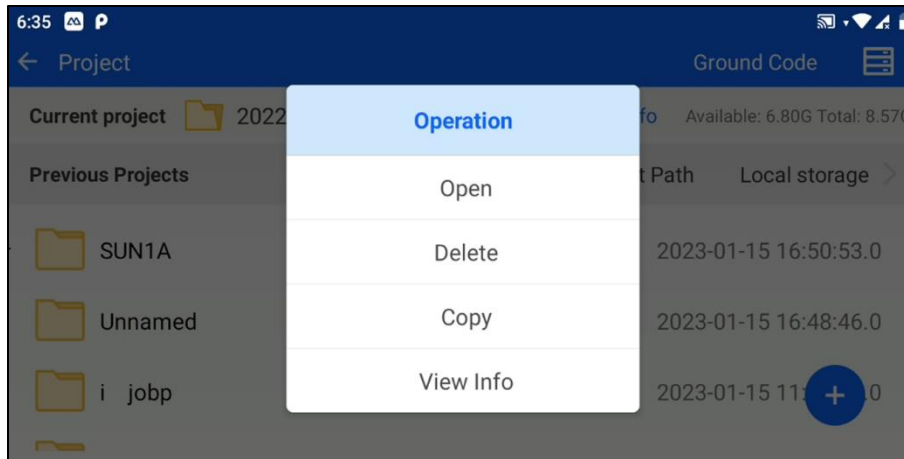

Figure 10-2

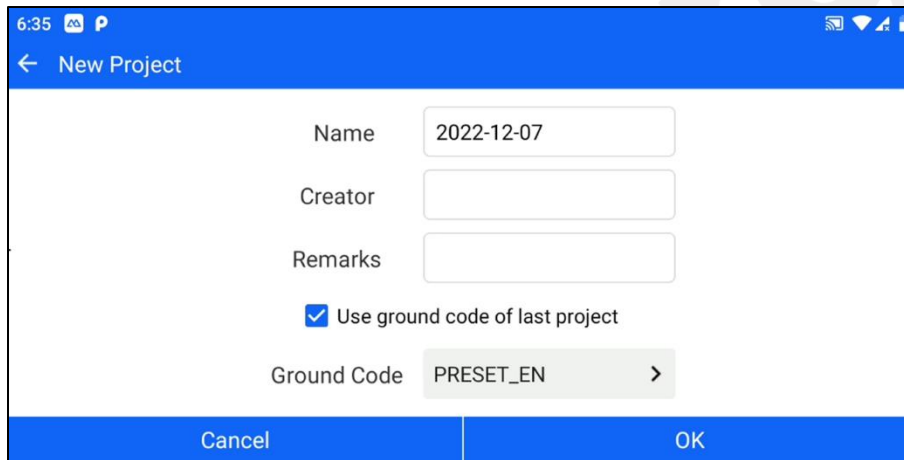



Figure 10-3

If the current total station has been inserted into an external USB flash drive, you can also copy the items in the USB flash drive to local storage, view the properties, and delete them.

Locally stored items can also be copied to a USB flash drive.

10.2 Point Library

The point library can be accessed from the main screen or the top bar of any measurement screen at  the icon.

Point blank generic functions.

1. Click [Graph] in the upper right corner to view the display of each type of point on the map.

Pt Name	N	E	Z	Code	Description
s1	2542817.290	435198.099	7.918	station	station
gg3	2542818.831	435196.735	9.160	backsight-By Known PT	backsight-By Known PT
s1	2542817.290	435198.099	7.918	station	station
pt3	2542820.886	435198.099	9.560	backsight-By Known PT	backsight-By Known PT
pt3	-	-	-	Resection	Resection

Figure 10-4

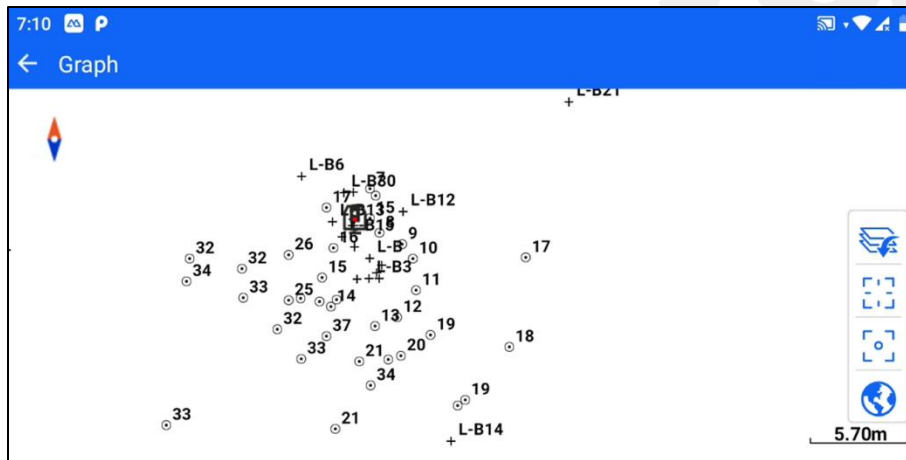

Figure 10-5

2. Click "..."/>

Pt Name	N	E	Z	Code	Description
s1	2542817.290	435198.099	7.918	station	station
gg3	2542818.831	435196.735	9.160	backsight-By Known PT	backsight-By Known PT
s1	2542817.290	435198.099	7.918	station	station
pt3	2542820.886	435198.099	9.560	backsight-By Known PT	backsight-By Known PT
pt3	-	-	-	Resection	Resection

Figure 10-6

3. Click "..."-[Settings] in the upper right corner to set the loading order and the number of loading.
4. Click a point library data, you can choose to "edit" or "delete" the data. If there is a point record of the measurement points, you can also view the point record.

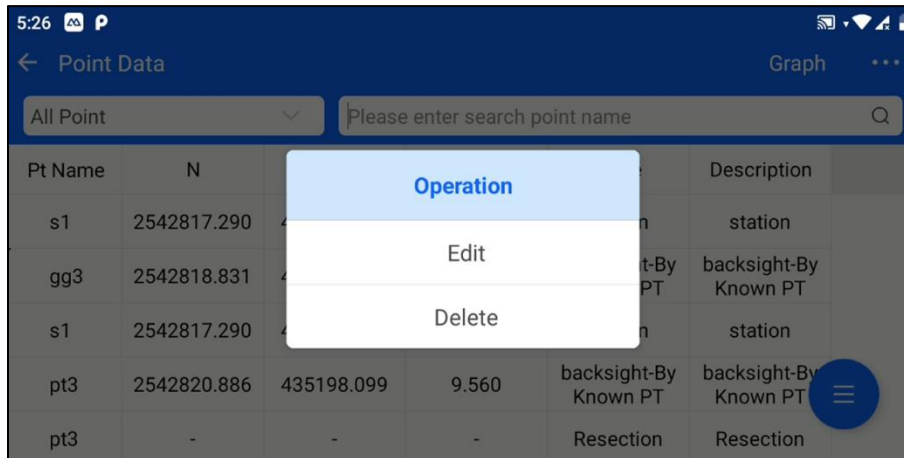

Figure 10-7

5. Enter a full or partial name in the name input box, and click "Search" to search for a point.

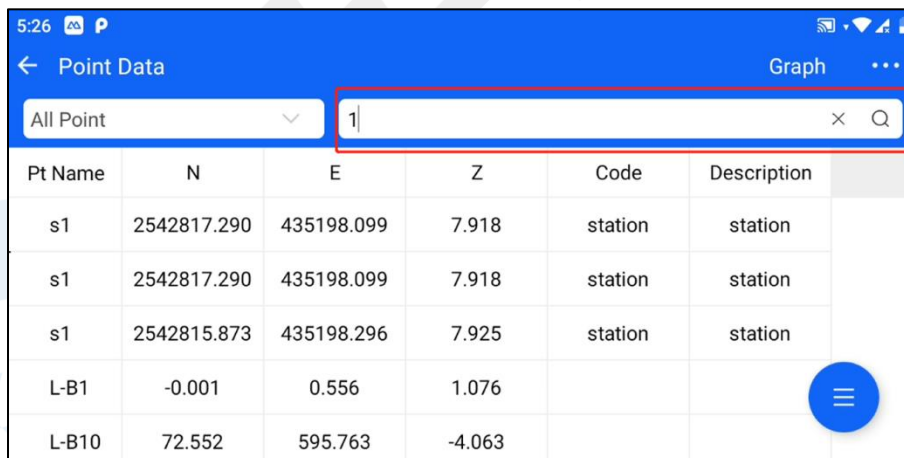
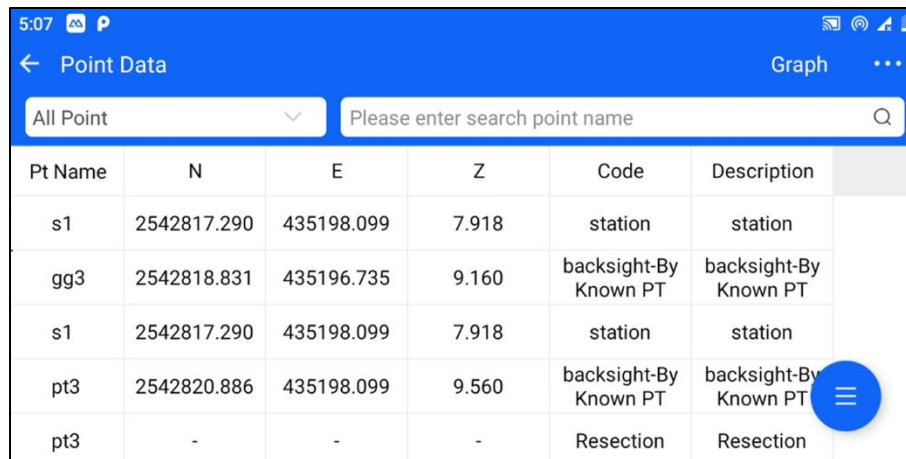

Figure 10-8

10.2.1 All Points

When the point library is switched to select all points, the interface displays the NEZ and Ground code information of all points (measurement points, stakeout points, control points).



Pt Name	N	E	Z	Code	Description
s1	2542817.290	435198.099	7.918	station	station
gg3	2542818.831	435196.735	9.160	backsight-By Known PT	backsight-By Known PT
s1	2542817.290	435198.099	7.918	station	station
pt3	2542820.886	435198.099	9.560	backsight-By Known PT	backsight-By Known PT
pt3	-	-	-	Resection	Resection

Figure 10-9

Click the hover button at the bottom right corner - "Import", you can import the sample/control points. Select the type of points you want to import (stakeout points/control points) in the top bar, and then select the file to import. The detailed import operation is shown in the section "Stakeout Point".

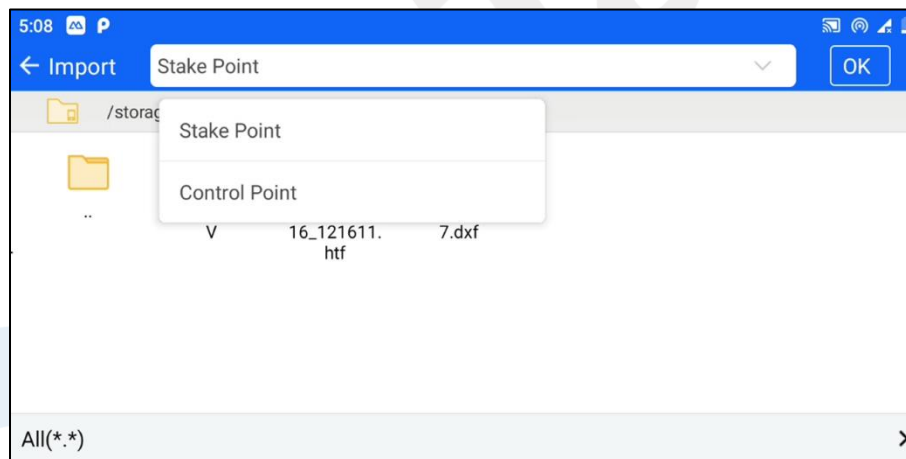

Figure 10-10

Click the "Export" hover button at the bottom right corner to export the measurement points/plotting points/control points. Select the type of points to be exported (measurement points/stakeout points/control points) in the top bar, and then select the export format. The specific export operation steps and supported formats can be found in the [Measurement Points], [stakeout Point], and [Control Points] sections.

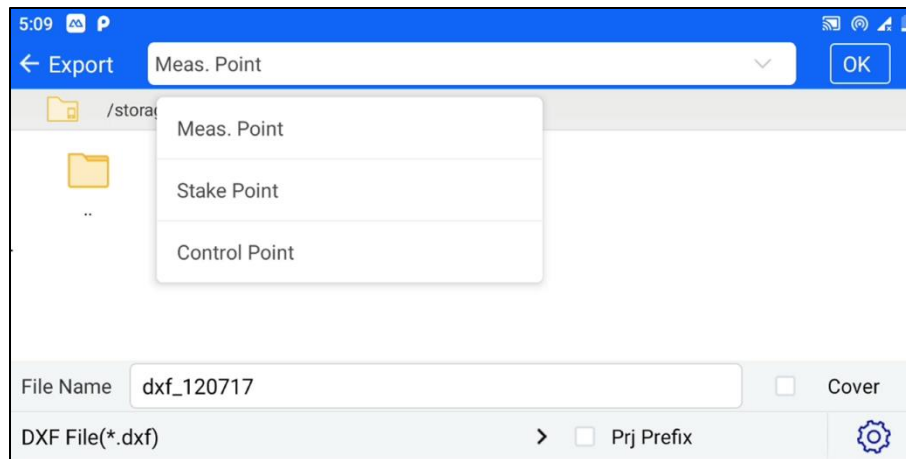
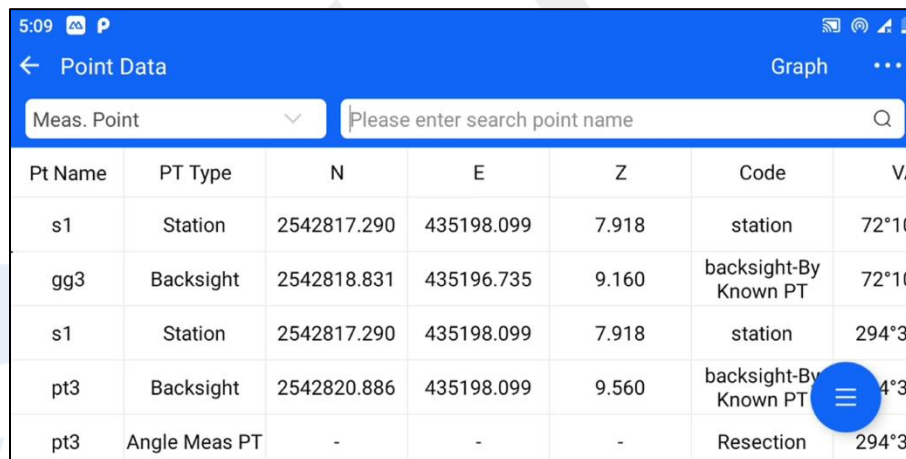

Figure 10-11

10.2.2 Measurement Points

When the point bank selects measurement points, the information of all measurement points (including measurement points, Backsight points, angle measurement points, distance measurement points and coordinate measurement points) is displayed.



Pt Name	PT Type	N	E	Z	Code	VA
s1	Station	2542817.290	435198.099	7.918	station	72°10'
gg3	Backsight	2542818.831	435196.735	9.160	backsight-By Known PT	72°10'
s1	Station	2542817.290	435198.099	7.918	station	294°31'
pt3	Backsight	2542820.886	435198.099	9.560	backsight-By Known PT	4°31'
pt3	Angle Meas PT	-	-	-	Resection	294°31'

Figure 10-12

Click on the hover button at the bottom right corner - "Export" to export the measurement points. Select the desired export format, enter the file name, and click "OK" to export the measurement points to the total station memory. Currently, the supported export formats are *. htf, *.txt, *.csv, *. dat, *. GSI, *. dxf and *. gt7.

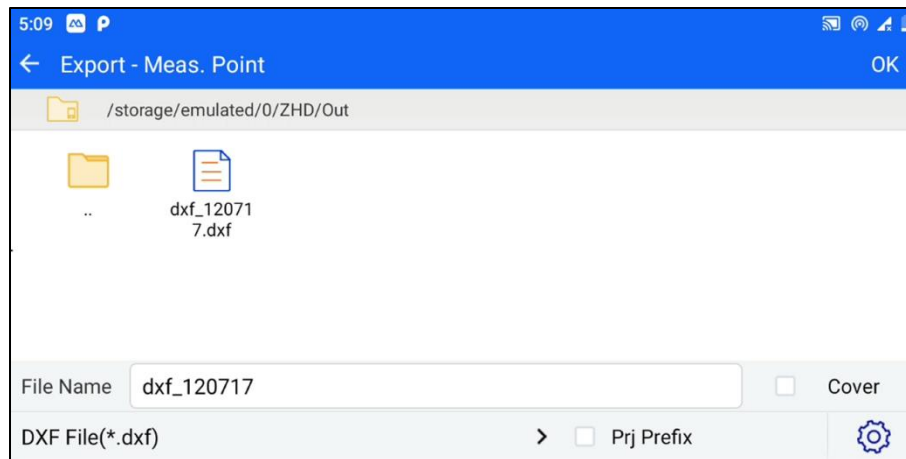

Figure 10-13

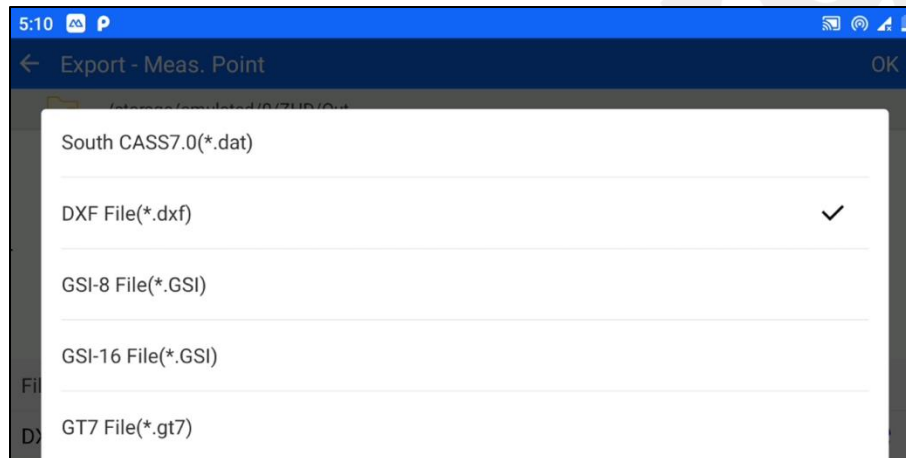
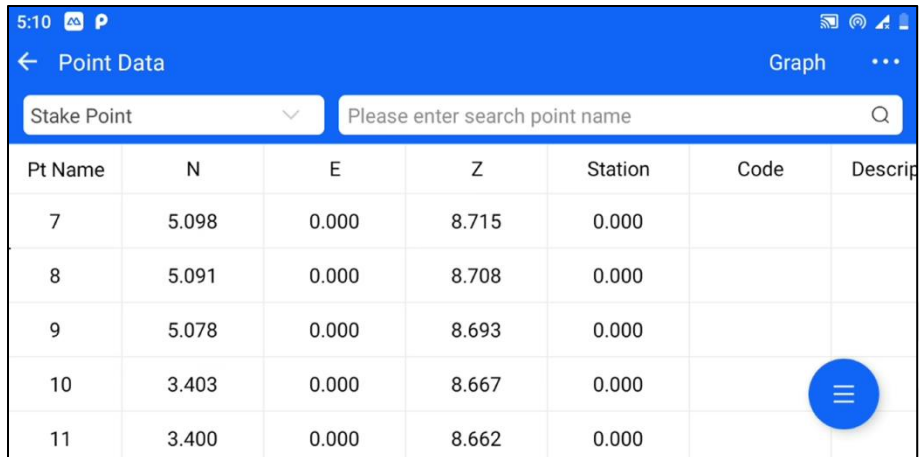

Figure 10-14

10.2.3 Stakeout Point

The sample points support the "Add", "Import" and "Export" functions, and the entrance is the hover button at the bottom right corner.



Pt Name	N	E	Z	Station	Code	Descrip
7	5.098	0.000	8.715	0.000		
8	5.091	0.000	8.708	0.000		
9	5.078	0.000	8.693	0.000		
10	3.403	0.000	8.667	0.000		
11	3.400	0.000	8.662	0.000		

Figure 10-15

[Add]: Click the hover button-[Add] to enter the interface of adding stakeout points. You can select points in the list or manually input them to add sample points.



5:11 Add Stake Point

Pt Name: N: m

Code: E: m

Station: m Z: m

Cancel OK

Figure 10-16

[Import]:

1. Click the hover button - [Import] to enter the sample point import interface. Select a file and click "OK."

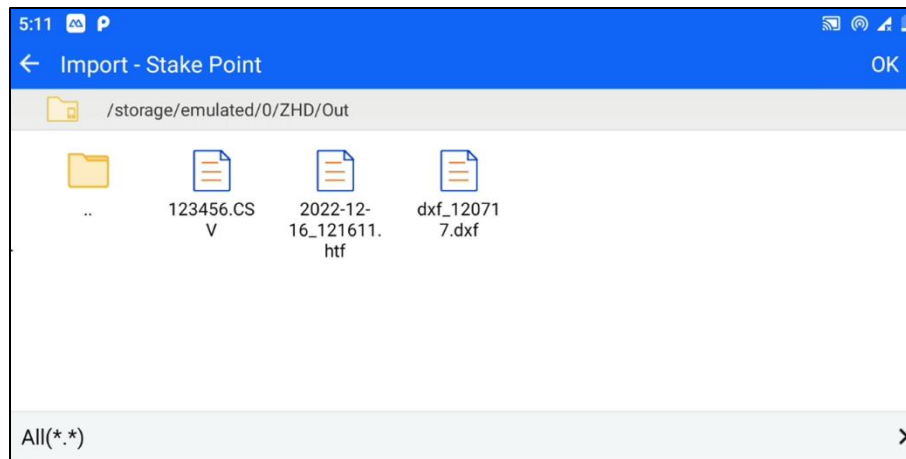



Figure 10-17

2. Enter the custom format setting interface, make the following settings, and click "OK" to complete the data import.

① Select the fields to be imported in the "Selectable Fields" list, the selected fields will be automatically populated in the "Selected Fields" list, click the  button to select/unselect all fields. The "Imported Content" section displays the header section of the imported fields in order.

② Click the "Template" button to display three common templates by default (Name, Ground code, NEZ; Name, NEZ, Ground code; Name, NEZ).

③ You can set the angle format, separator, and whether to include the format file header, etc.

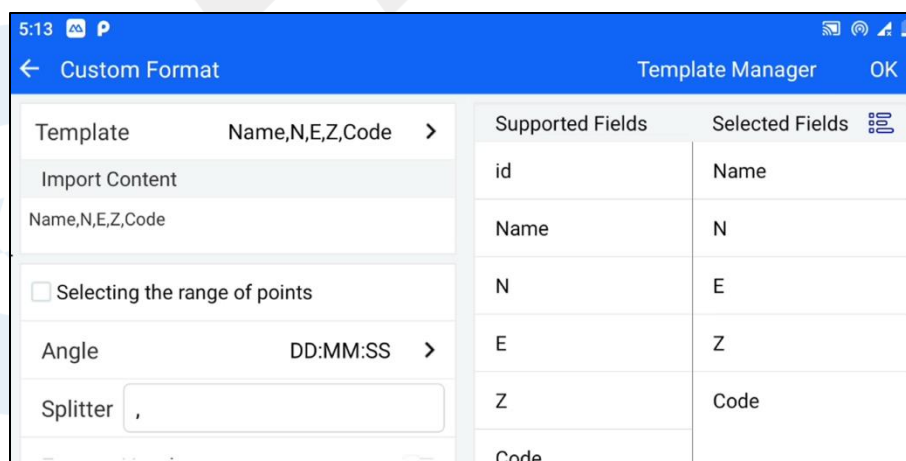
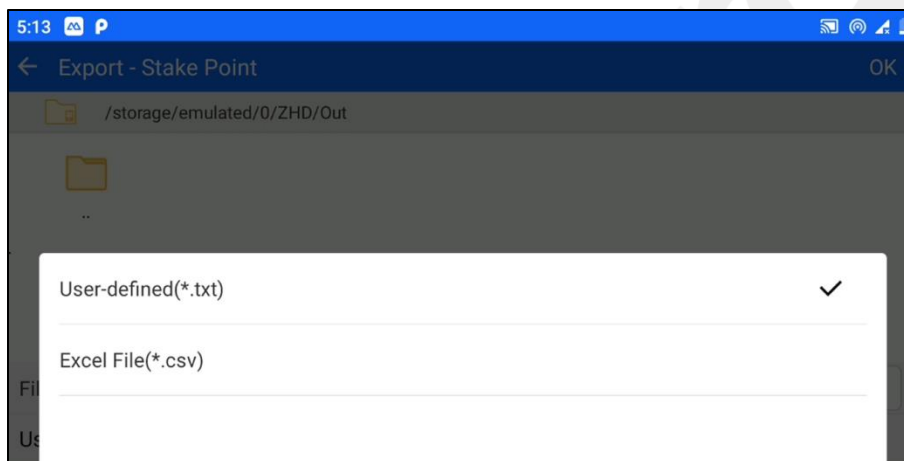
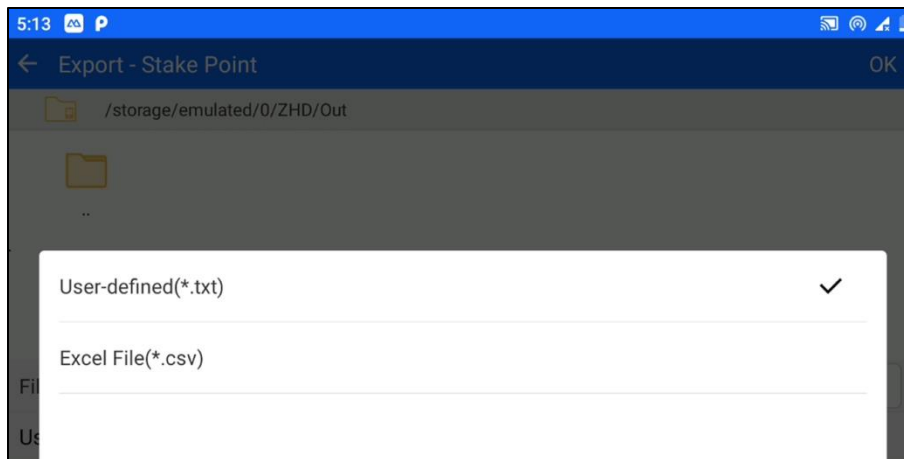

Figure 10-18

[Export]:

1. Click the hover button-[Export] to enter the export interface of stakeout points. The available export formats are custom txt. and Excel files (csv).



10.2.4 Control Points

Control points also support "Add", "Import" and "Export" functions, the function entrance and operation steps are the same as [Stakeout Point], so we will not repeat them here.

10.3 Ground Code

The Ground code can be accessed from the top bar of the project management interface.

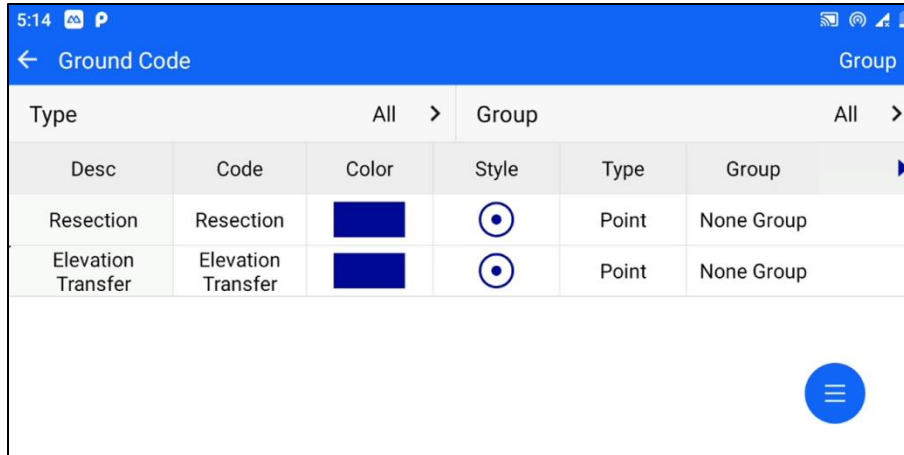





Type		All >	Group		All >
Desc	Code	Color	Style	Type	Group
Resection	Resection			Point	None Group
Elevation Transfer	Elevation Transfer			Point	None Group

Figure 10-19

"Type selection": click the type drop-down box, the available legend types are "all", "point", "line" and "Surface". After selecting the type, the Ground code of that type is displayed below.

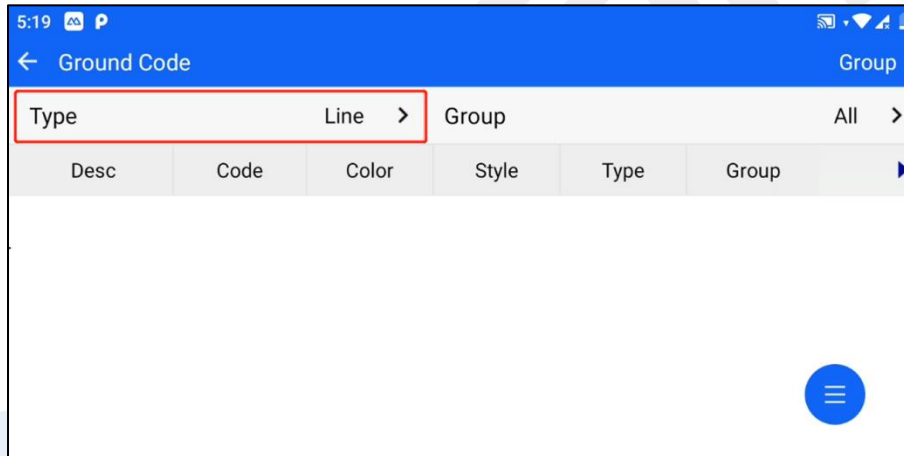

Type		Line >	Group		All >
Desc	Code	Color	Style	Type	Group

Figure 10-20

"Group Selection": Click the group drop-down box to display all groups under the current type. After selecting a group, the corresponding Ground code for that type is displayed below.

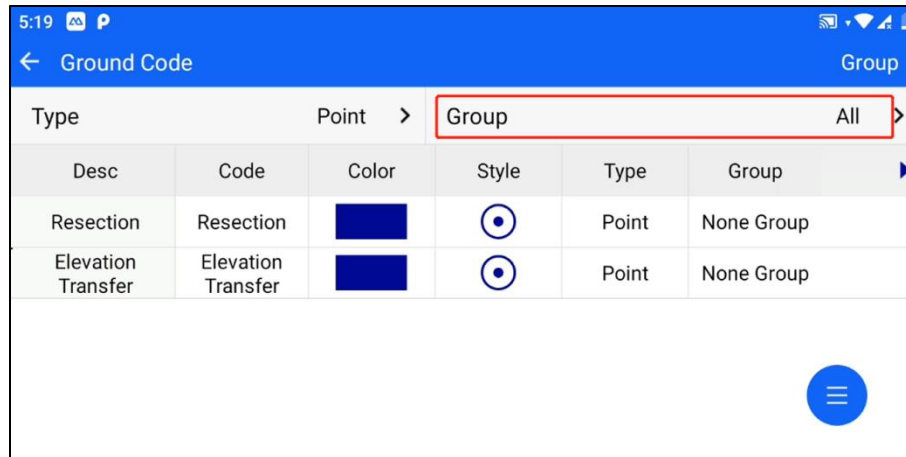

Figure 10-21

"Group editing": click "Group" in the upper right corner to enter group editing. You can "add", "delete", "edit" and other operations to the group. No group can be deleted or edited.

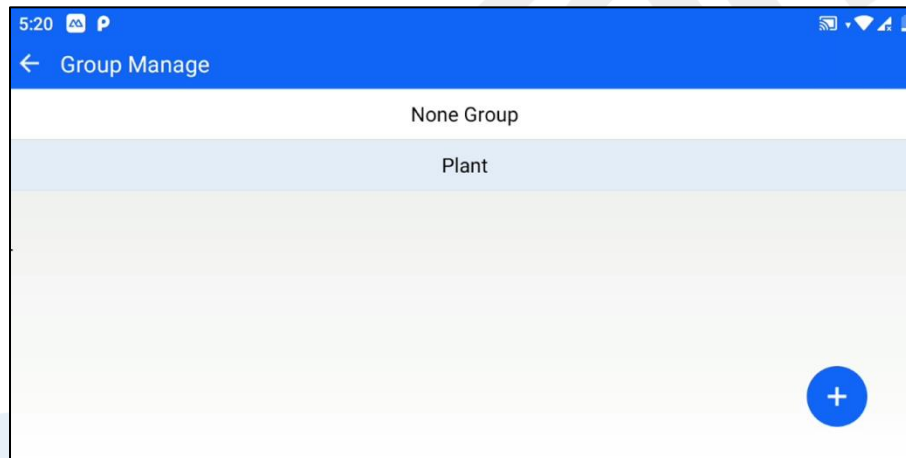

Figure 10-22

[Add]: Click the Add Hover button at the bottom right corner and enter the group name.

[Delete] / [Edit]: Click a group data, that is, the pop-up entrance.

"Ground code editing": click a Ground code data, click [Edit], and you can edit the Ground code, grouping, and style.

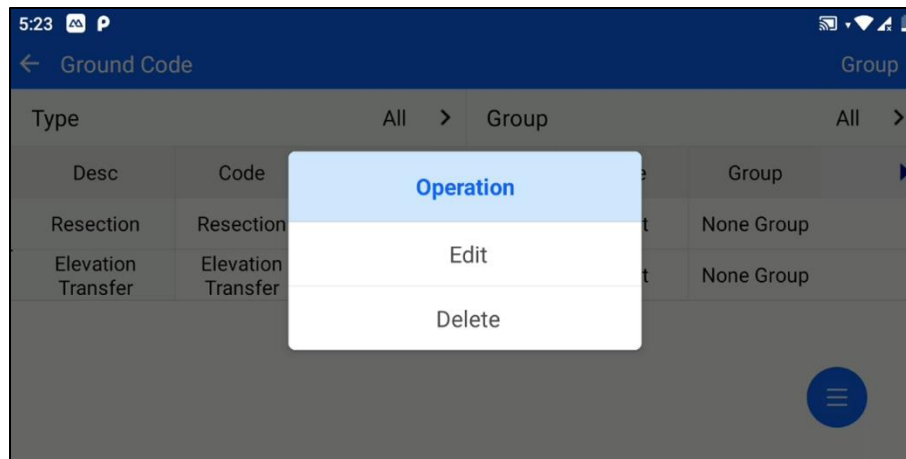

Figure 10-23

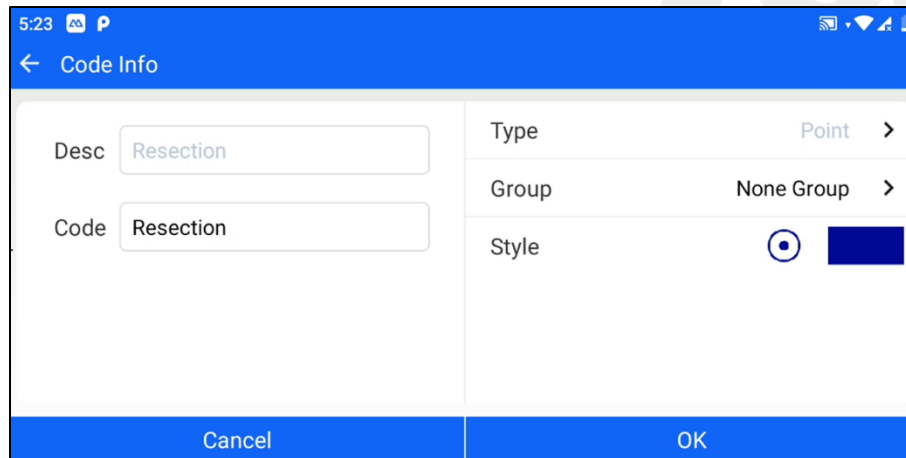

Figure 10-24

"Ground code deletion": click a Ground code data and click [Delete] to delete the code.

"Add Ground code": click the hover button at the bottom right corner - "Add" to enter the add interface, you can add the Ground code.

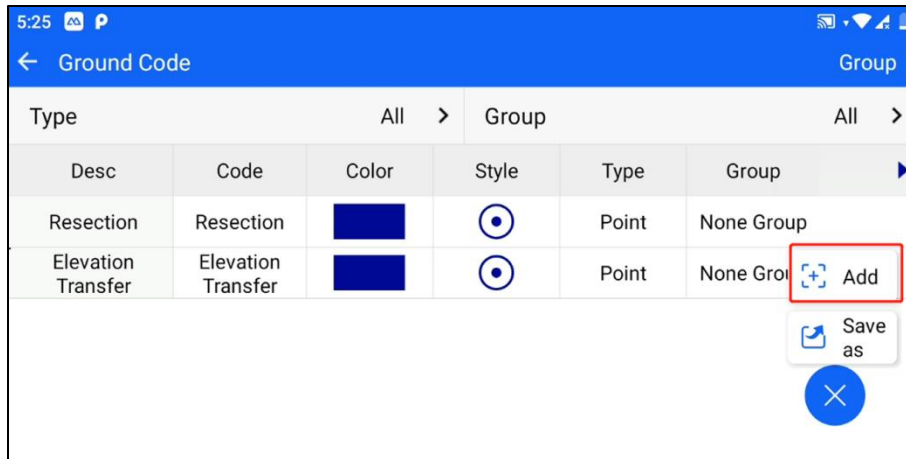

Figure 10-25

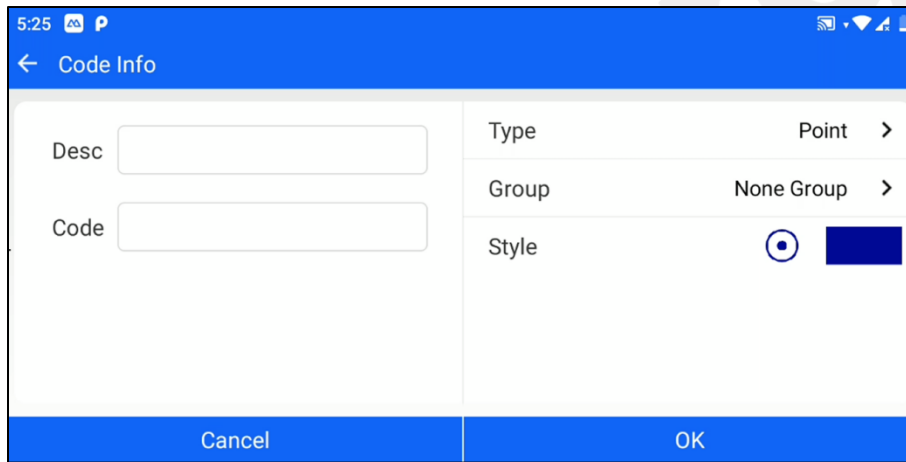

Figure 10-26

"Save as Template": Click the hover button at the bottom right corner - "Save ", you can save the current project Ground code as a Ground code template in XML format.

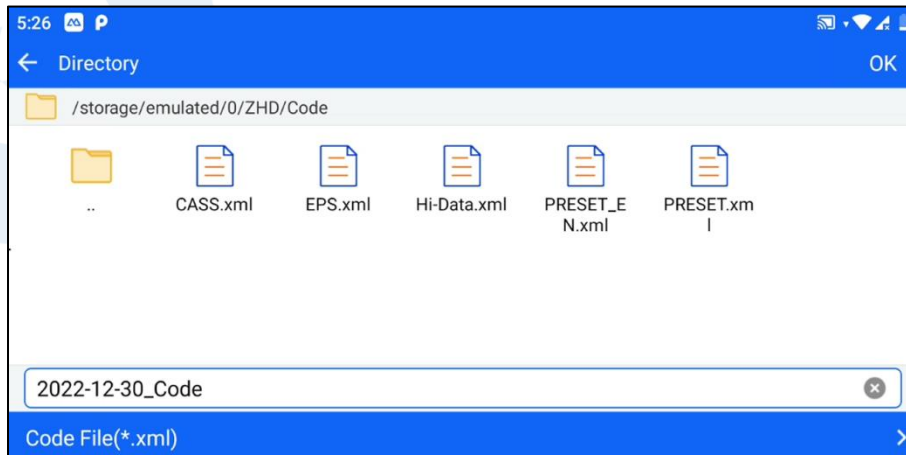

Figure 10-27

Chapter 11

Road

This chapter contains:

- Road Design
- Calculation
- Stake Road
- Structure S.O



Hi-Target

11.1 Road Design

Click Road -> Road Design to enter the road library interface, you can add road data by manually creating or importing road files, and also edit, delete, and export the existing roads.



Road Name	Broken Chainage	RoadAlign-ment	RoadProfile	RoadTransect	Construction	Start Bt
1	x	x	x	x	x	0.00

Figure 11-1

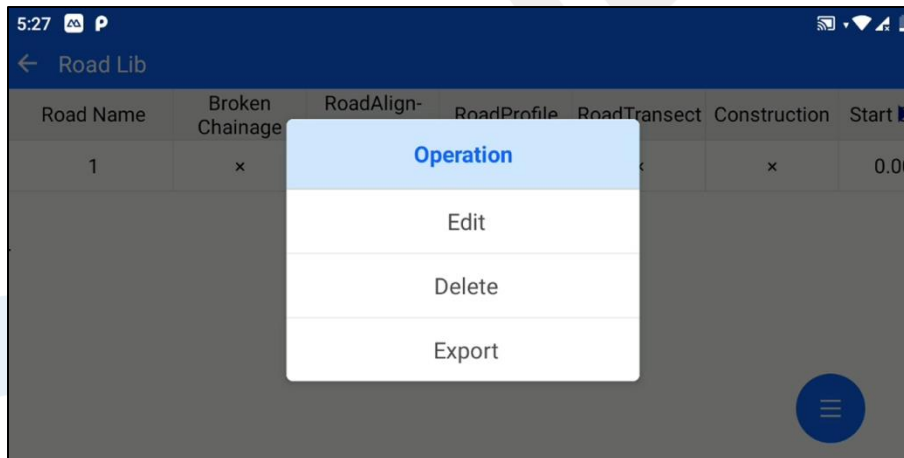

Road Name	Broken Chainage	RoadAlign-ment	RoadProfile	RoadTransect	Construction	Start Bt
1	x	x	x	x	x	0.00

Operation

- Edit
- Delete
- Export

Figure 11-2

11.1.1 Broken Chainage

A broken chain refers to the phenomenon of discontinuity of stakes due to local rerouting or sectional measurement. Overlapping stakes are called long chains and interrupted stakes are called short chains.

Click [Broken Link] to enter the broken link pile interface, you can add a broken link pile, and click a broken link pile to delete or edit the pile.

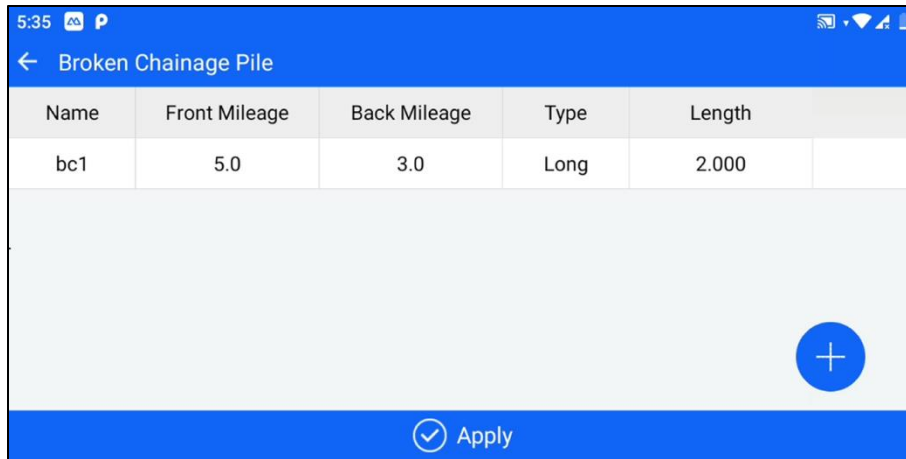

Figure 11-3

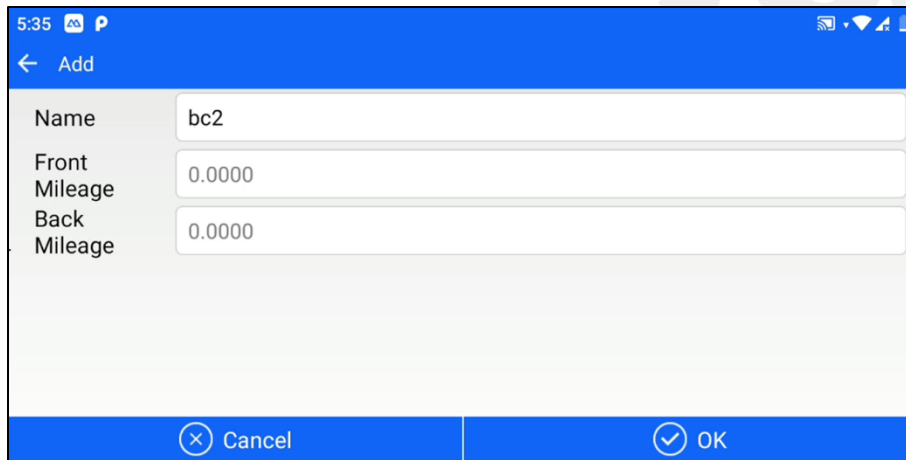

Figure 11-4

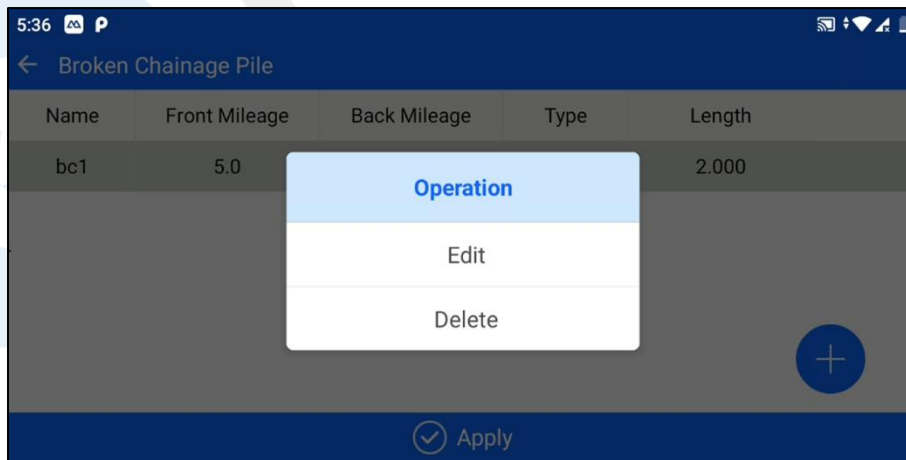

Figure 11-5

[Add]: Click the "+" button to enter the broken link adding interface. Edit the file name, enter the previous mileage and the next mileage, click "OK", and the completed broken link pile can be viewed under the

broken link pile list.

[Edit]: Click a broken link pile and select the "Edit" button to modify the pile name, previous mileage, and next mileage of the pile, click "OK" to finish the modification.

[Delete]: Click a broken pile, select the "Delete" button, and click "OK" to delete the selected broken pile.

[Apply]: After finishing adding and modifying the broken link pile, click the "Apply" button, it will return to the "Road Design" interface and prompt "broken link data has been updated".

11.1.2 Flat Section Design Line

The flat section design supports the use of the intersection method and the line element method. The intersection method is based on certain conventions (e.g. single intersection line defines the combination of line elements within the intersection as gently-rounded-curved-gently), and has certain expression restrictions on the line shape; while using the line element method, the line shape can be arbitrarily combined, and for complex curves, such as ovoid lines, multi-intersection curves, virtual intersections, and other data, the line element method is available to define the line, and the line element method defines the line to support the folded line.

Intersection method

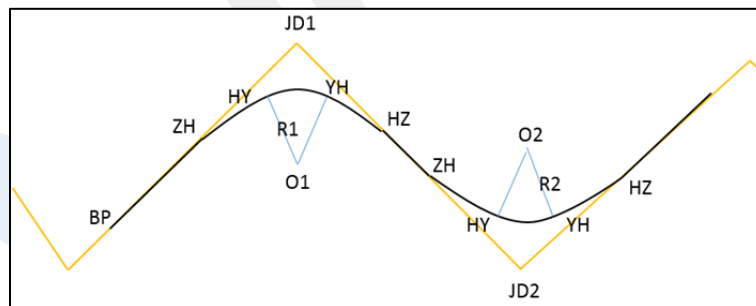

Figure 11-6

Intersection: The intersection of two adjacent lines (JD1, JD2...)

ZH: the point where the line intersects the first easing curve, i.e. the starting point of the first easing curve.

HY: the point where the first easing curve intersects the circular curve, i.e. the end of the first easing curve.

YH: the point where the circular curve intersects the second easing curve, i.e. the starting point of the second easing curve.

HZ: the point where the second easing curve intersects the straight line, i.e. the end of the second easing curve.

ZH-HY: first easing curve; YH-HZ: second easing curve.

HZ-ZH: straight line; HY-YH: circular curve.

Select [Intersection Method] to enter the intersection table data editing interface.





Name	Station	N	E	Radius	L of p
s1	-0.0576	2542817.2902	435198.0987	5.0000	0.00
gg3	2.0000	2542818.8307	435196.7347	5.0000	0.00
pt3	3.0000	2542820.8860	435198.0987	5.0000	0.00

Figure 11-7

[Add]: Click the "+" button to add the intersection data, get the intersection name, N, E, intersection mileage (only the mileage of the first two points need to be entered), and arc radius, the first easing curve length, the second easing curve length from the straight curve table, if the radius and curve length is corresponding to the intersection point, then enter it; if not, then do not enter it.

[Graph]: The data under the current intersection method list is automatically formed into a graph preview to see if the graph is correct.

"Line Auxiliary Points": Click the icon on the right side  to display the corresponding auxiliary points and auxiliary dashed lines in the preview map, and click the icon again  to make the auxiliary points disappear.

[Apply]: After the intersection method has been edited, click "Apply" to update the latest data.

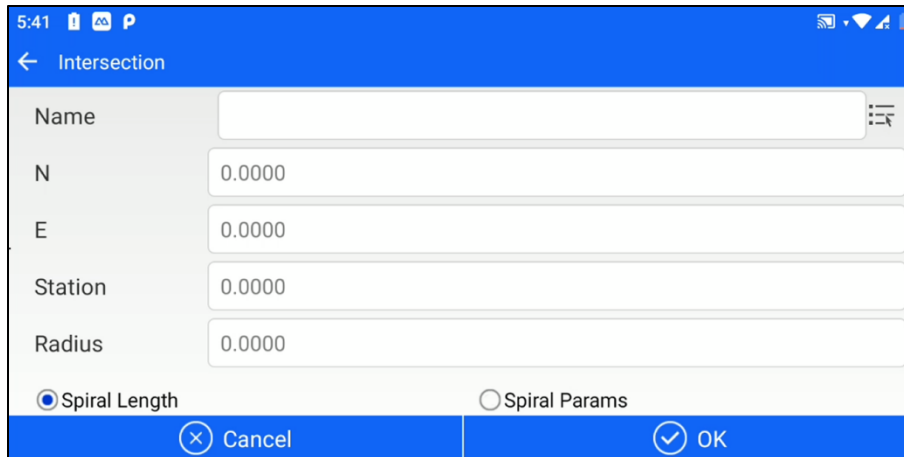

5:41

← Intersection

Name

N 0.0000

E 0.0000

Station 0.0000

Radius 0.0000

Spiral Length Spiral Params

Cancel OK

Figure 11-8

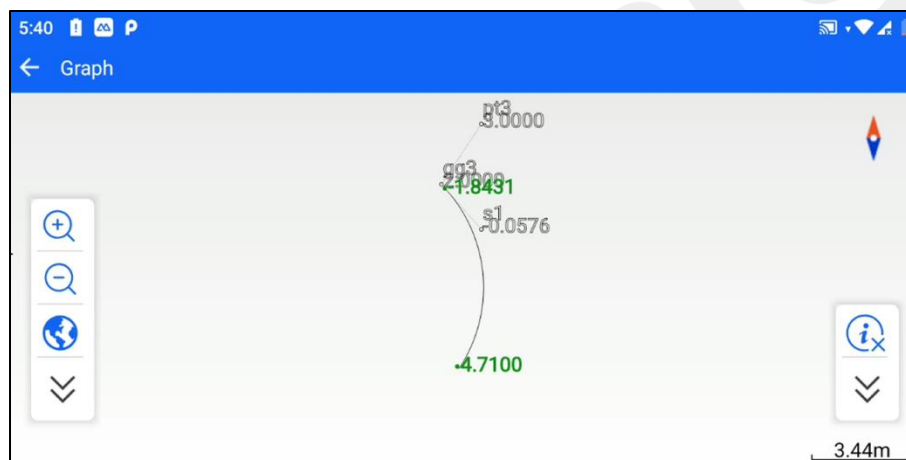

Figure 11-9

[Edit]: You can edit the already inputted intersection data.

[Insert]: Insert an intersection data above the selected point.

[Delete]: Delete the selected intersection data.

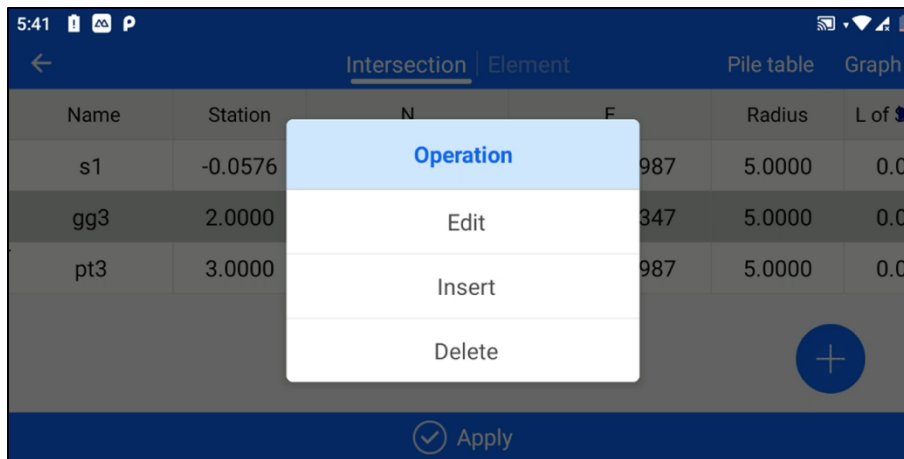

Figure 11-10

Involving virtual intersection and turn-back (turning more than 180 degrees) curves, in addition to the line element method can be supported, in the intersection method, the corresponding virtual intersection point switch is supported.

The first point of the virtual intersection combination is entered normally, and the second point is entered by checking "special intersection" and turning on the virtual intersection switch.

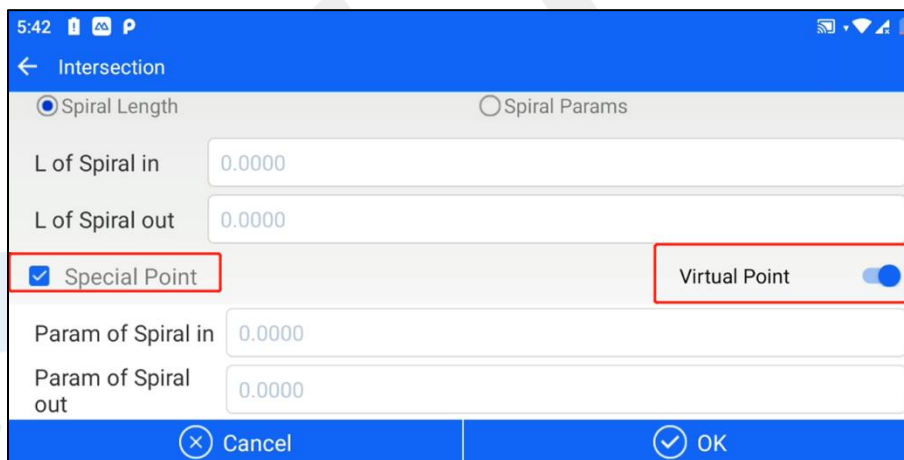

Figure 11-11

Line element method

The line element legal line is also called the building block legal line, which is a combination of complex highway plane lines "whole into zero" decomposition into several line units. If the starting point information of the route plane curve is known, such as coordinates, tangent direction, and radius of curvature, any unit is set up from the starting point and extended in any direction, and the information at the end of this unit, such as coordinates, tangent azimuth, and curve radius, can be calculated, and at the same time, the same information is used as the starting point of the next unit. This is calculated unit by unit downward, just like building blocks.

Simple line segments mainly include straight lines, circular arcs, and gentle curves.

"Straight line": the letter L indicates that only the line element length needs to be entered.

"Arc": the letter A indicates the input starting radius (∞ represents infinity, i.e., a straight line), line element length, and direction (the forward direction is the reference deflection direction).

"Gentle Curve": The letter S indicates that the starting radius, ending radius, line element length, and direction is entered.

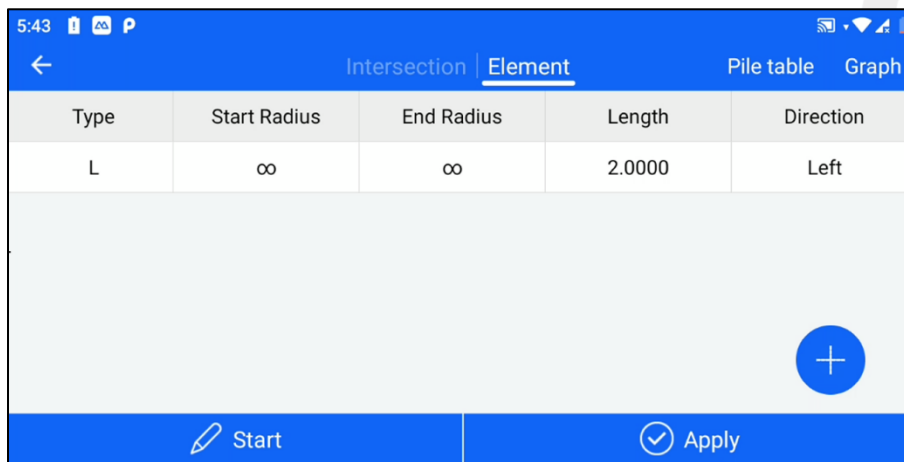

Figure 11-12

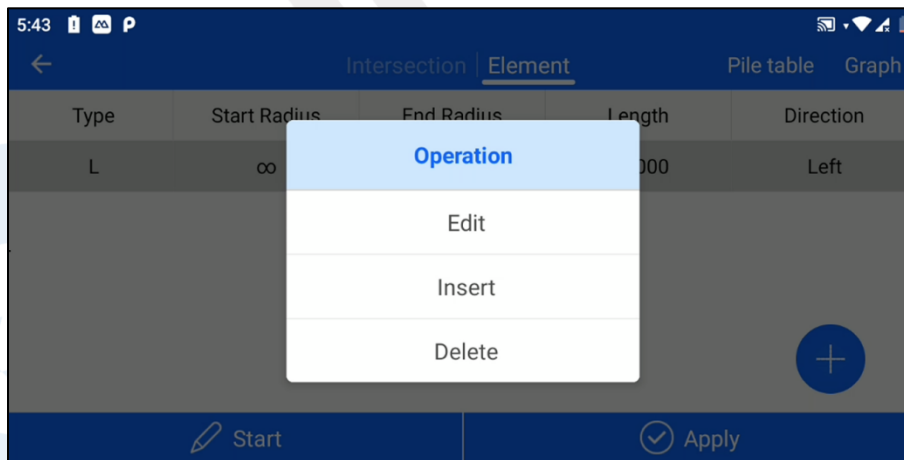

Figure 11-13

[Starting Point]: Click "Starting Point" to enter the starting point interface to edit the starting point information.

[Graph]: See the intersection method

[Apply]: After the line element method data has been edited, click "Apply" to update the current data.

[Edit]: You can edit the already entered line element data.

[Insert]: Insert line metadata above the selected point.

[Delete]: Delete the selected line metadata.

Pile-by-pile table

Enter the interface of flat section design -> pile table, configure, view, and export the flat section mileage data.



id	Station	N	E	Z
0	K0+0.0000	3.0044	-0.8806	0.0000
1	K0+2.0000	5.0044	-0.8806	0.0000

Figure 11-14

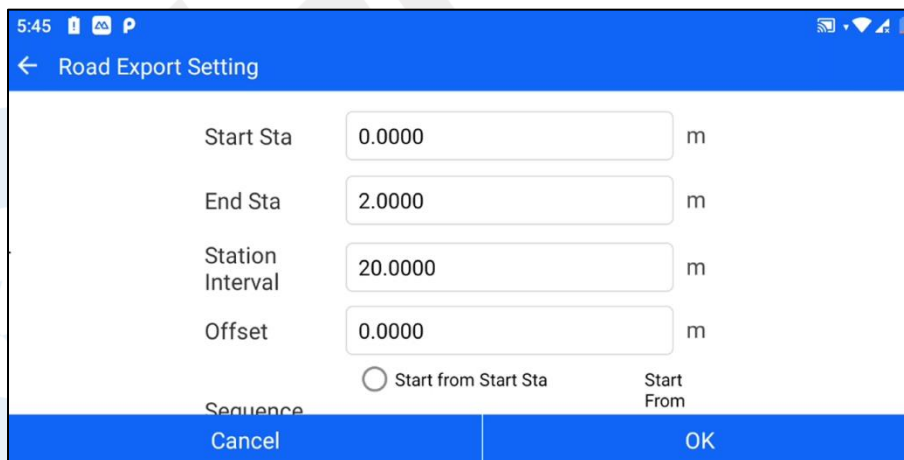

Figure 11-15

[Setting]: You can set the starting mileage, ending mileage, mileage interval, offset distance, and staking method for flat section mileage data export, click OK to apply successfully, and return to the stake-by-stake table interface at the same time.

[Export]: Export the flat section data according to the parameter configuration set in the pile-by-pile export setting interface.

11.1.3 Longitudinal Section Design Line

The longitudinal section is a form of expression of the longitudinal alignment of the road (line-height undulation).

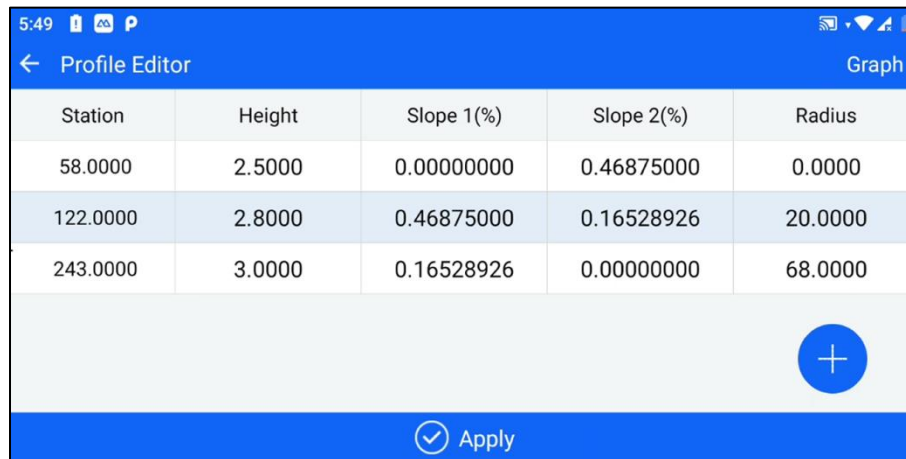

Station	Height	Slope 1(%)	Slope 2(%)	Radius
58.0000	2.5000	0.00000000	0.46875000	0.0000
122.0000	2.8000	0.46875000	0.16528926	20.0000
243.0000	3.0000	0.16528926	0.00000000	68.0000

Figure 11-16

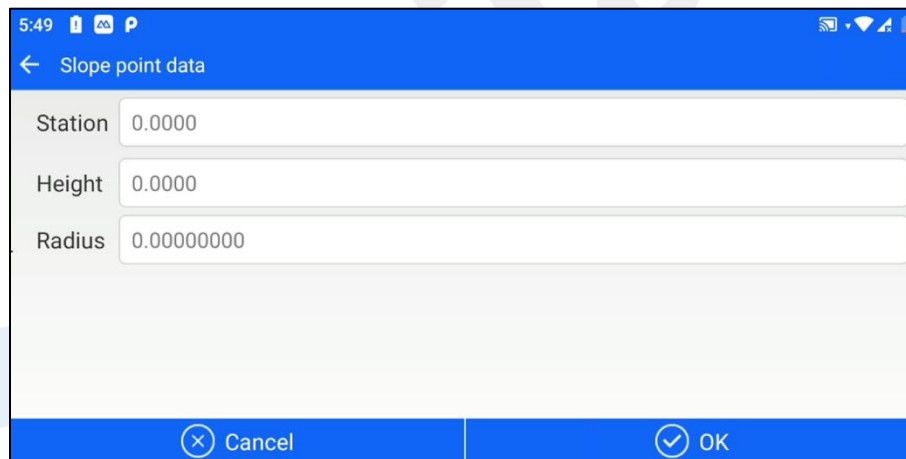

Station:

Height:

Radius:

Figure 11-17

In the general working process, click to add variable slope point data including variable slope point mileage, variable slope point elevation, and radius (longitudinal curve radius), and add all the elements of variable slope points of the line in the order of mileage in turn.

11.1.4 Cross-sectional Design Line

Entering the cross-section editing interface, the software displays three Tab items: standard, super high, and widening. You can create, edit and delete the data information of cross-section, super height, and widening respectively.

Standard

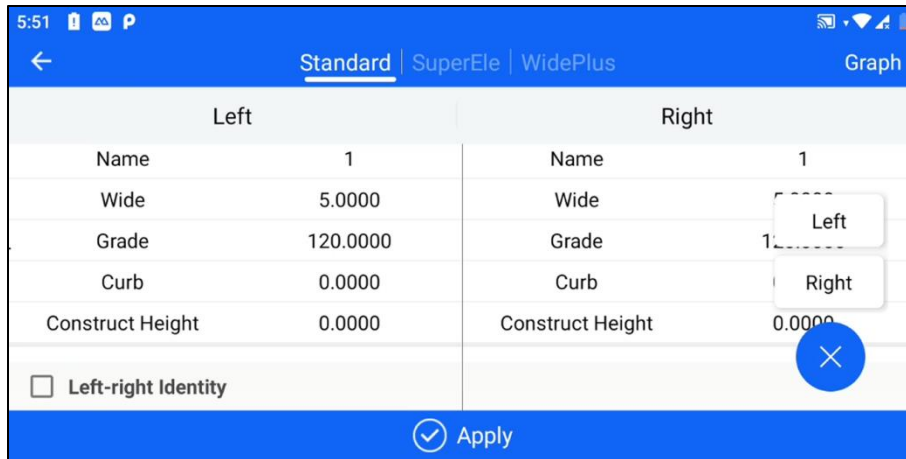

Figure 11-18

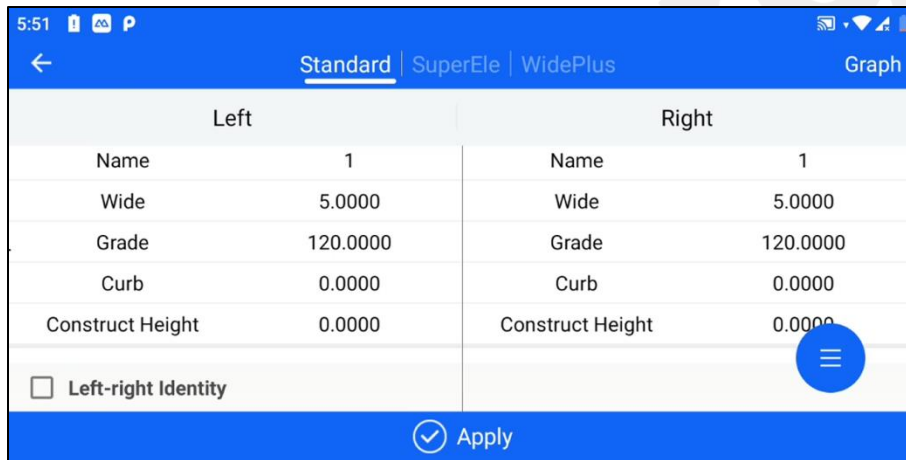

Figure 11-19

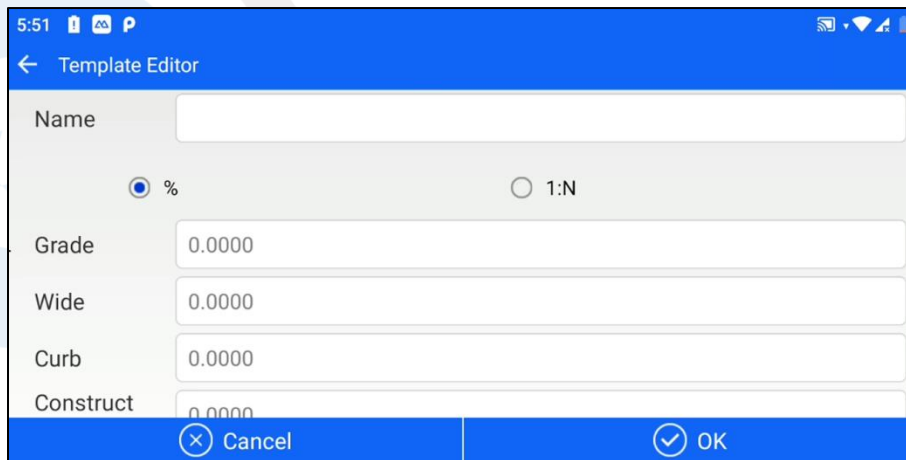

Figure 11-20

[Add]: Click the Add button at the bottom right corner to choose to add left/right cross-sectional panels.

"Name": the name of the board is entered.

"Grade": from the road centerline outward, the slope of the slab is positive for uphill and negative for downhill. The slope value is the ratio of the elevation difference between the two endpoints of the slab and the width of the slab and provides two types of slope ratio input: percentage and proportional.

"Wide": the width of the current board.

"curb": Click to enter the elevation difference of the roadside curb.

[left-right Identity]: Check the box to indicate that the left and right slopes are the same, and the right slope data will be overwritten as symmetrical data with the left slope (Note: the original right slope data will be lost and can't be recovered), check the box to add, and the same left and right cross-sectional slabs will be created synchronously.

Superelevation

To reduce the centrifugal force generated by the vehicle driving on the curved road, the road is made into a one-way cross slope in the form of high outside and low inside called super high.

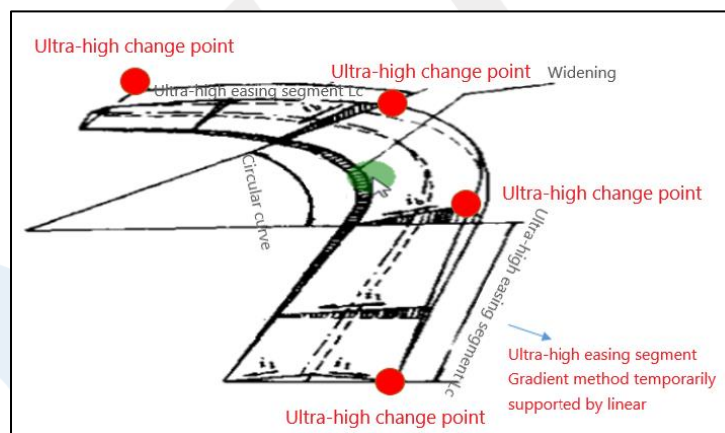

Figure 11-21

In the [SuperEle] section, you can enter the super high change point information according to the design drawing.

Select the cross-sectional slab that corresponds to the role of superelevation, and use the motorway superelevation as an example to explain here.

Station	Grade	Gradual	Plates
0.0000	-1.5000	Linear	Left:2
10.0000	2.0000	Linear	Left:2
20.0000	2.0000	Linear	Left:2
30.0000	-1.5000	Linear	Left:2

Figure 11-22

The Superelevation is located in the "left side of the motor vehicle" section, entered as follows.

Station	Grade	Gradual	Plates
0.0000	-1.5000	Linear	Left:2
10.0000	2.0000	Linear	Left
20.0000	2.0000	Linear	Right
30.0000	-1.5000	Linear	Left:2

Figure 11-23

Station	Grade	Gradual	Plates
0.0000	-1.5000	Linear	Left:2
10.0000	2.0000	Linear	Left:2

1
road ✓

Figure 11-24

To simplify the example, we assume that the ultra-high change points on the drawing read as follows.

Superelevation Change Point 1: Mileage 0 Slope -1.5%

Superelevation Change Point 2: Mileage 10 Slope 2%

Superelevation Change Point 3: Mileage 20 Slope 2%

Superelevation Change Point 3: Mileage 30 Slope -1.5%

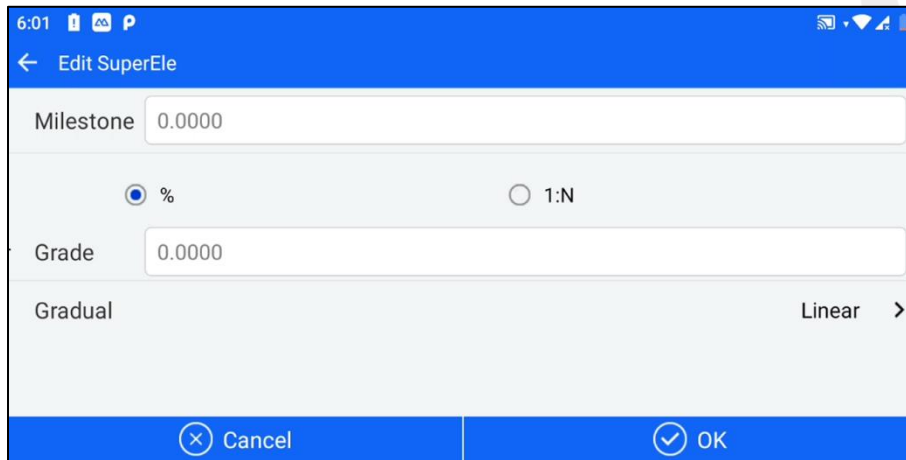

Figure 11-25



Station	Grade	Gradual	Plates
0.0000	-1.5000	Linear	Left:2
10.0000	2.0000	Linear	Left:2
20.0000	2.0000	Linear	Left:2
30.0000	-1.5000	Linear	Left:2

Figure 11-26

Finish adding the four Superelevation points in turn, and you can view them correspondingly in the [Graph] screen.

Click "Cross Section"  to view the cross-section height information of the current location corresponding to the mileage.



Figure 11-27

WidePlus

To transition the pavement from the normal width to the curve, a widened width is set so that a widening mitigation section is required. On the widening mitigation section, the pavement has a gradually changing width. The setting of widening transition can be used in different ways according to the nature and grade of the road.

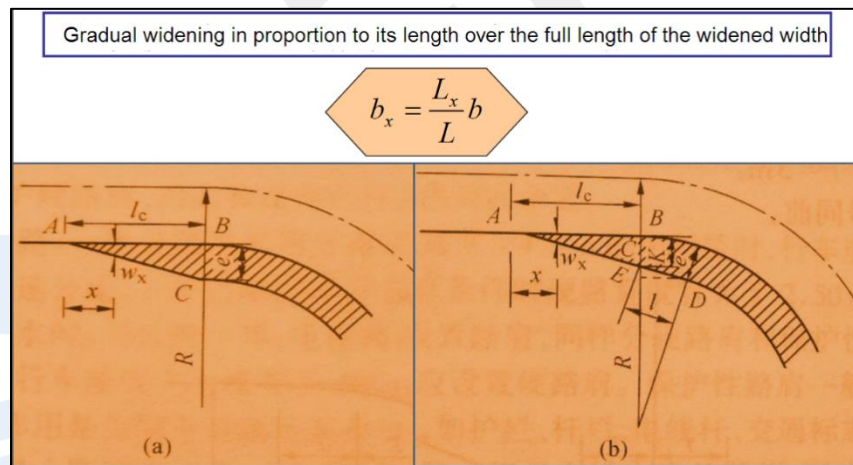

Figure 11-28

In the [WidePlus] section, you can enter the widening change point information according to the design drawings.

Select the cross-sectional plate that corresponds to the widening effect, and take the motorway widening as an example here.

The widening is located in the "right-hand motor vehicle" section, entered as follows.

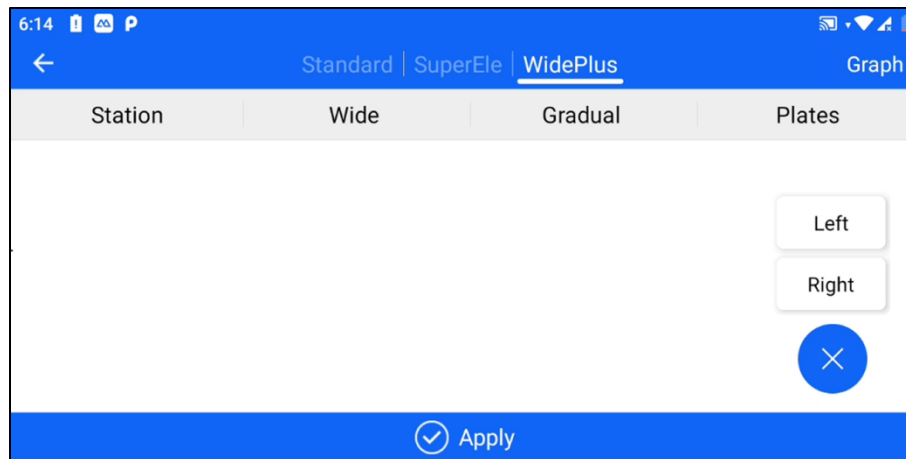

Figure 11-29

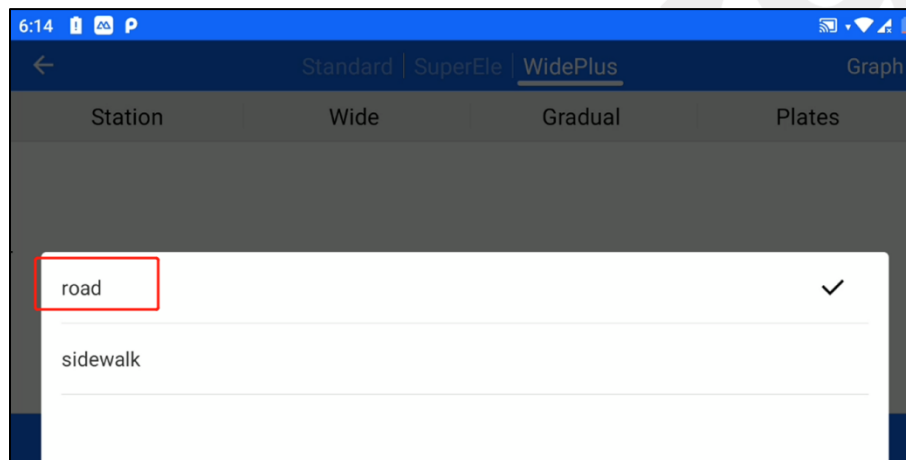

Figure 11-30

To simplify the example, we assume that the widening change point on the drawing reads as follows.

WidePlus change point 1: Mileage 0 Width 4.5



WidePlus change point 2: Mileage 10 Width 5.2

WidePlus change point 3: Mileage 20 Width 6

WidePlus change point 4: Mileage 30 Width 5.2

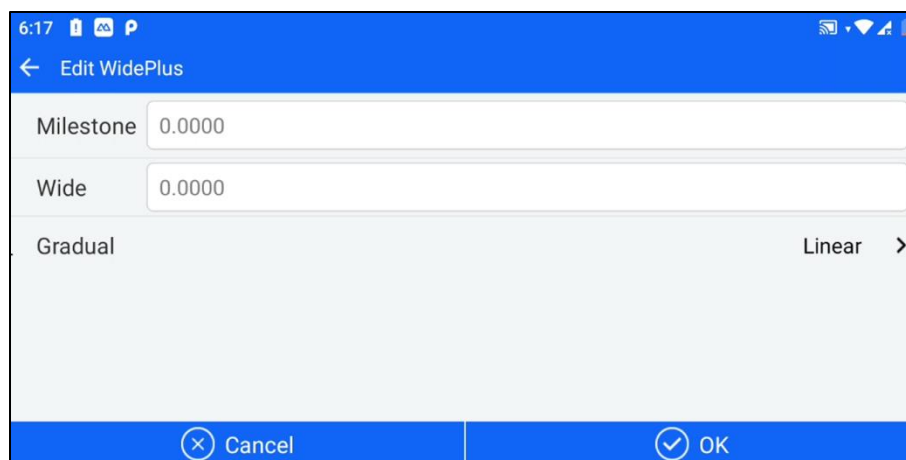
WidePlus change point 5: Mileage 40 Width 4.5



6:17  

← Edit WidePlus

Milestone

Wide

Gradual Linear >

Figure 11-31

Chapter 12

Bridge

This chapter contains:

- Pier Design
- Bridge Design
- Cone Design
- Pier Stakeout
- Tapered Slope S.O



12.1 Pie Design

Bridge pier is the collective name of the bridge pier and bridge abutment, which is the building supporting the superstructure of the bridge. The overall steps of pier and abutment stakeout with T-Survey software are ① enter [Pie Design] to design pier and abutment formwork; ② enter "+" to design the location of pier and abutment on the bridge; ③ enter [Pier Stakeout] to stakeout the feature points of pier and abutment.

The pier design on T-Survey is based on the road, i.e., the road design is required before designing the piers. The steps for setting up the pier template library are as follows.

1. Pre-requisite: have been in the [Road] - [Road Design] module to design a road (including at least the flat section).
2. Enter the [Pier Formwork Library] and select the designed road in the top column.

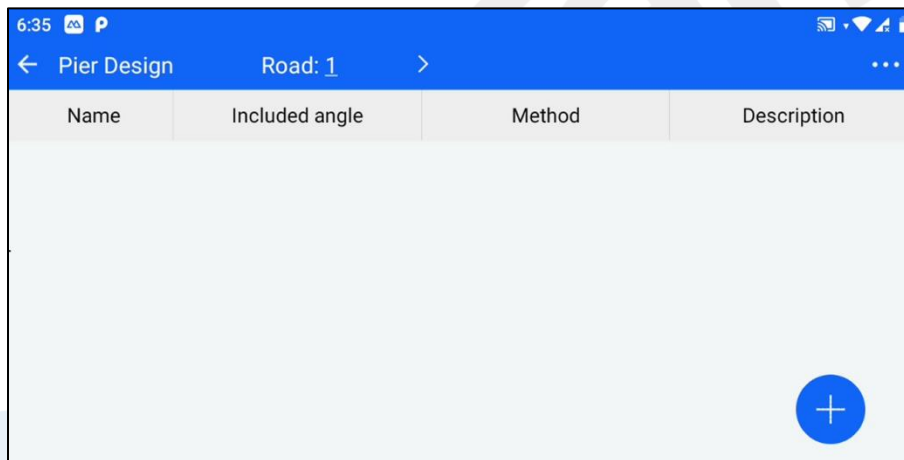

Figure 12-1

3. After the road is selected, click the bottom right corner of the hover "+" button to enter the pier template design interface.

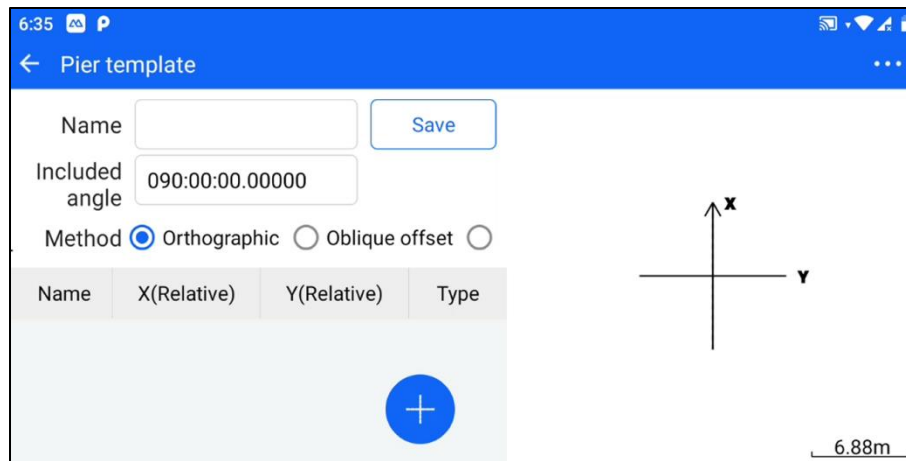

Figure 12-2

The parameters to be set are template name, angle, and layout method. (0,180) when the layout method is orthogonal, and (0,180) when the layout method is oblique intersection vertical distance or oblique intersection oblique distance.

4. In the pier template design interface, click the hover "+" button, and you can enter the feature point to add the interface.

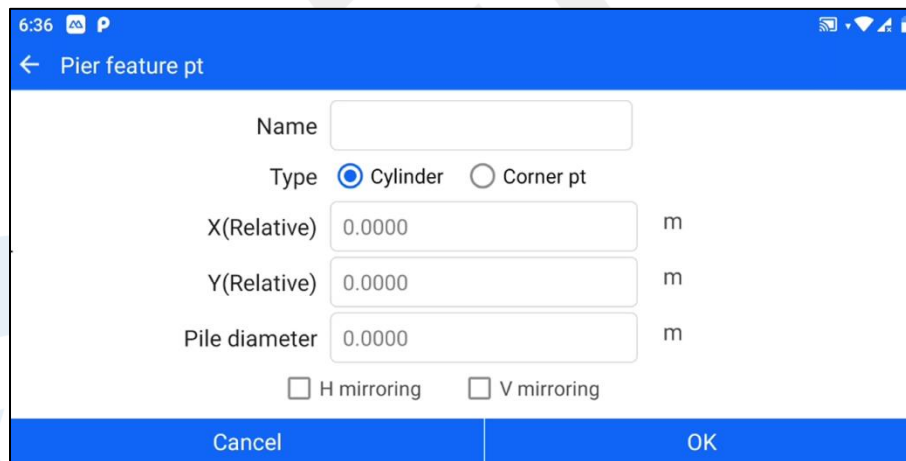
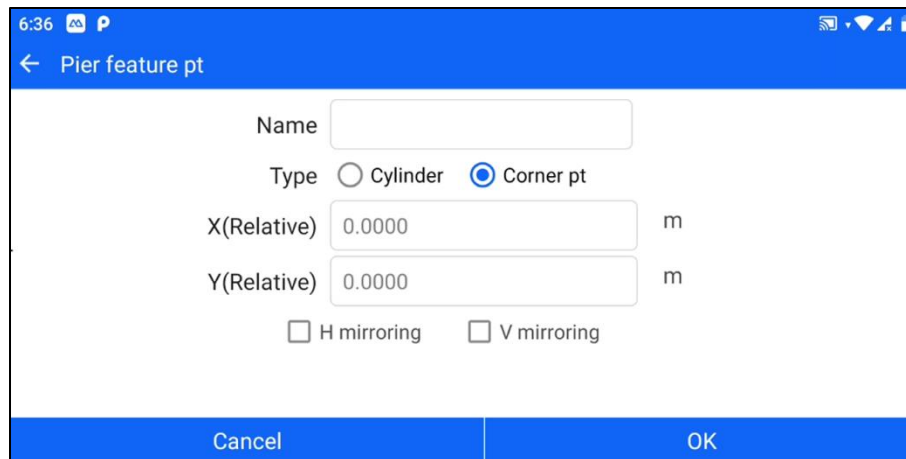

Figure 12-3

If the feature point type is the cylinder, the parameters to be set are point name, vertical coordinate, horizontal coordinate, and pile diameter. The pile diameter should be larger than 0.



6:36 P

← Pier feature pt

Name

Type Cylinder Corner pt

X(Relative) m

Y(Relative) m

H mirroring V mirroring

Cancel OK

Figure 12-4

If the feature point type is selected as a corner point, the parameters to be set are point name, vertical coordinate, and horizontal coordinate.

Only check the "V mirroring": the cross-axis determined by the pier angle as the reference for longitudinal mirroring to calculate the mirror point.

Only check the "H mirroring": the vertical axis of the horizontal axis determined by the angle with the pier as the reference, the horizontal mirror to calculate the mirror point.

Simultaneously check the "H mirroring", and "V mirroring": respectively, the horizontal and vertical axis determined by the pier angle as the reference, calculate the horizontal mirror, vertical mirror, and horizontal and vertical mirror points, that is, a total of three mirror points.

5. After the completion of the feature point settings, click "OK" to return to the pier template design interface, the right side will correspond to the relative position of the feature point and the horizontal and vertical axes, which point to the arrow above indicates the direction of the road forward.

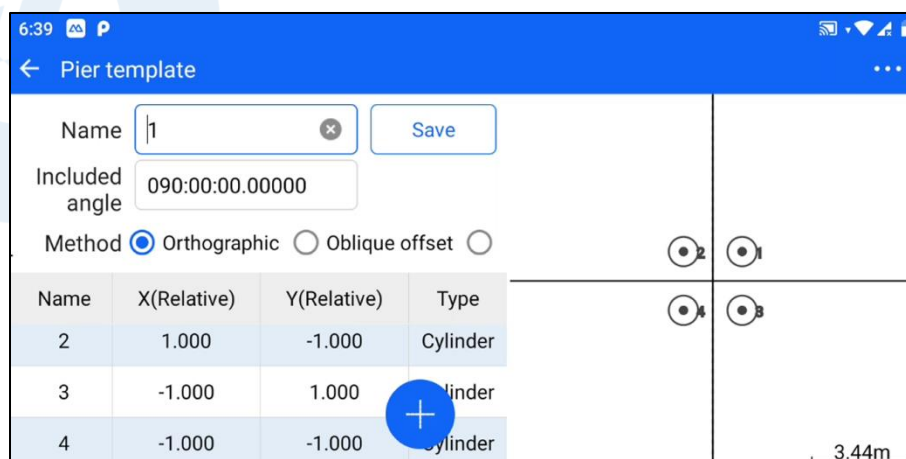

6:39 P

← Pier template

Name Save

Included angle

Method Orthographic Oblique offset

Name	X(Relative)	Y(Relative)	Type
2	1.000	-1.000	Cylinder
3	-1.000	1.000	Cylinder
4	-1.000	-1.000	Cylinder

3.44m

Figure 12-5

6. Click "Save", that is, to complete a pier template design.

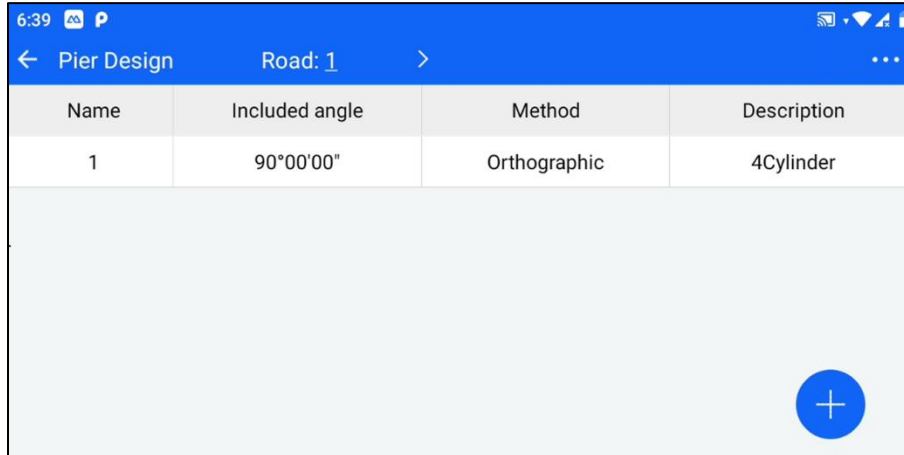

Name	Included angle	Method	Description
1	90°00'00"	Orthographic	4Cylinder

Figure 12-6

Click a template in the list of pier templates to "delete"/"edit" the template.

Click "..." -> "clear" in the upper right corner to empty the list of pier templates.

12.2 Bridge Design

Once the pier formwork design is completed, the bridge layout can be carried out to define the distribution of piers in the bridge. The steps of the bridge layout are as follows.

1. Pre-condition: At least one pier template has been designed in the [Bridge] - [Pie Design] module.
2. Go to [Bridge Design] and select the designed road at the top bar.

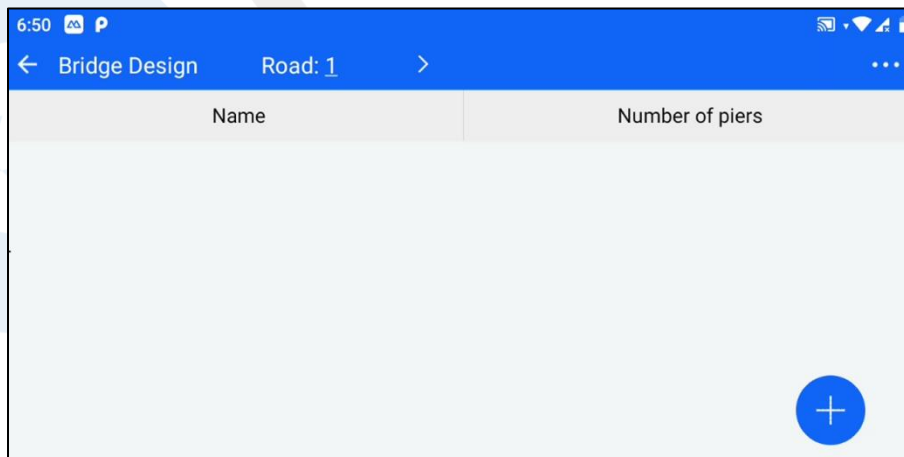

Name	Number of piers
------	-----------------

Figure 12-7

3. After selecting the road, click the "+" hover button at the bottom right corner to enter the new bridge interface. The parameters you need to set are the bridge name.

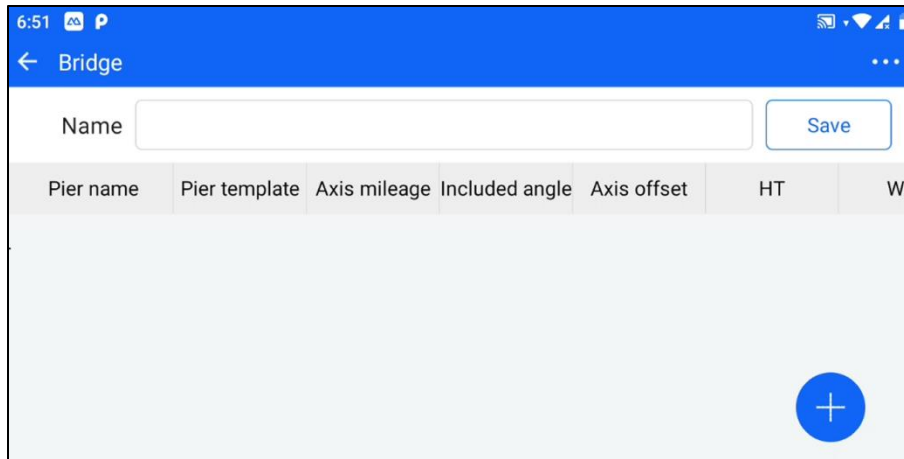

Figure 12-8

4. In the new bridge interface, click the hover "+" button to enter the pier layout interface.

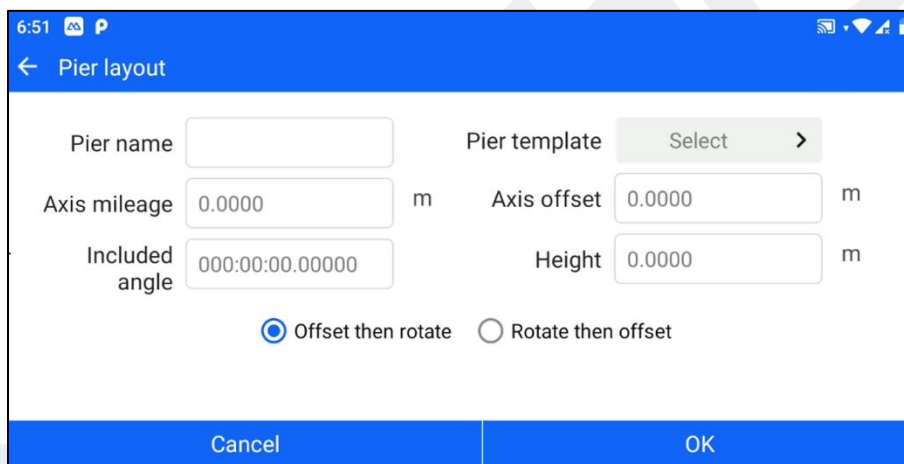

Figure 12-9

The parameters to be set are pier name, pier template selection, axis mileage, axis offset, axis angle, and elevation. If the user selects the pier template as oblique intersection slope distance / oblique intersection vertical distance, the axis line angle is not editable, and it is directly displayed as the angle in the template by default.

Check "offset then rotate": use the axis as a reference, first offset based on "axis offset", then rotate based on "axis angle".

Check "Rotate then Offset": the axis is used as the reference, and the rotation is based on the "axis angle" first, and then the offset is based on the "axis offset".

5. After the pier arrangement is complete, click "OK" to return to the bridge's new interface, the bottom will correspond to the bridge just added piers.

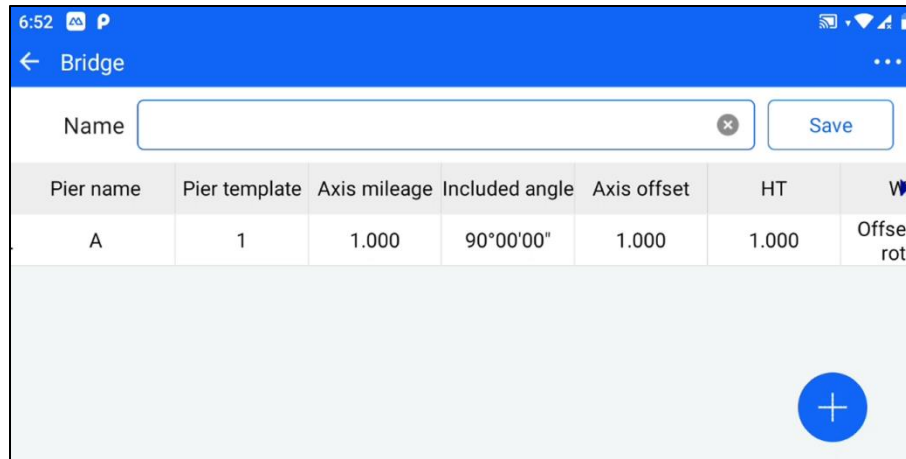

Figure 12-10

Click a template in the pier list, you can "delete"/"edit" the pier operation.

6. Click "Save" to complete a bridge design.

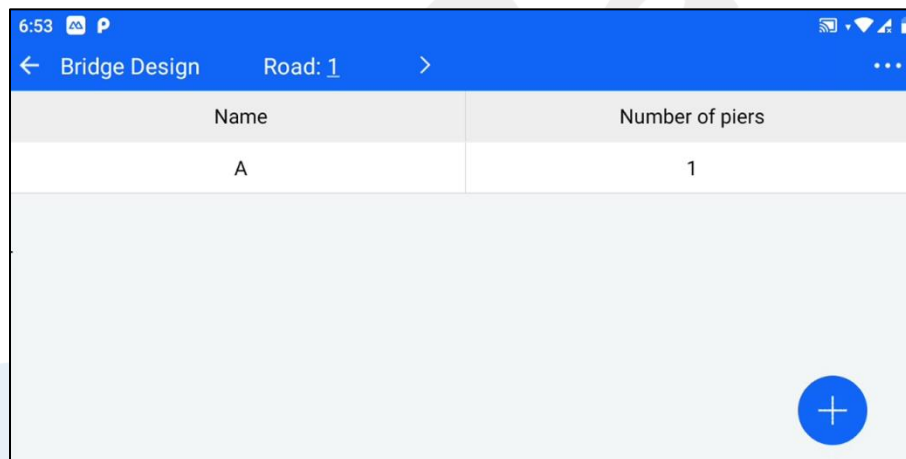

Figure 12-11

Click a bridge in the bridge list to "delete"/"edit" the bridge.

Click "... " -> "Clear" in the upper right corner to clear the bridge list.

12.3 Cone Design

Cone slope refers to the conical slope built at the joint of the bridge and roadbed to protect the slope of the road embankment from scouring. The overall steps of cone slope Stakeout with T-Survey software are ① enter [Cone Design] to design cone slope; ② enter [Conical Slope S.O] and sample the target points of cone slope according to the set equal fraction.

The cone slope design on T-Survey is based on the road, i.e., the road design is required before

designing the cone slope. The steps of cone slope design are as follows.

1. Pre-requisite: have been in the [Road] - [Road Design] module to design a road (including at least the flat section).
2. Enter [Cone Design] and select the designed road in the top bar.

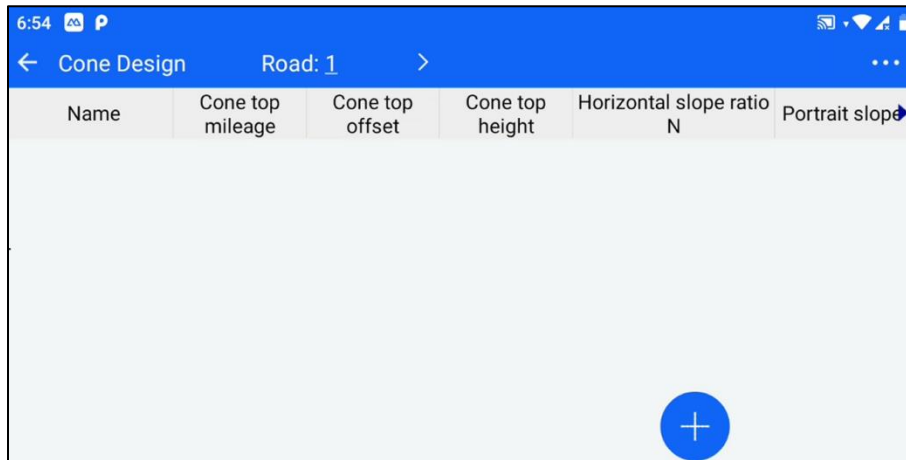

Figure 12-12

3. After choosing the road, click the "+" hover button at the bottom right corner to enter the cone slope design interface.

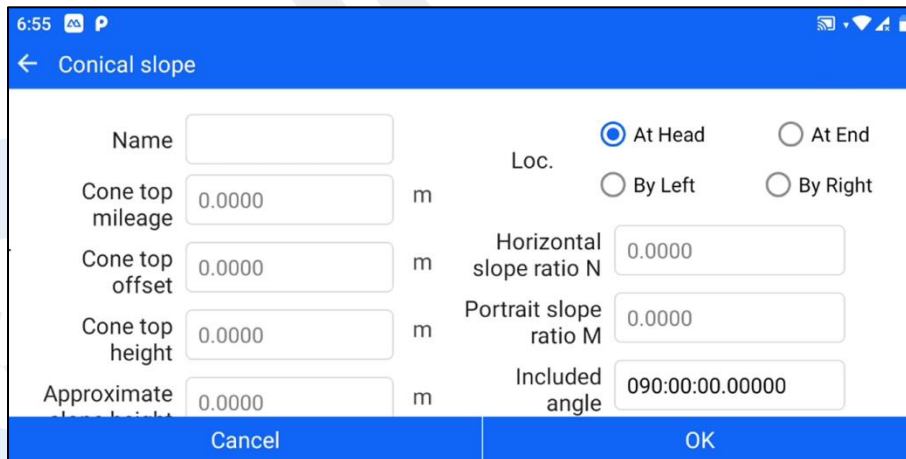

Figure 12-13

The parameters to be set are cone slope name, position, cone top mileage, cone top offset, cone top elevation, approximate slope height, transverse slope ratio N, longitudinal slope ratio M, and axial pinch angle.

The approximate slope height, horizontal slope ratio N and vertical slope ratio M cannot be less than 0.

4. After the cone slope setting is finished, click "OK" to return to the cone slope design library, that is, to

complete a cone slope design.

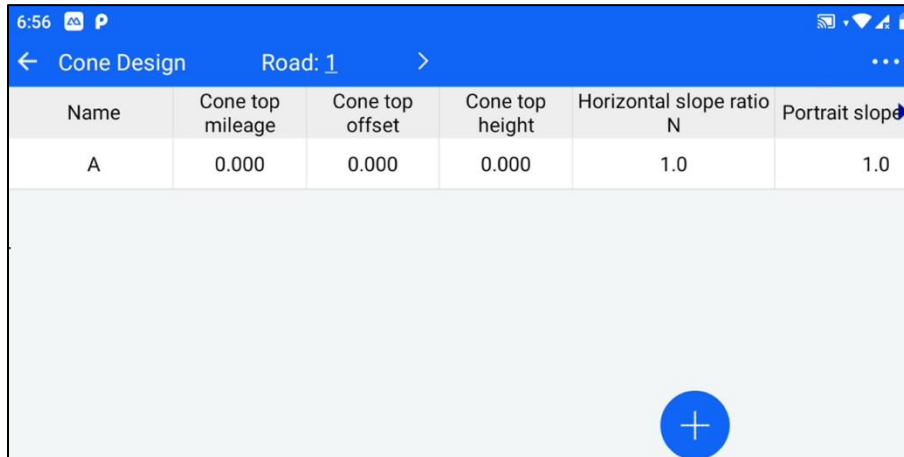

Name	Cone top mileage	Cone top offset	Cone top height	Horizontal slope ratio N	Portrait slope
A	0.000	0.000	0.000	1.0	1.0

Figure 12-14

Click a tapered slope in the tapered slope design list to "delete"/"edit" the tapered slope.

Click "... " -> "Clear" in the upper right corner to clear the cone slope list.

12.4 Pier Stakeout

The pier stakeout interface can be placed on the road data of the bridge pier data feature points. The steps of the stakeout operation are as follows.

1. Select road data: click the "Road" button, jump to the road library, and click to select the road data that need to be put back into the sample interface.

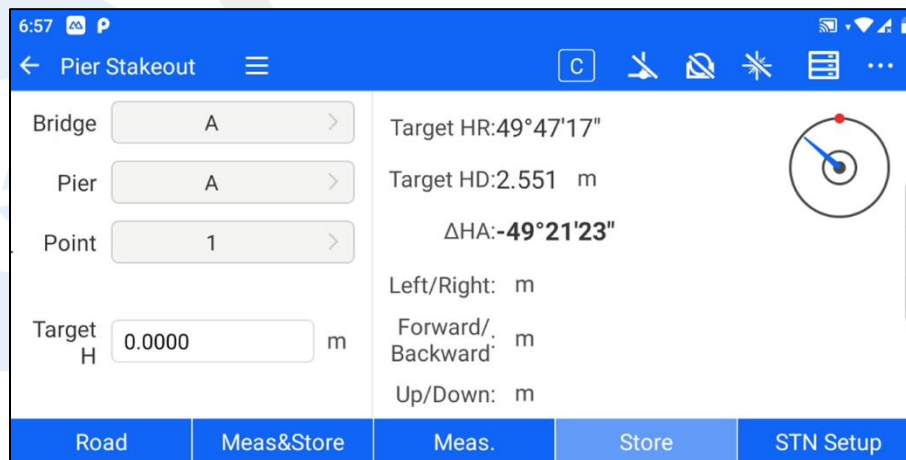

Bridge	A	Target HR: 49°47'17"
Pier	A	Target HD: 2.551 m
Point	1	ΔHA: -49°21'23"
Target H	0.0000 m	Left/Right: m
		Forward/Backward: m
		Up/Down: m

Road Meas&Store Meas. Store STN Setup

Figure 12-15

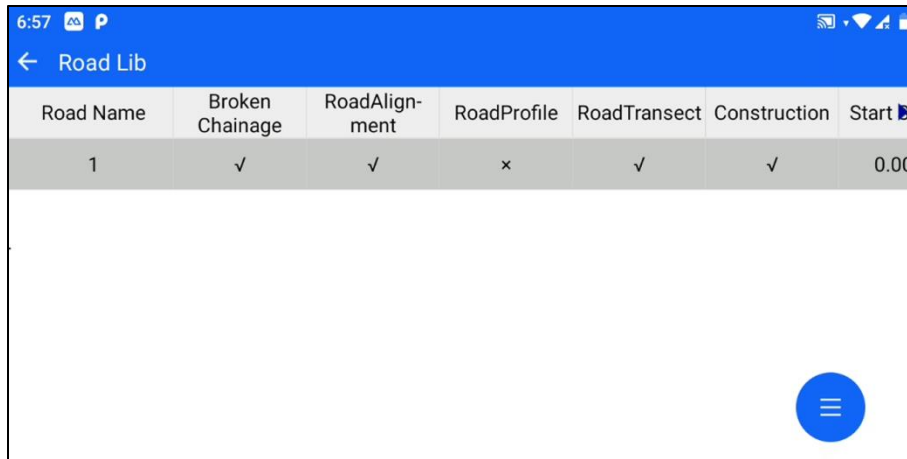

Road Name	Broken Chainage	RoadAlign-ment	RoadProfile	RoadTransect	Construction	Start St
1	✓	✓	x	✓	✓	0.00

Figure 12-16

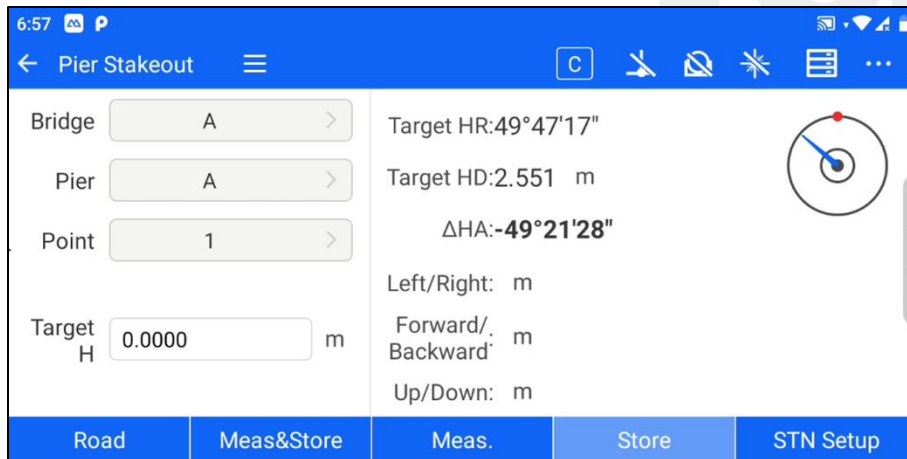

Bridge: A
 Pier: A
 Point: 1
 Target H: 0.0000 m

Target HR: 49°47'17"
 Target HD: 2.551 m
 ΔHA: -49°21'28"
 Left/Right: m
 Forward/Backward: m
 Up/Down: m

Road Meas&Store Meas. Store STN Setup

Figure 12-17

2. Feature point selection: After selecting the road data, click the bridge column, pier column, and feature point column, respectively, to select the current road data need to put the bridge, pier, and its feature points.

After selecting a road, the first feature point of the first pier of the first bridge of that road will be selected by default.

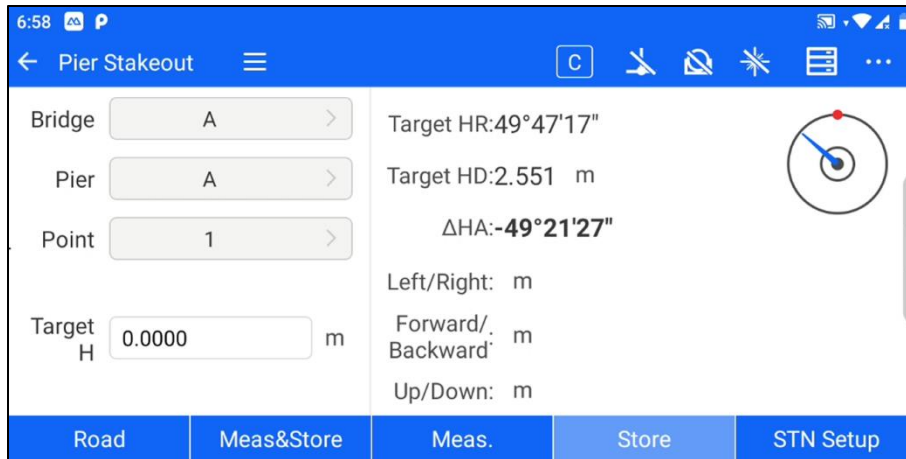

Figure 12-18

3. Pier stakeout: After selecting the feature points to be stakeout, click on the meas&store/meas.- Store to calculate the stakeout information and expand the graphic interface on the right side to show the position relationship between the current position, prism points, and stakeout points.

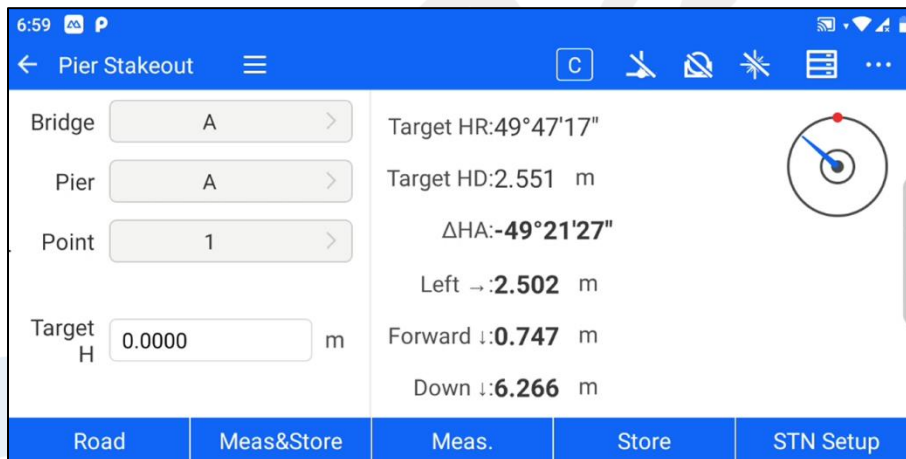

Figure 12-19

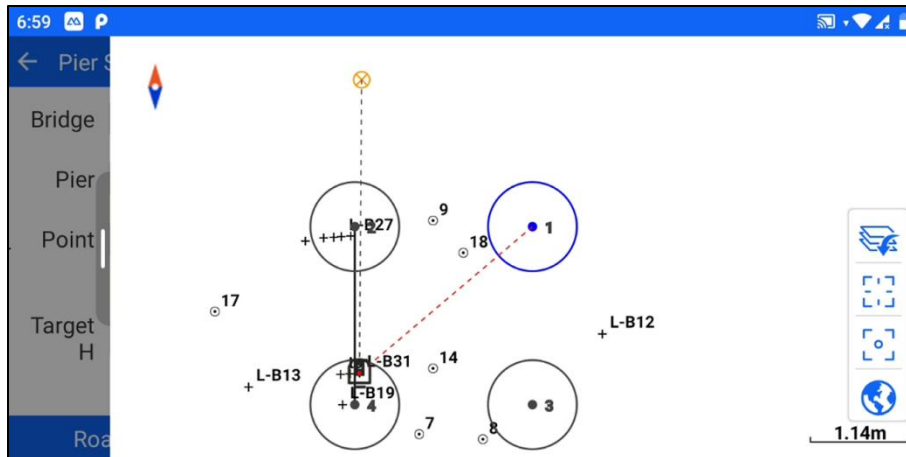

Figure 12-20

12.5 Conical Slope S.O

The conical slope stakeout interface can stakeout the target points of the cone slope in the road data. The steps of the stakeout operation are as follows.

1. Select road data: click the "Road" button, jump to the road library, and click to select the road data that need to be put back into the sample interface.

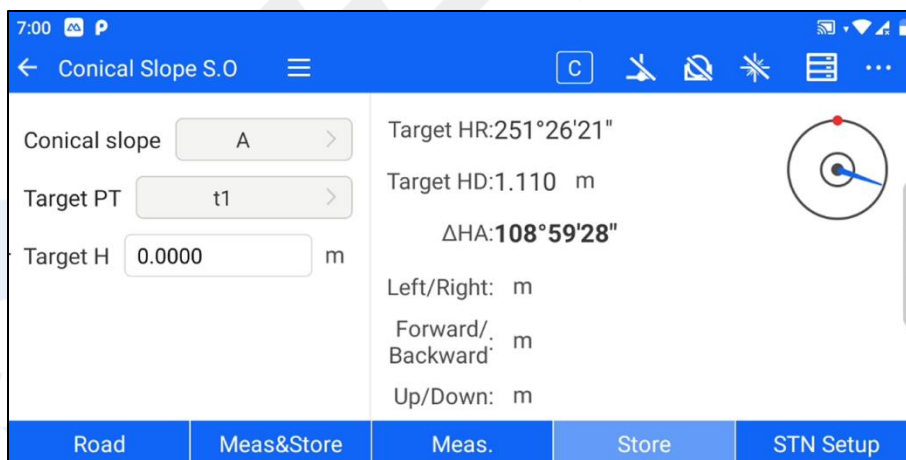
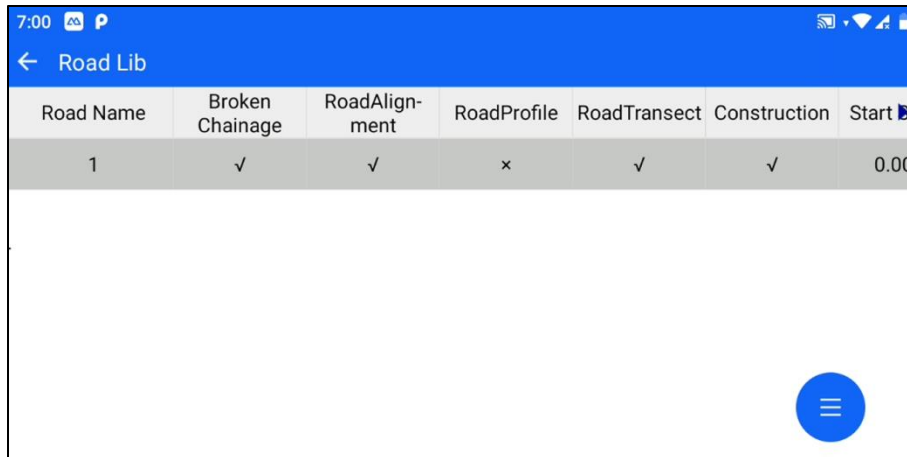

Figure 12-21



Road Name	Broken Chainage	Road Alignment	Road Profile	Road Transect	Construction	Start St
1	✓	✓	x	✓	✓	0.00

Figure 12-22

2. Target point selection: After selecting the road data, click on the cone slope column to select the cone slope of the current road data that needs to be stakeout. The software will pop up the number of equal fraction settings, and after the setting is completed, the target point column will display the corresponding number of target points according to the number of equal fractions.

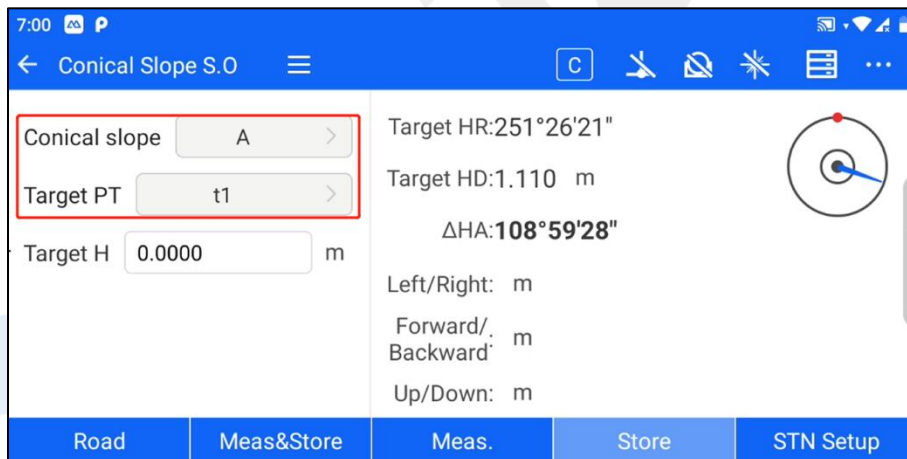

Conical slope	A	Target HR:251°26'21"
Target PT	t1	Target HD:1.110 m
Target H	0.0000 m	ΔHA:108°59'28"
		Left/Right: m
		Forward/Backward: m
		Up/Down: m

Figure 12-23



Figure 12-24

3. Cone slope Stakeout: After selecting the target points to be sampled, click on the meas& store/meas.t-Store to calculate the Stakeout information and expand the graphic interface on the right to show the position relationship between the current position, prism points, and Stakeout points.

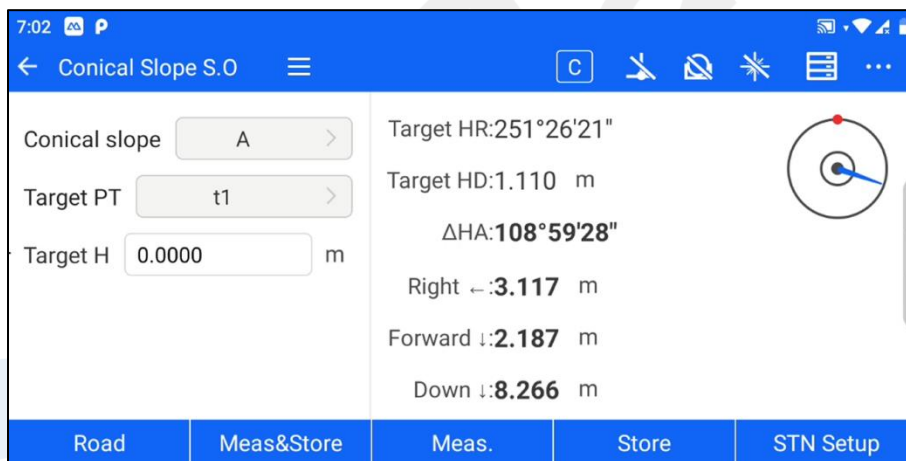

Figure 12-25

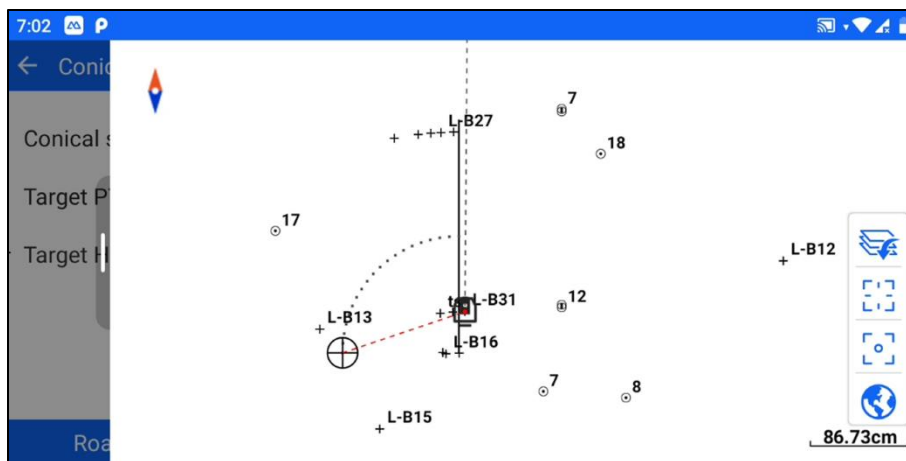

Figure 12-26

Chapter 13

Tunnel

This chapter contains:

- Tunnel Section Library
- Feature Points
- Tunnel Over-under Break



Hi-Target

13.1 Tunnel Section Library

Depending on the tunnel construction stage, tunnel sections can be roughly divided into the excavation, primary support, and second lining. The overall steps of tunnel over-excavation using T-Survey software are ① enter [Tunnel Section Library] to design the tunnel section (excavation, primary support, second lining); ② enter [Feature Point] to add tunnel feature points when needed; ③ enter [Tunnel Over-under Break] to select tunnel section or feature points for over-excavation operation.

Tunnels on T-Survey are based on roads, i.e. road design is required before designing the tunnel cross-section. The steps to set up the tunnel cross-section library are as follows.

1. Pre-requisite: have been in the [Road] - [Road Design] module to design a road (including at least the flat section).
2. Enter [Tunnel Section Library] and select the designed road at the top bar.

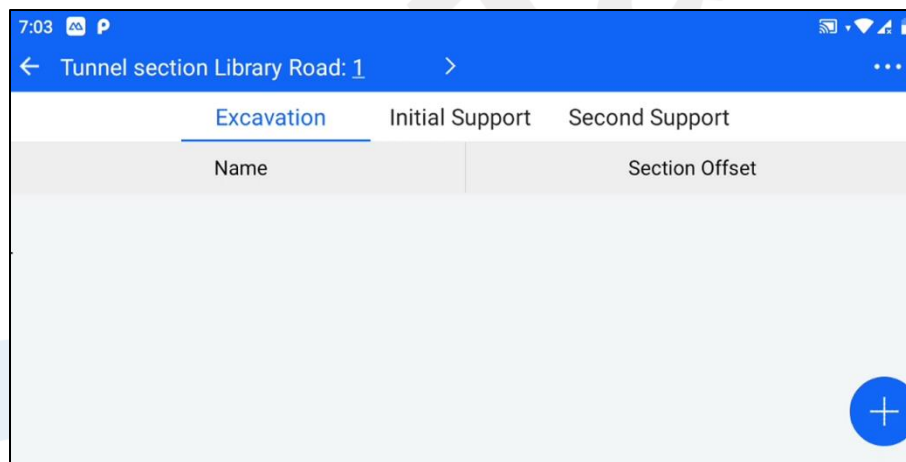

Figure 13-1

3. After selecting the road, select the type of section to be designed (excavation, primary support, second lining), and click the "+" hover button at the bottom right corner to enter the tunnel section design interface.

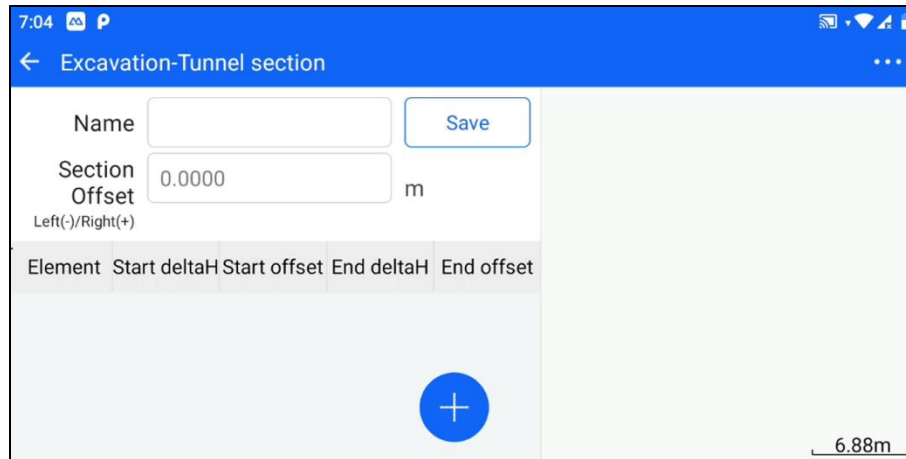

Figure 13-2

Different section types design section processes and methods are the same, the parameters to be set are name, offset in the tunnel, and section line element.

4. In the tunnel section design interface, click the hover "+" button to bring up the section line element selection box, the options are "line", "arc" and "circle".

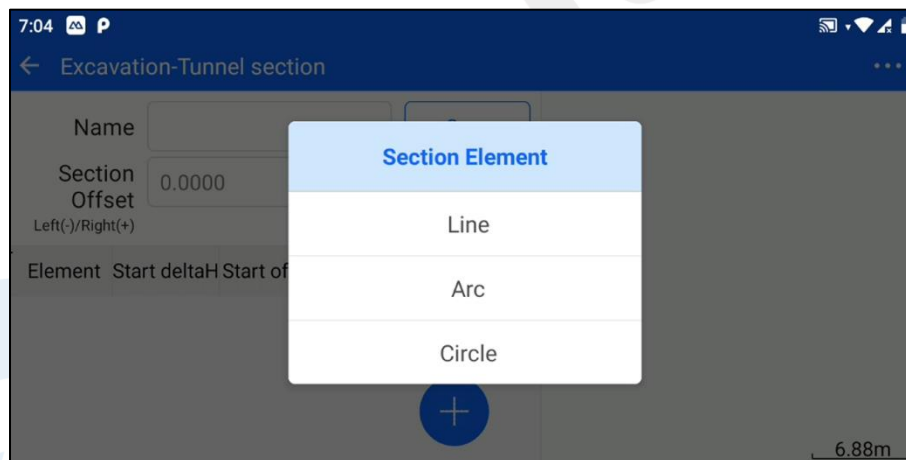

Figure 13-3

If the section element type is a straight line, the parameters to be set start elevation difference, start offset, end elevation difference, and end offset. The start point cannot be the same as the endpoint.



Figure 13-4

If you select the section line element type as arc, you have the following three options to add.

① "Start point - End point - Turning angle": the parameters to be set start elevation difference, start offset, end elevation difference, end offset, and rotation angle (cannot be 0).

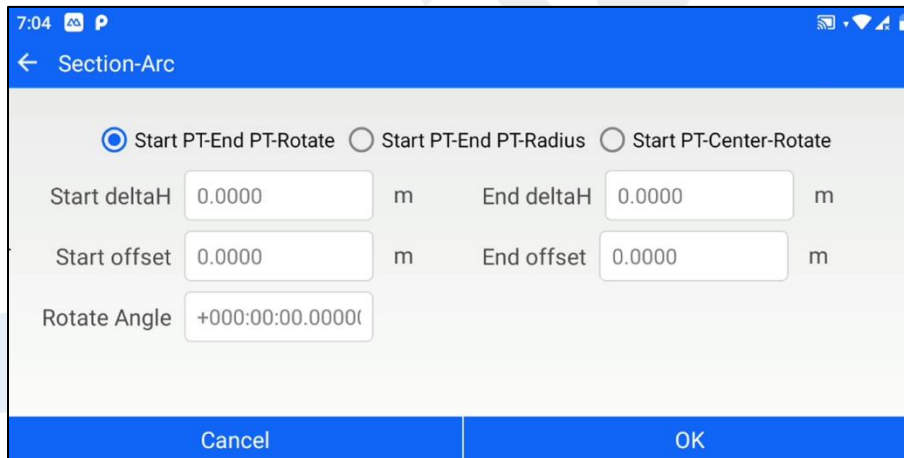
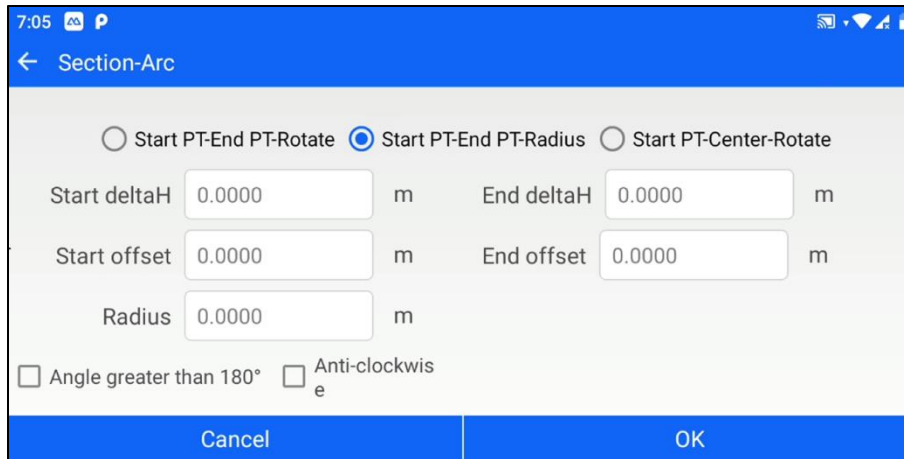

Figure 13-5

② "Start - End - Radius": the parameters to be set start elevation difference, start offset, end elevation difference, end offset, radius (cannot be less than half of the start and end distance), turning angle greater than 180° and counterclockwise.



7:05 7:05

← Section-Arc

Start PT-End PT-Rotate
 Start PT-End PT-Radius
 Start PT-Center-Rotate

Start deltaH m End deltaH m

Start offset m End offset m

Radius m

Angle greater than 180° Anti-clockwise

Cancel OK

Figure 13-6

③ "Start point-circle center-rotation angle": the parameters to be set are start elevation difference, start Offset, circle center elevation difference, circle center Offset, and rotation angle (cannot be 0).

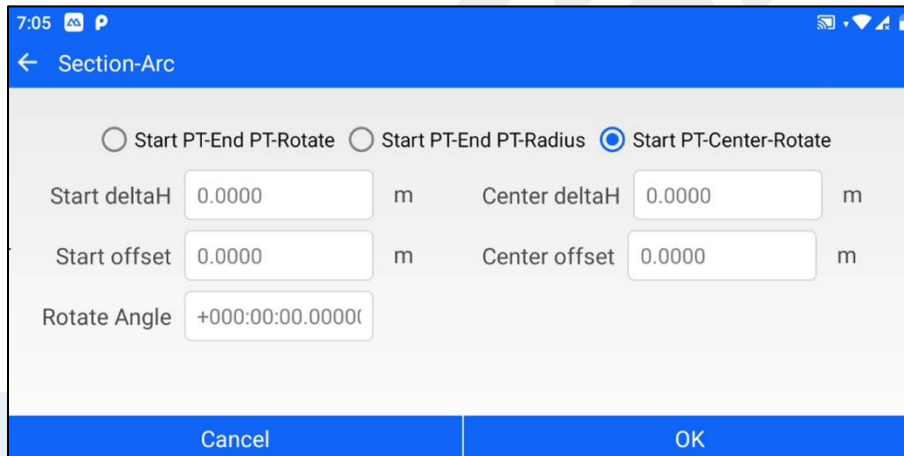

7:05 7:05

← Section-Arc

Start PT-End PT-Rotate
 Start PT-End PT-Radius
 Start PT-Center-Rotate

Start deltaH m Center deltaH m

Start offset m Center offset m

Rotate Angle

Cancel OK

Figure 13-7

If the section line element type is selected as the circle, the parameters to be set are circle center elevation difference, circle center offset, and radius (cannot be 0).



Figure 13-8

5. After setting the section line element, click "OK" to return to the tunnel section design interface, the right side will show the relative position of the section line element and the tunnel centerline.

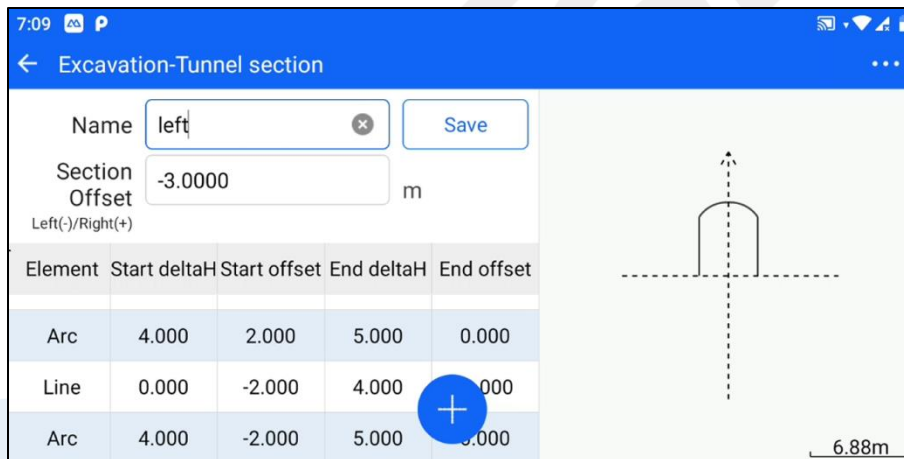

Element	Start deltaH	Start offset	End deltaH	End offset
Arc	4.000	2.000	5.000	0.000
Line	0.000	-2.000	4.000	0.000
Arc	4.000	-2.000	5.000	0.000

Figure 13-9

Click "..." -> "Clear" in the upper right corner to clear the list of section line elements.

6. Click "Save" to complete a tunnel section design.

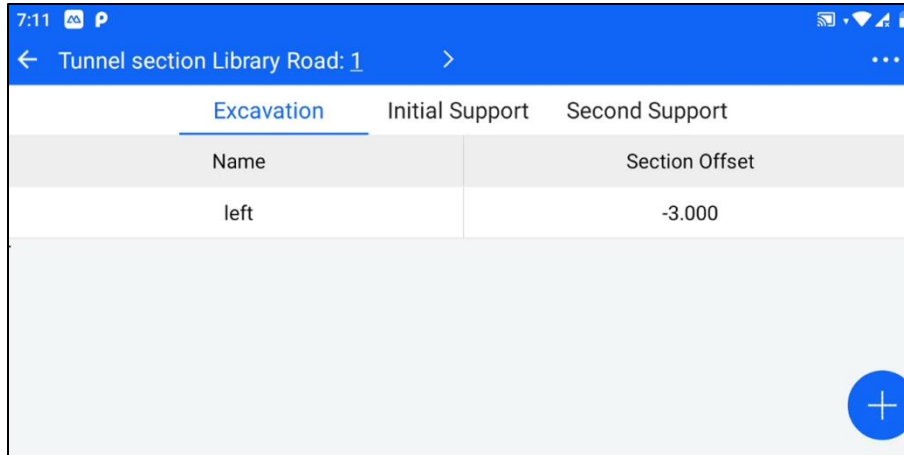

Tunnel section Library Road: 1	
Excavation Initial Support Second Support	
Name	Section Offset
left	-3.000

Figure 13-10

Click a section in the tunnel section list, you can "delete"/"edit" the section operation.

Click "... " -> "Clear" in the upper right corner to clear the list of tunnel sections.

13.2 Tunnel Feature Points

To set the tunnel feature points, proceed as follows.

1. Pre-requisite: have been in the [Road] - [Road Design] module to design a road (including at least the flat section).
2. Go to [Tunnel Feature Point] and select the designed road at the top bar.

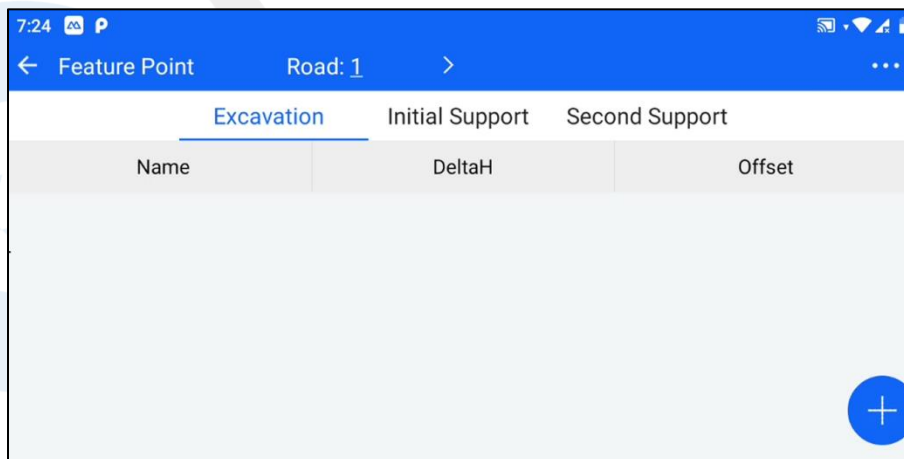

Feature Point Road: 1		
Excavation Initial Support Second Support		
Name	DeltaH	Offset

Figure 13-11

3. After selecting the road, select the type of section where the feature points are located (excavation, primary support, second lining), and click the bottom right corner of the "Add" hover button to enter the tunnel feature point design interface.

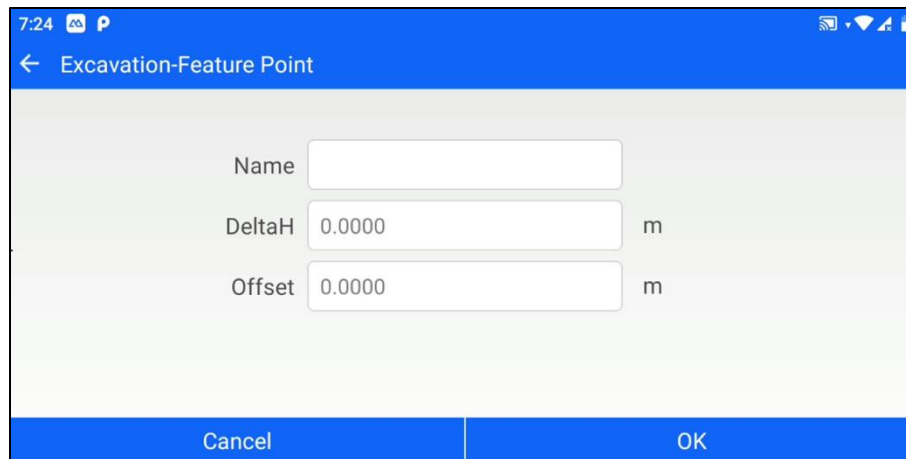
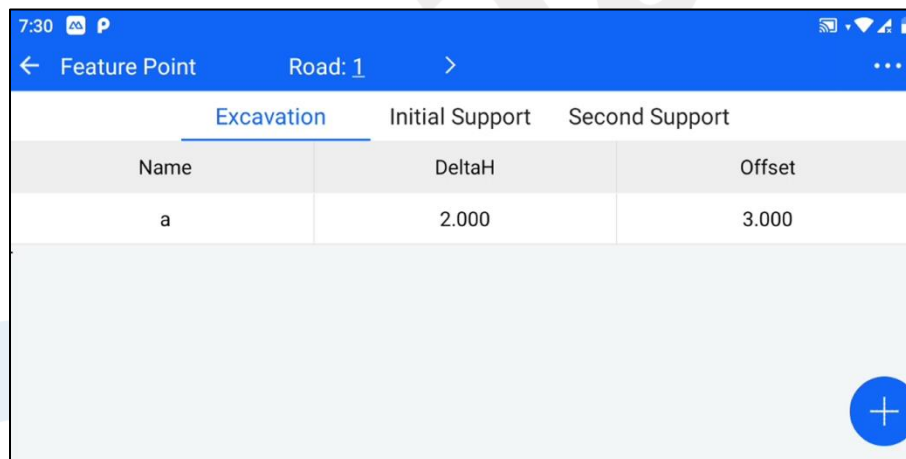

Figure 13-12

The process and method of designing feature points are the same for different section types, and the parameters to be set are point name, elevation difference, and offset distance.

4. Click "Save" to complete the design of a tunnel feature point.



Excavation			Initial Support	Second Support
Name	DeltaH	Offset		
a	2.000	3.000		

Figure 13-13

Click a feature in the tunnel feature list to "delete"/"edit" the feature.

Click "... " -> "Clear" in the upper right corner to clear the list of tunnel feature points.

13.3 Tunnel Over-under-excavation

The tunnel over- and under-excavation module can measure the target point and then determine the over-/under-excavation type and value based on the currently selected cross-section. The steps for tunnel over- and under-excavation are as follows.

1. Pre-requisites: has been in the [Road] - [Road Design] module to design a road (including at least a

flat section), the road has been designed for different section types of tunnel cross-sections and tunnel feature points.

2. Select road data: click the "Road" button, jump to the road library, and click to select the road data that need to be put back into the sample interface.

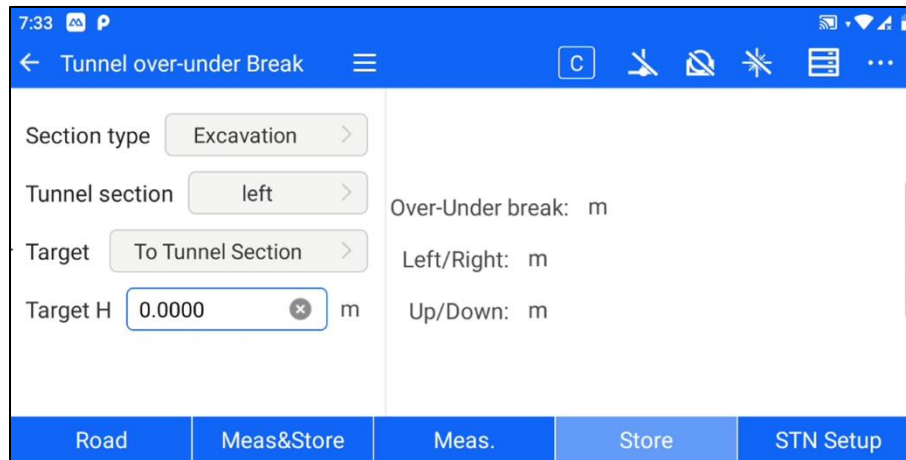

Figure 13-14

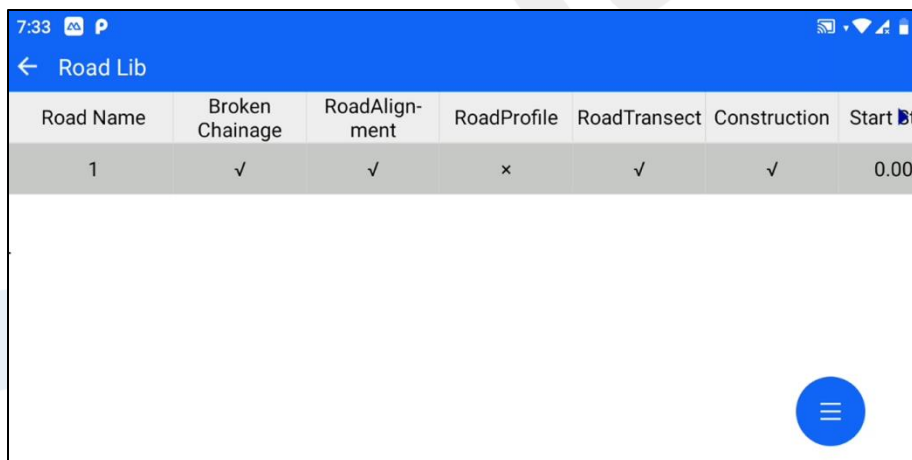

Figure 13-15

2. Target selection: After selecting the road data, click the section type column, tunnel section column, and target column, and select the current road data need to tunnel over and under the excavation section or feature points.

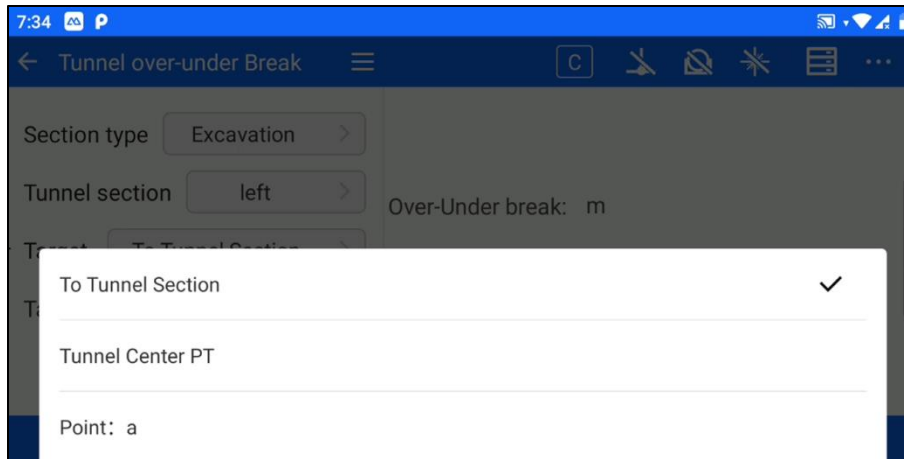

Figure 13-16

3. "To the section": If the target column selects the section, click on the measurement of storage/measurement, the right side will show the over-under excavation, left and right distance, and fill the distance.

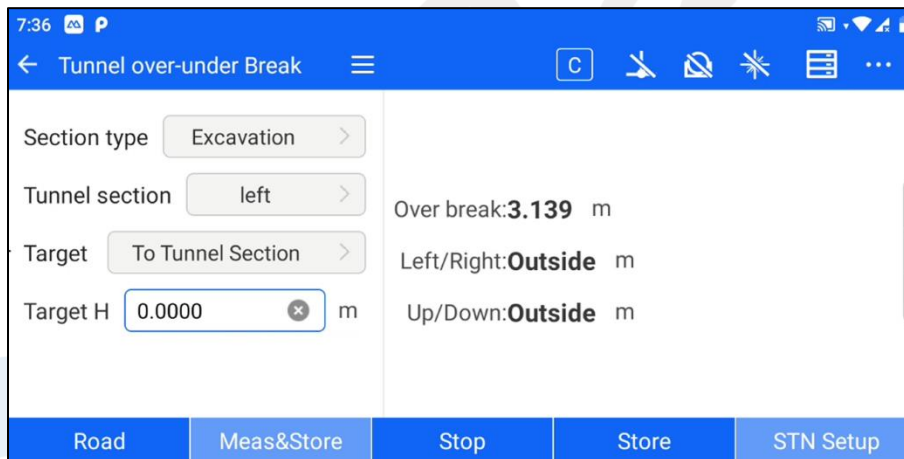

Figure 13-17

4. "To mid-tunnel point/feature point XX": If you select to mid-tunnel point or to feature point in the target column, click Save/Measure, the target angle and distance will be displayed on the right side, as well as the left/right distance, front/back distance and up/down distance.

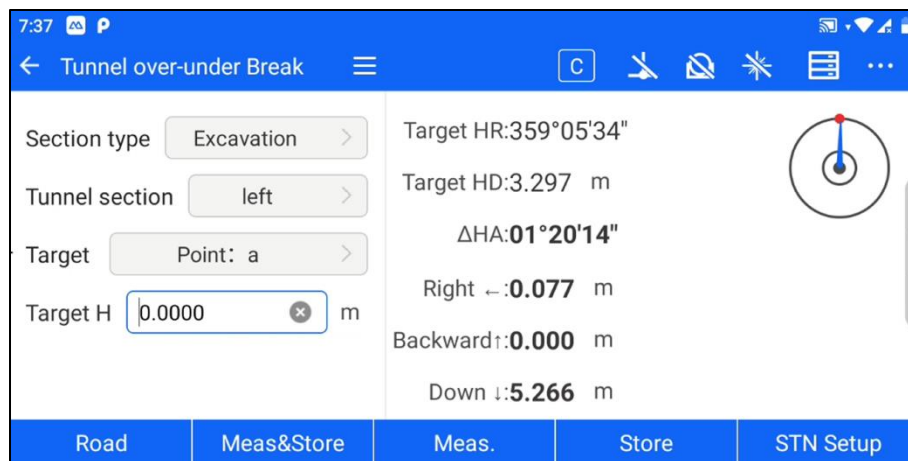

Figure 13-18

Chapter 14

Configuration

This chapter contains:

- Distance
- Other
- Meas. Auxiliary
- Unit & Display
- Calibration
- Info.



14.1 Distance

Users can click [Configuration] - [Distance] to enter this interface. Only the total station installation software can set this item, other Android devices do not display the [EDM Setting] item.

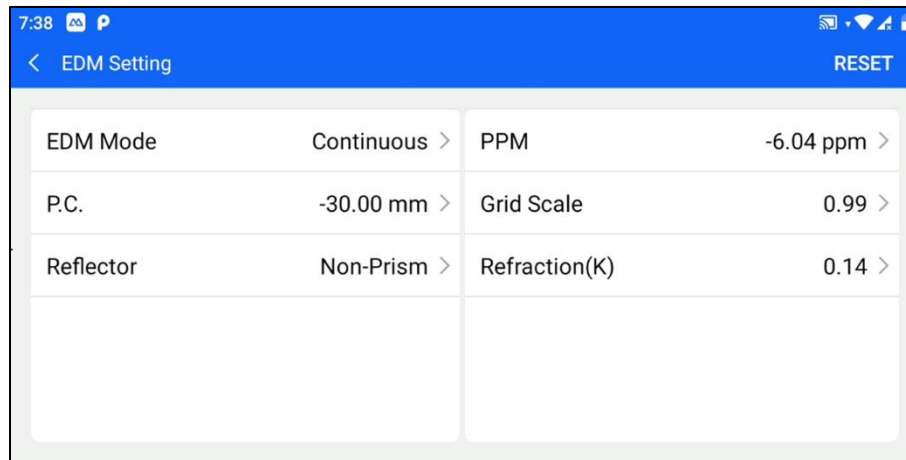

Figure 14-1

[Reset]: Click Reset in the upper right corner to reset the current interface parameters to the factory default values.

14.1.1 EDM Mode

The optional distance measurement modes are single precision measurement, multiple precision measurement (more than 0 times), continuous precision measurement, and tracking measurement. For continuous and tracking measurement, you need to click "Stop" to stop the measurement.

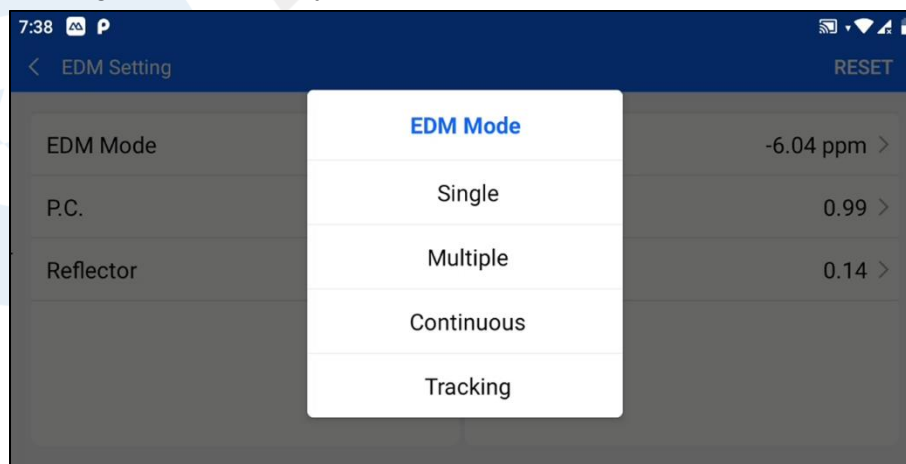

Figure 14-2

14.1.2 Prism Constant

Manually enter the prism constant.

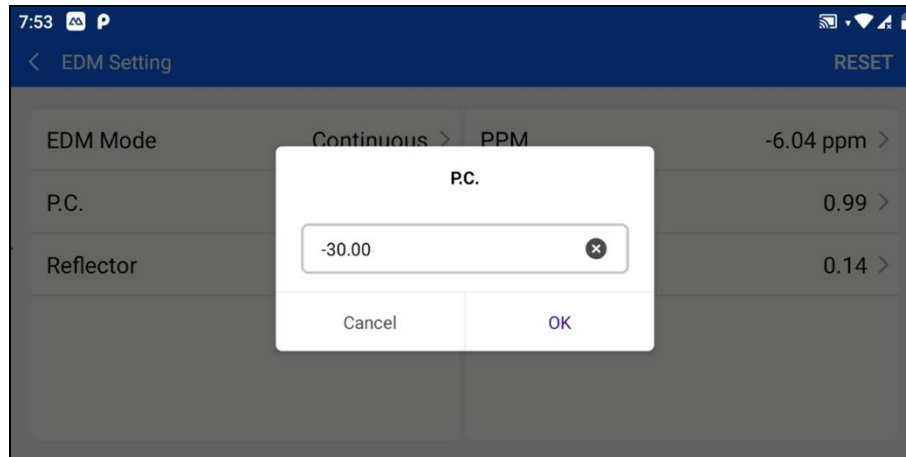

Figure 14-3

14.1.3 Reflector

The available reflectors are Non-prism, Prism, and sheet (reflective sheet). It is important to note that the selected reflector needs to be consistent with the actual reflector, otherwise, it may affect the accuracy or measurement failure.

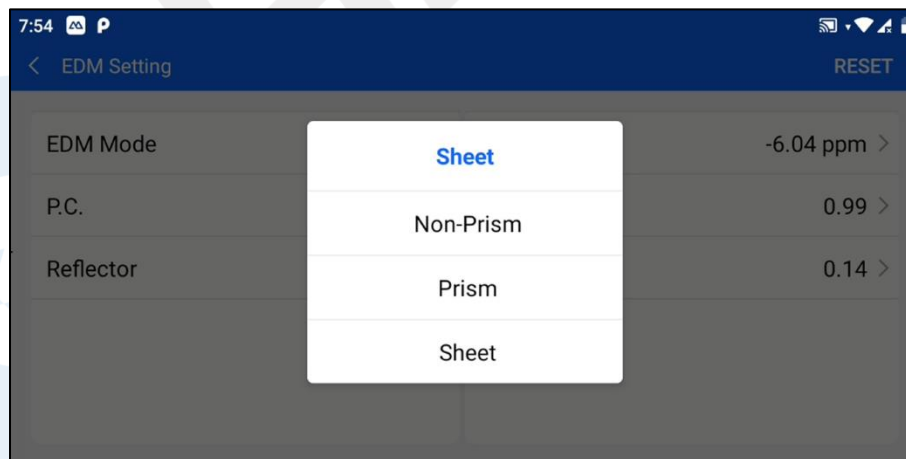

Figure 14-4

14.1.4 PPM (Atmospheric correction)

Atmospheric corrections can be calculated by temperature and pressure or set directly by dragging.

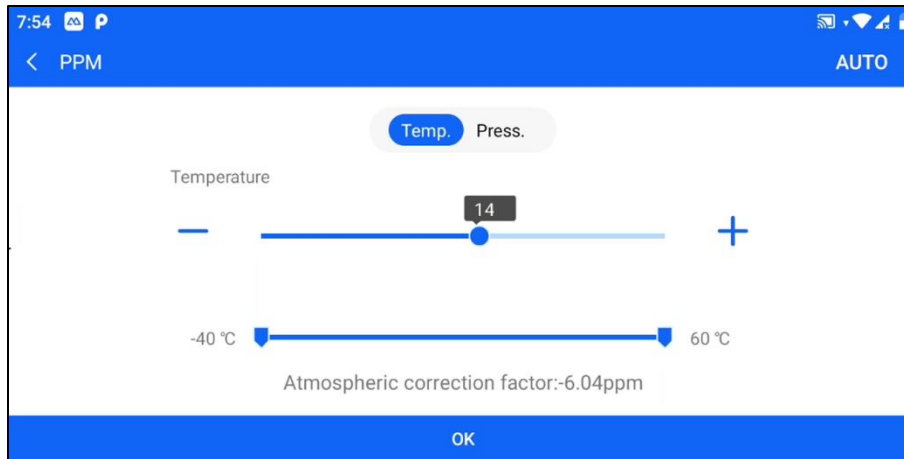

Figure 14-5

Automatic acquisition: The temperature and air pressure values in the current environment are automatically measured by the internal sensors of the total station.

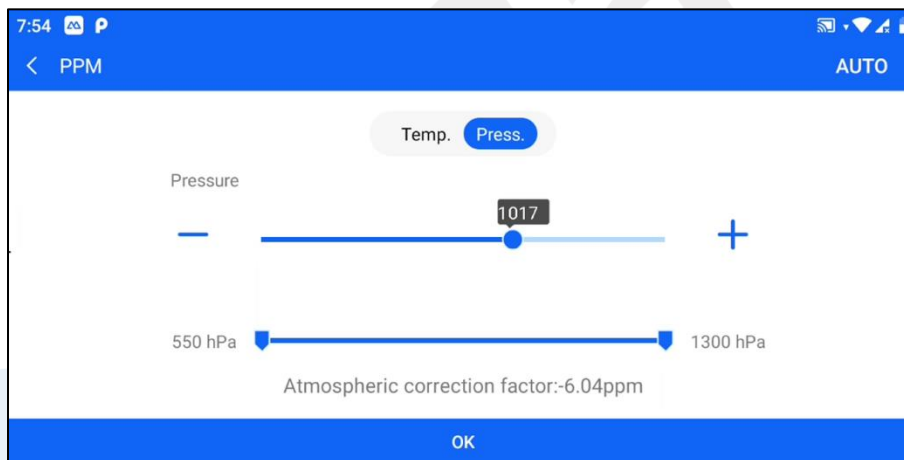

Figure 14-6

14.1.5 Grid Factor

The default grid factor is 1, which can be obtained by a scale factor and average elevation calculation.

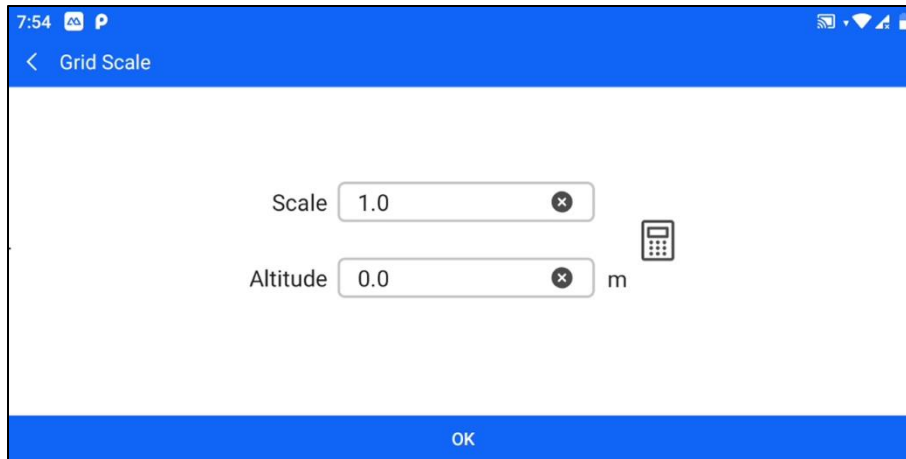



Figure 14-7

 : The grid factor was calculated based on the scale factor and the average elevation.

14.1.6 Atmospheric Refraction Coefficient

The optional atmospheric refraction coefficients are 0.0, 0.14, and 0.20.

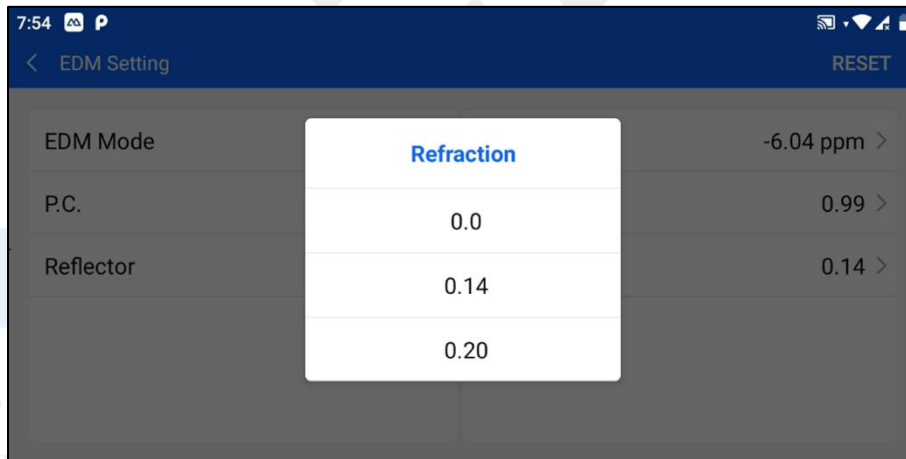

Figure 14-8

14.2 Other

Users can click [Configuration] - [Other] to enter this interface. Only the total station installation software can set this, other Android devices do not show the [Setting] item.

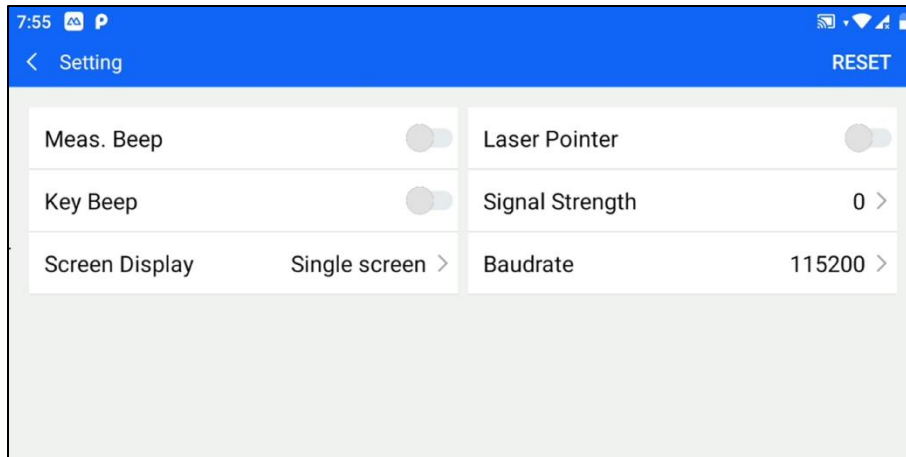

Figure 14-9

[Reset]: Click Reset in the upper right corner to reset the current interface parameters to the factory default values.

14.2.1 Distance Measurement Beep

Turn on this option and the total station makes an audible alert when the measurement is successful.

14.2.2 Key Tone

Turn on this option and the physical keys of the total station turn on the key tone.

14.2.3 Screen Display

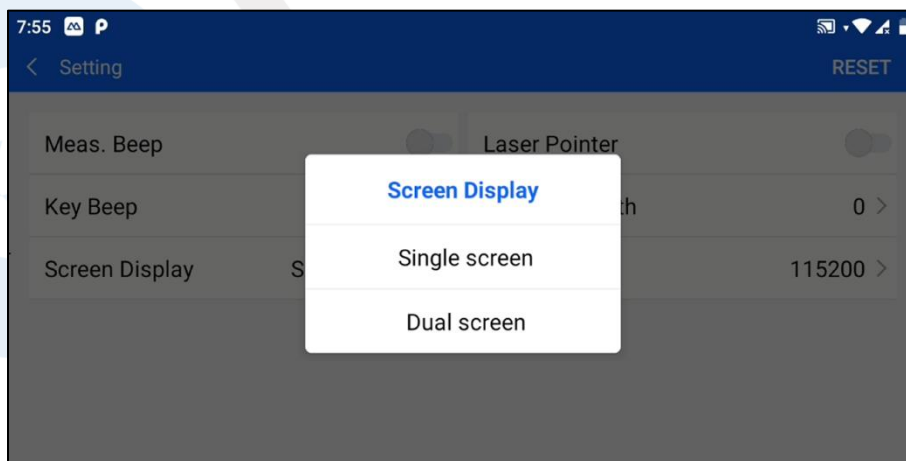

Figure 14-10

"Single screen ": the screen on one side of the operation is on, and the screen on the other side is off.

"Double screen ": both screens remain always on at the same time.

14.2.4 Laser Pointing

Turn on this option to shoot laser-assisted illumination.

14.2.5 Signal Strength

Click this option to detect the current signal strength once in real-time.

14.2.6 Baud Rate

Support 115200.

14.3 Meas. Auxiliary

Users can click [Configuration] - [Meas. Auxiliary] to enter this interface.

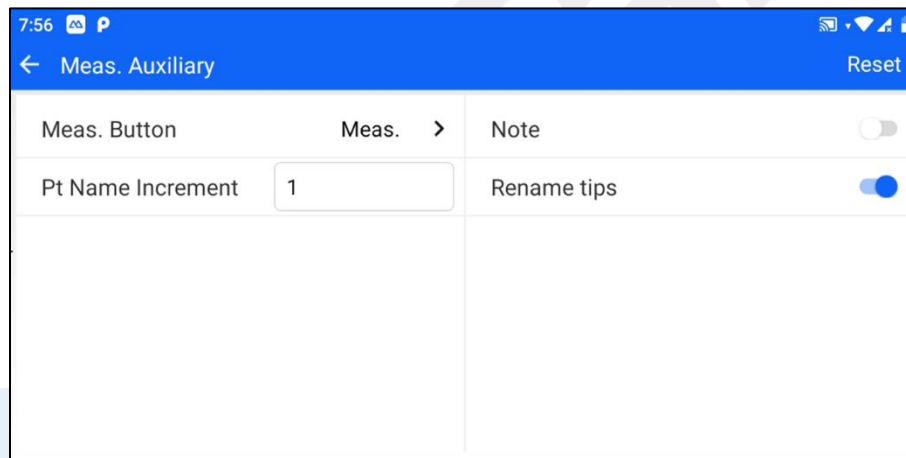

Figure 14-11

The full configuration is displayed when the total station is installed.

Other Android devices show partial configuration when installed.

[Reset]: Click Reset in the upper right corner to reset the parameters of the current interface to the factory default values.

14.3.1 Shortcut Meas. Key

There is a red Shortcut measurement key (physical key) on the side of the total station. This configuration allows you to set whether the Shortcut measurement key, when pressed, will perform a measurement operation or a measurement and storage operation.

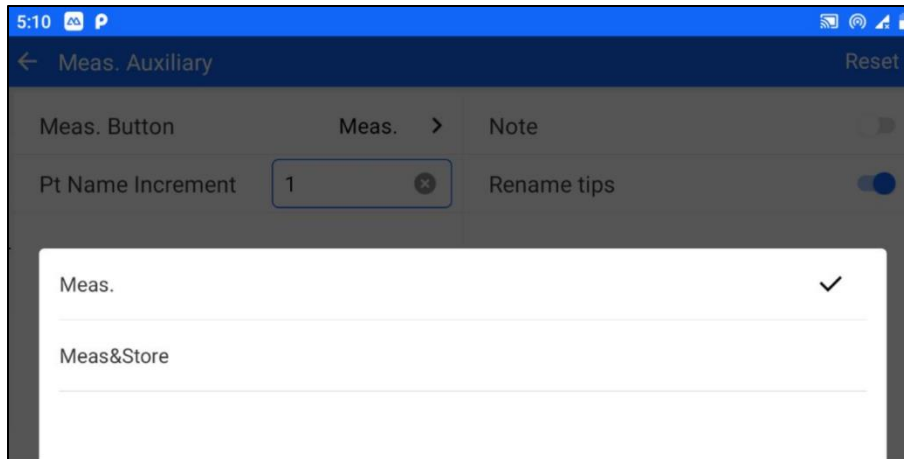

Figure 14-12

14.3.2 Pt Name Increment

Each time a measurement point is saved, the point number is self-incremented, and this configuration is used to set the step of point number self-increment.

14.3.3 Note

When you open this item, you can save the measurement point during coordinate measurement, and save the photo of the point at the same time. And you can view it in the measurement point library.

14.3.4 Rename tips

Open this item and it cannot save the rename point.

14.4 Unit & Display

Users can click [Configuration] - [Unit & Display] to enter this interface.

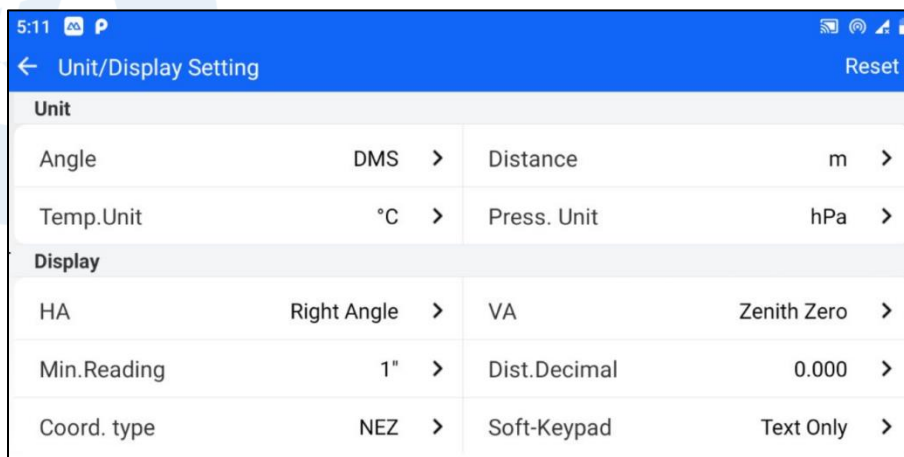

Figure 14-13

The full configuration is displayed when the total station is installed.

Other Android devices show partial configuration when installed.

[Reset]: Click Reset in the upper right corner to reset the parameters to their default values.

14.4.1 Angle

Used to set the units of each angle input box and angle display value of the software.

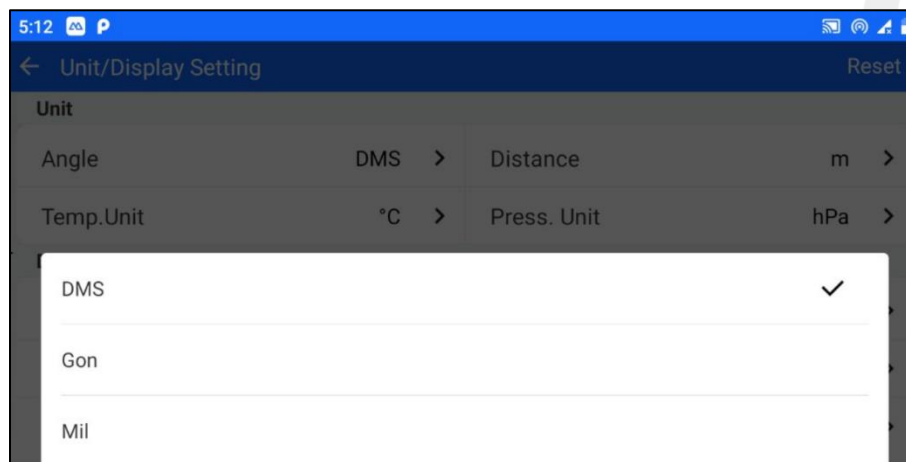
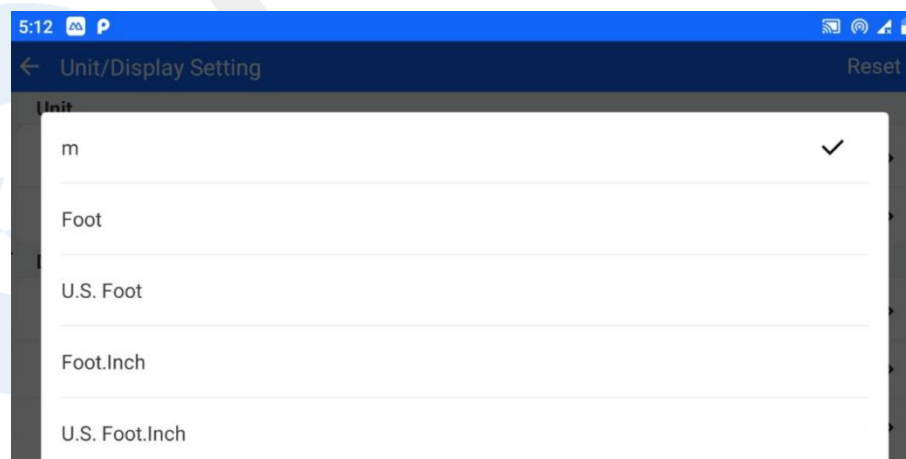

Figure 14-14

14.4.2 Distance

Used to set each length input box and distance display unit of the software.



14.4.3 Temperature Units

Used to set temperature units, mainly for atmospheric corrections.

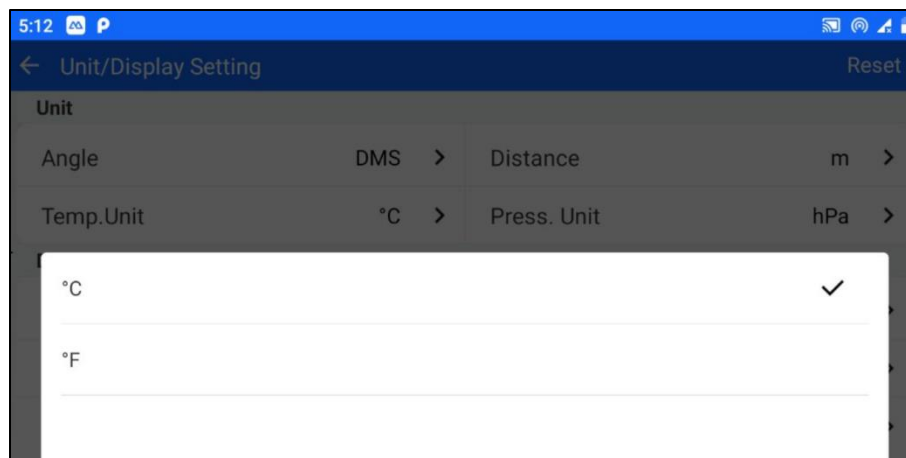

Figure 14-15

14.4.4 Pressure Unit

Used to set barometric pressure units, mainly for atmospheric correction.

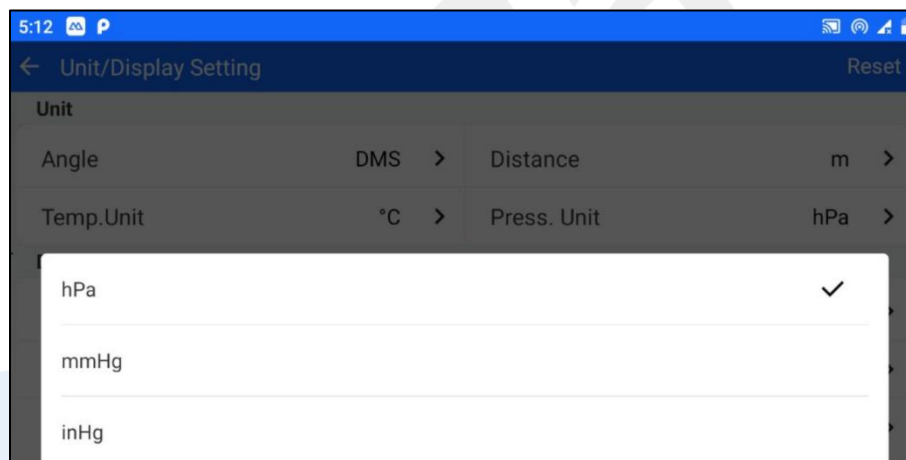

Figure 14-16

14.4.5 HA

Used to set the horizontal angle display of the measurement interface.

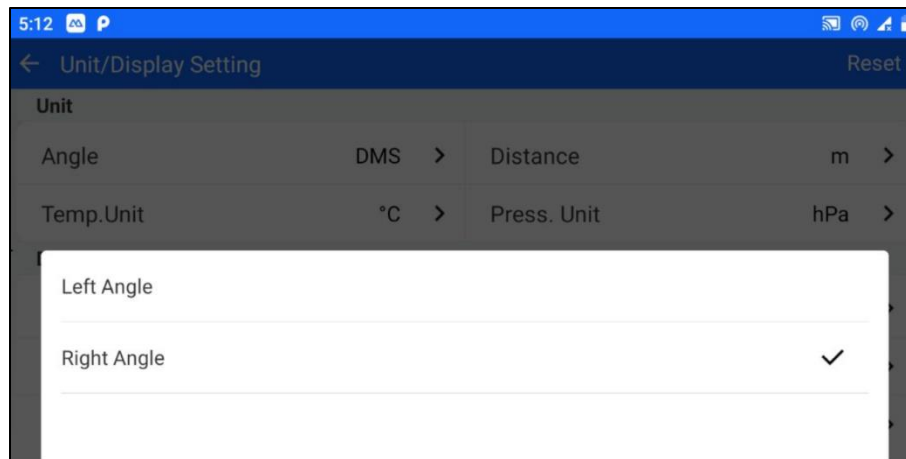

Figure 14-17

14.4.6 VA

Used to set the vertical angle display of the measurement interface.

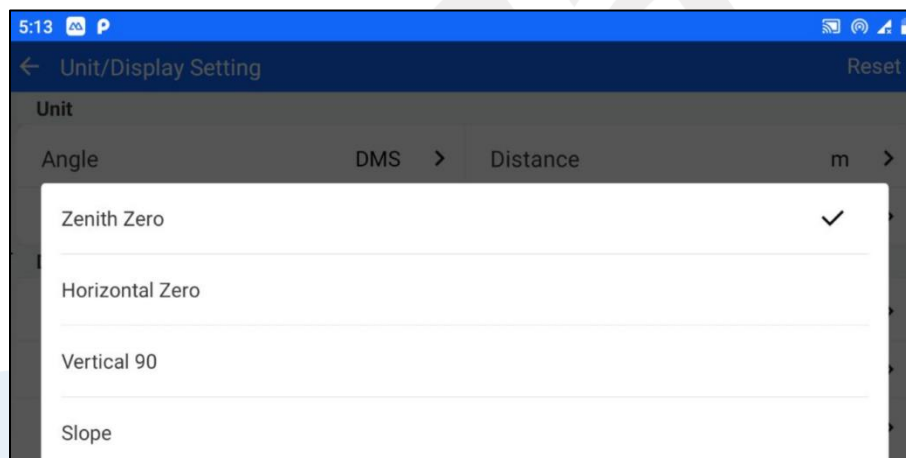

Figure 14-18

14.4.7 Min. Reading

Used to set the accuracy of the angle display of the measurement interface.

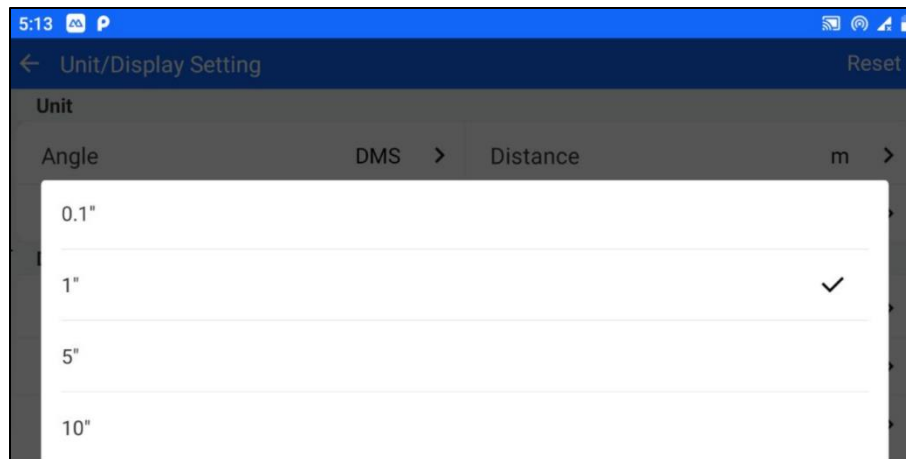

Figure 14-19

14.4.8 Distance Decimal

Used to set the accuracy of the distance display of the measurement interface.

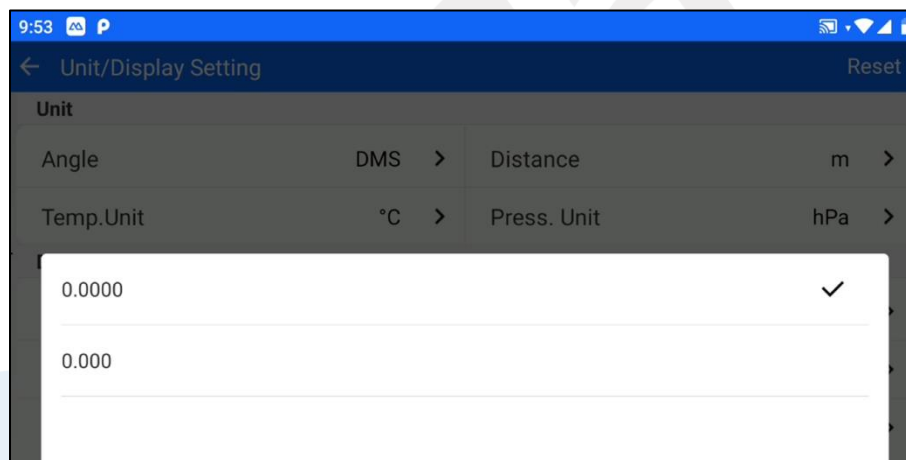

Figure 14-20

14.4.9 Coord. type

Used to set the interface NEZ display order.

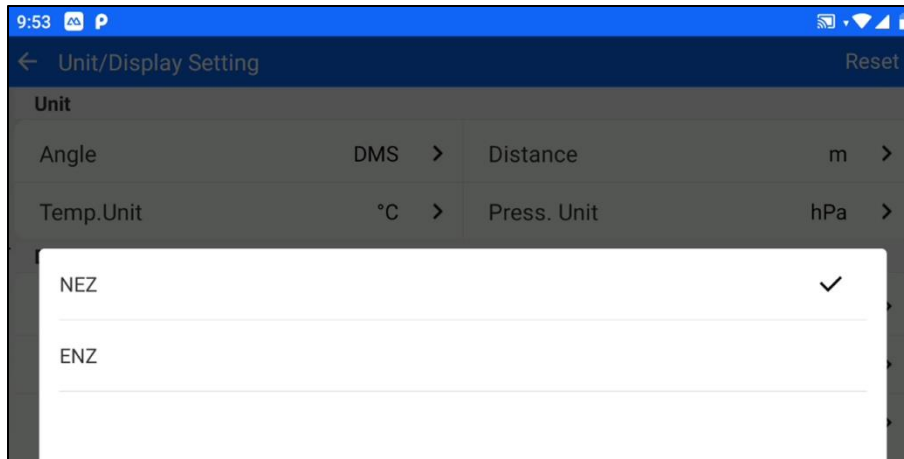

Figure 14-21

14.4.10 Soft-Keypad

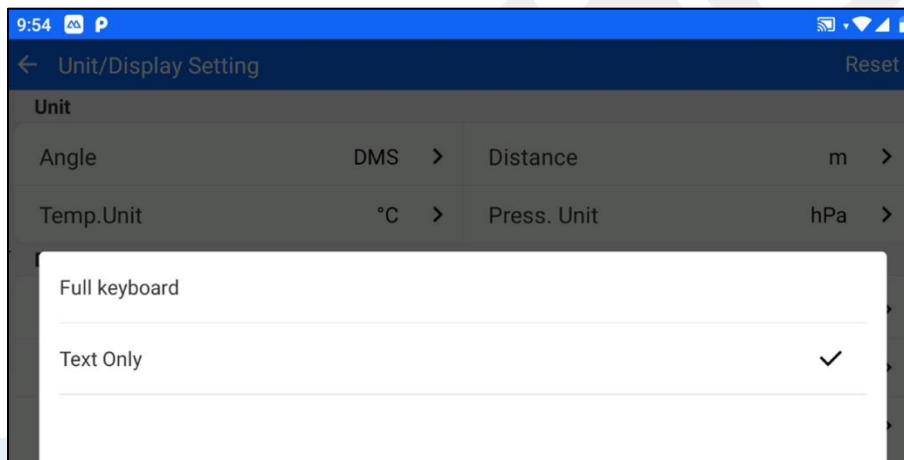

Figure 14-22

"Full keyboard": soft keyboard will pop up when either a numeric or text input box is selected.

"Text input only": soft keyboard pops up when only the text input box is selected.

14.5 Calibration

Total station calibration is generally used to calibrate the parameters of the total station, password: 12345678, when you need to correct it, please contact the service provider for calibration.

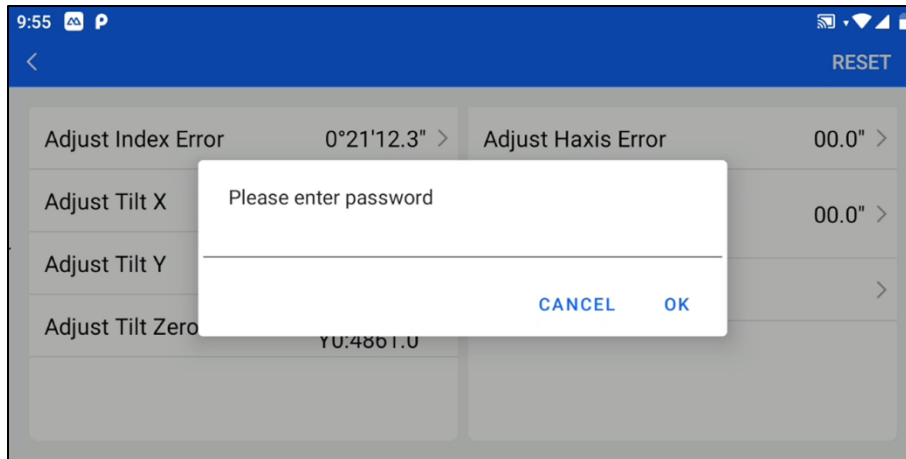

Figure 14-23

14.6 Info.

When installed on a total station, the total station information displays the total station number, range and angle module version, service version, and registration time.

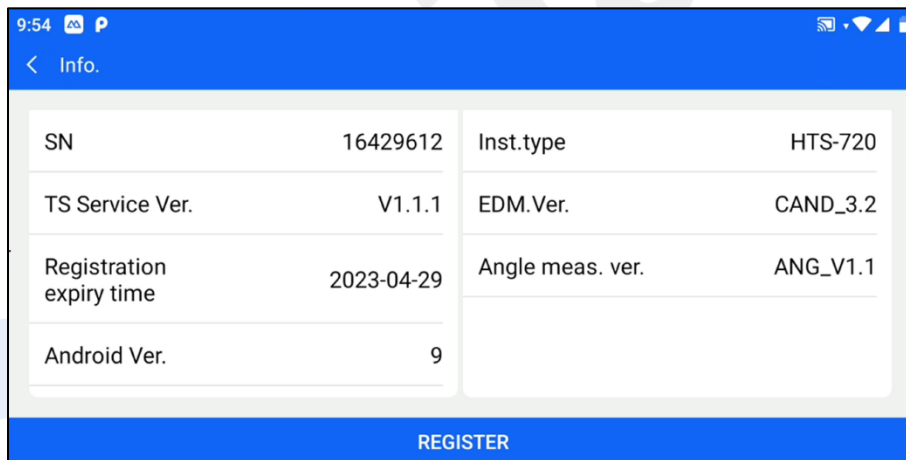

Figure 14-24

Click the "Register" button at the bottom to register your Total Station hardware.

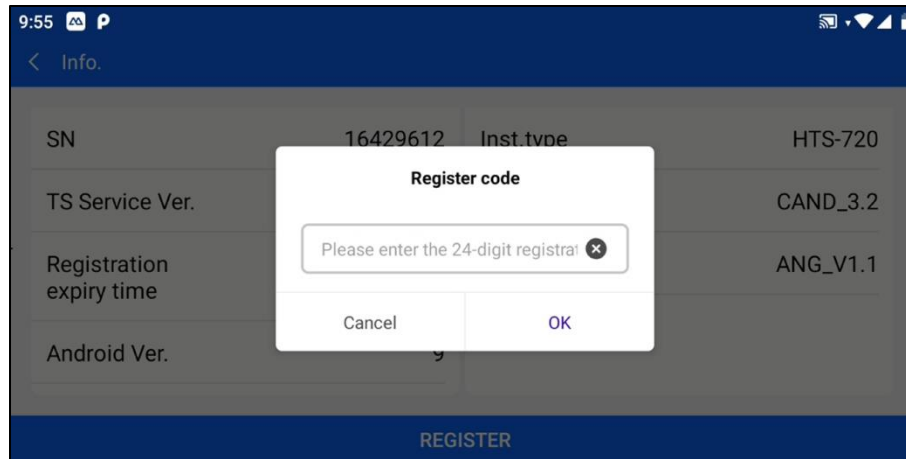

Figure 14-25

When installed on other Android devices, the total station information can be used to connect to the device in "demo mode" and "Wifi".

"Demo mode": Use demo mode to connect the total station and the software displays simulated range and angle information. It can be used for demonstration.

"Wifi connection": the total station needs to open the hotspot first, after the Android device connects to the total station hotspot, select the connection method as "Wifi", and follow the guide to complete the total station connection. After the connection is completed, the basic information of the connected total station will be displayed.

Chapter 15

Quick Menu

This chapter contains:

- Laser Plummet
- Atmospheric Correction
- Prism Constant
- Reticle Backlight
- Function Key
- FTP
- Register TS



Hi-Target

The shortcut menu can be opened by clicking on the top bar , which is the left-side slider bar. The full configuration is displayed when installed on the Total Station, the partial configuration is displayed on other Android devices.

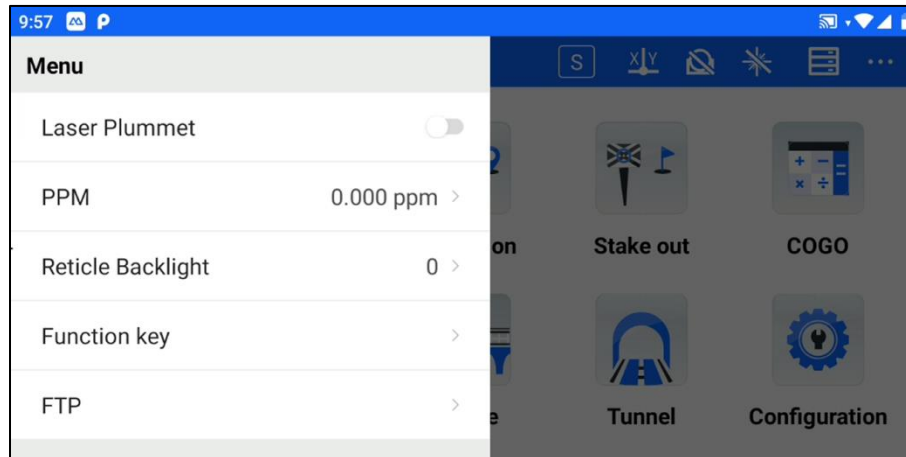

Figure 15-1

15.1 Laser Plummet

Turn on the Laser Plummet, the laser shoots out from the bottom of the total station for easy alignment.

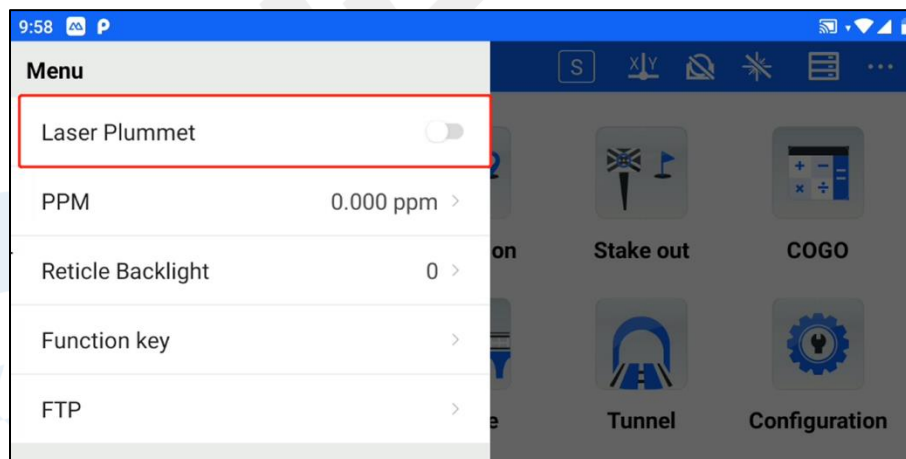

Figure 15-2

15.2 PPM

PPM (atmospheric correction) can be calculated by temperature and pressure or input directly. The setting here has the same effect as the setting in [EDM Setting].

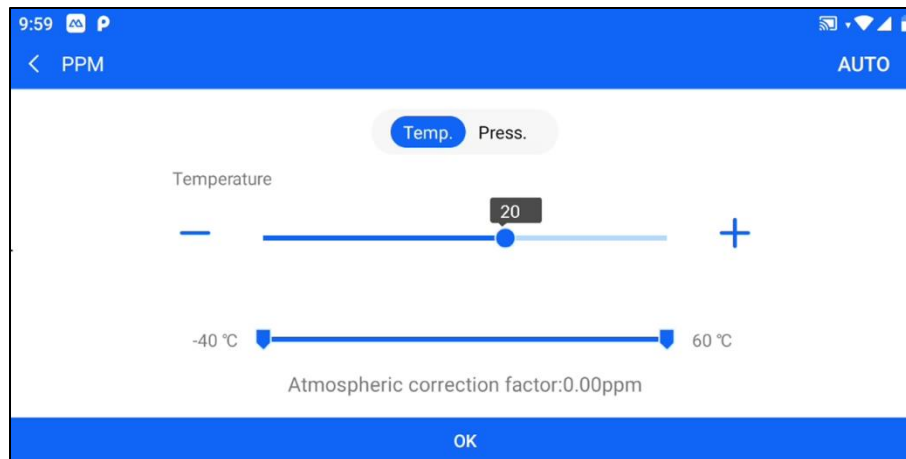

Figure 15-3

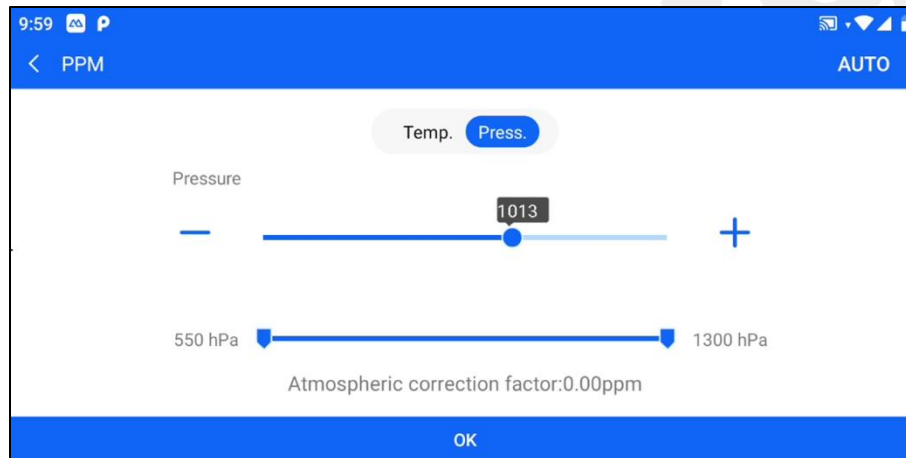

Figure 15-4

15.3 Prism Constant

The prism constant of the prism can be set. The setting here has the same effect as the setting in [EDM Setting].

15.4 Reticle Backlight

Set the illumination level of the scoreboard for illumination during nighttime measurements.

15.5 Function Key

Used to set the shortcut jump parameters of the physical keys of the total station, the specific settable parameters are shown below.

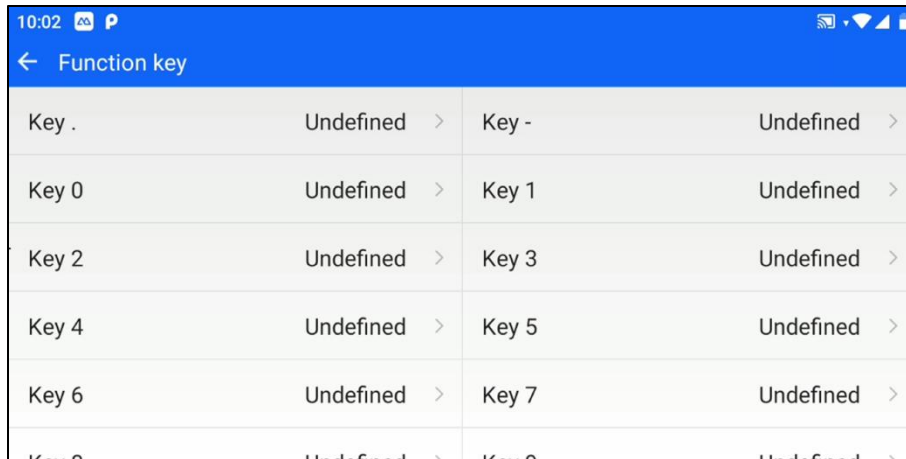

Figure 15-5

15.6 FTP

Used for FTP transfer parameters, and can be used for file transfer. By default, the software does not check "Transfer without encryption", users need to enter their user name, password, and port. If "Transfer without encryption" is checked, the software does not display the user name and password input box, and the user only needs to configure the port. When the device is connected to Wifi, the software will automatically fill in the IP parameters and the port number will be 2121 by default; after the user has configured all the parameters, click [Start], the user will follow the prompts on the software and enter the corresponding path on the address bar of the computer to download the FTP transfer files.

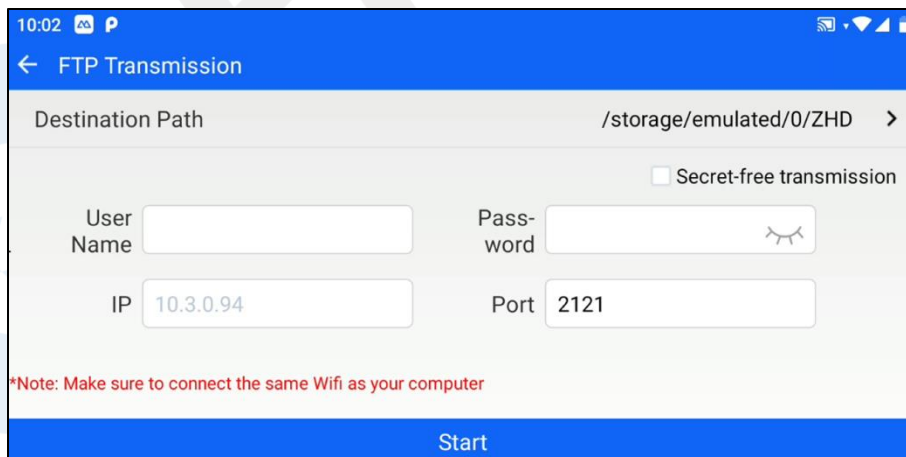

Figure 15-6

15.7 Register TS

Register TS can enter the interface of total station information and perform registration operation, which is consistent with the function of configuration-total station information; the cell phone terminal shows total station connection/registration, which can quickly enter the connection interface and perform registration operation after connection, which is consistent with the function of total station information.

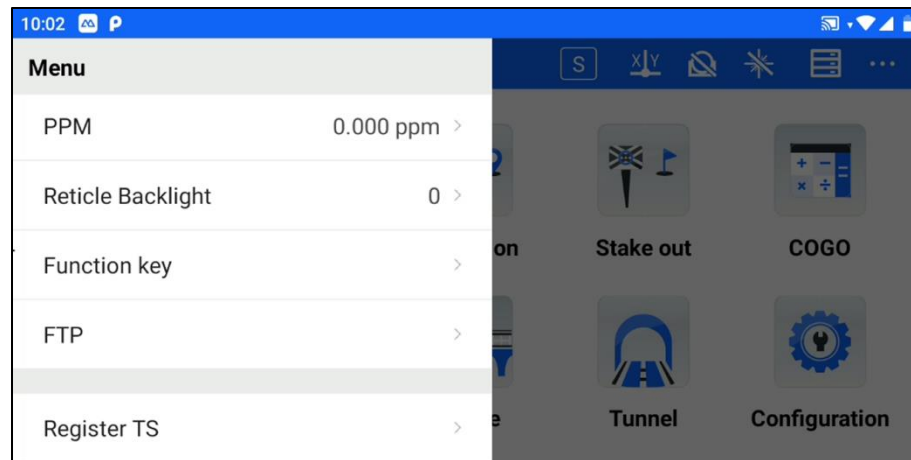

Figure 15-7

Chapter 16

Top Shortcut Function

This chapter contains:

- Dist Mode(distance measurement)
- Tilt Compensation
- Reflector Type Switching
- Laser Pointing
- Point Data
- More



16.1 Dist Mode(distance measurement)

Click on the top bar  to set the Dist Mode(distance measurement), and you can set the mode as follows. The setting here has the same effect as the setting in [EDM Setting].

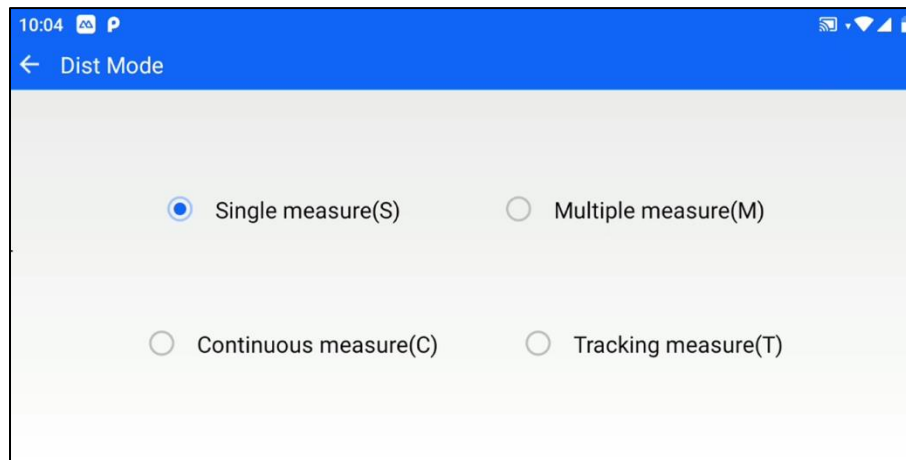

Figure 16-1

16.2 Tilt Compensation



Click the top bar  to compensate and correct the Angle reading error caused by the tilt of the vertical axis of the instrument in X and Y directions. The compensation settings supported by the software are: turn on XY dual-axis compensation, turn on X single-axis compensation, and turn off compensation.



Figure 16-2

Users can choose whether to turn on the tilt compensation according to the actual use scenario. To ensure the accuracy of the angle measurement, it is generally recommended to use the tilt sensor as much as possible, and its display can also be used to better level the instrument. If "compensation exceeded", it indicates that the instrument is out of the range of automatic compensation and must be adjusted to level the foot spiral.

16.3 Reflector Type Switching

Click the top bar  to switch the reflector type to Prism, Non-prism, or Reflector. This setting has the same effect as the setting in [EDM Setting].

16.4 Laser Pointing

Click the top bar  to turn the objective-pointing laser on or off. This setting has the same effect as the setting in [EDM Setting].

16.5 Point Data

Click the top bar  to enter the point library to view the measurement points, stakeout points, and control points.

16.6 More

Click on the top bar  to expand the menus as shown below.

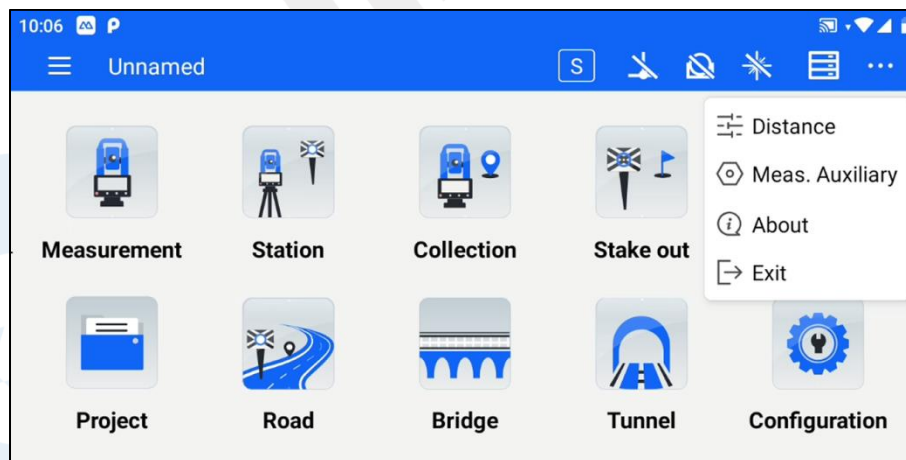

Figure 16-3

16.6.1 Distance

For the shortcut entrance of [EDM Setting], see Chapter 10 [Configuration] for specific functions.

16.6.2 Meas. Auxiliary

For the shortcut entrance of [Meas. Auxiliary], see Chapter 14 [Configuration] for specific functions.

16.6.3 About

Displays the software version and updates information.

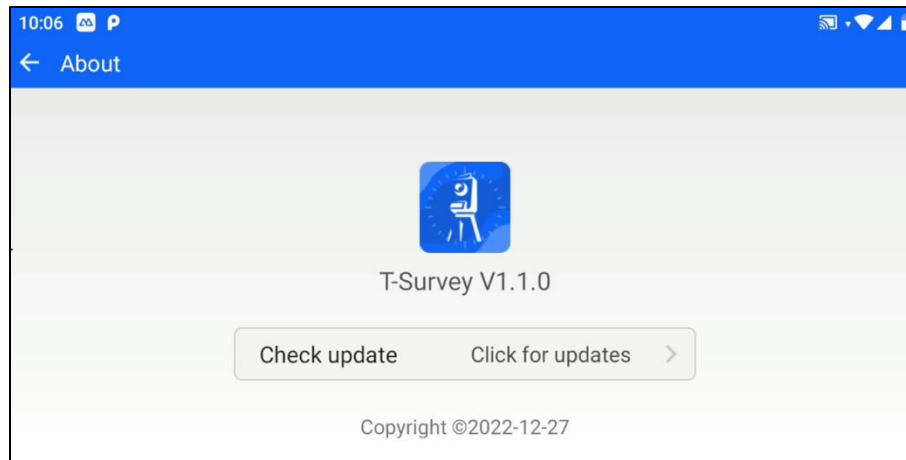

Figure 16-4

16.6.4 Exit

Click this item to bring up the exit confirmation box, which can be used to exit the software.

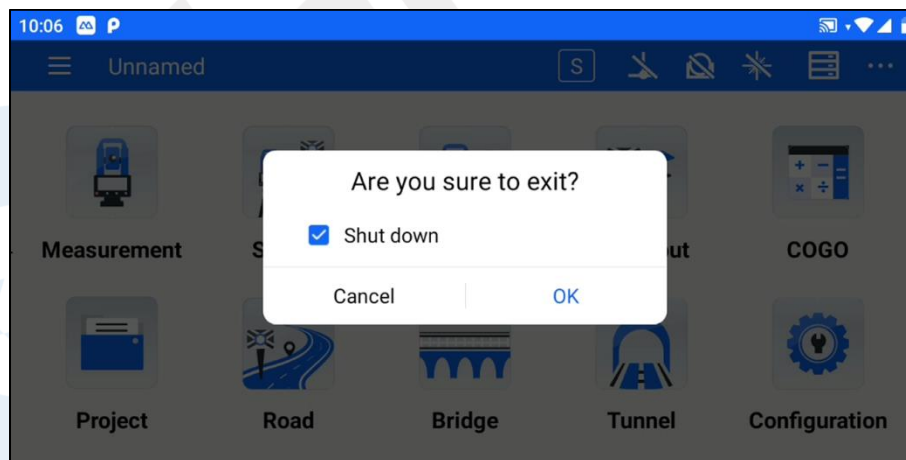

Figure 16-5

Chapter 17

Inspection and Calibration

This chapter contains:

- Tube Level
- Round Level
- Telescope Reticle
- Perpendicularity of the Visualization Axis to the Horizontal Axis
- Automatic Compensation of Zero Point of Vertical Disc Indicator
- Vertical Index Spread and Vertical Index Zero Setting
- Vertical Index Difference (i-angle) and Vertical Index Zero Point Setting
- Laser Plummet
- Instrument Addition Constants (K)
- The parallelism between the Alignment Axis and the Emitting Electro-optical Axis
- Non-prism Distance Measurement

17.1 Tube Level

17.1.1 Check

The method is described in the book "Accurate leveling instruments with tube level".

17.1.2 Adjust

1. In the inspection, if the bubble of the tube level deviates from the center, first use the foot spiral parallel to the tube level to adjust it, so that the bubble moves to the center nearly half of the deviation amount. The remaining half of the bubble will be adjusted by turning the level correction screw (on the right side of the level) with the correction needle until the bubble is centered.

2. Rotate the instrument 180° and check whether the bubbles are centered. If the bubble is still not centered, repeat step 1 until the bubble is centered.

3. The instrument will be rotated 90 °, with the third foot screw to adjust the bubble centered.

- Repeat the test and calibration steps until the alignment section is turned so that the bubble is centered in any direction.

17.2 Round Level

17.2.1 Check

After the long level is checked and calibrated correctly, if the bubble of the round level is also centered, there is no need to correct it.

17.2.2 Adjust

If the bubble is not centered, adjust the calibration screws below the bubble with a calibration pin or hexagonal hand to center the bubble. When correcting, loosen the correction screws (1 or 2) on the opposite side of the bubble offset direction, and then tighten the remaining correction screws on the offset direction to center the bubble. When the bubble is centered, the tightening force of all three calibration screws should be the same.

17.3 Telescope Reticle

17.3.1 Check

1. After leveling the instrument, select a target point A on the telescope line of sight, align A with the center of the cross wire of the dividing board, and fix the horizontal and vertical brake hand wheel.
2. Turn the vertical micro-hand wheel of the telescope so that point A moves to the edge of the field of view (point A').
3. If the A point is moving along the vertical wire of the cross wire, that is, the A' point is still within the vertical wire, as in the left figure, the cross wire is not tilted without correction. If the A' point deviates from the center of the vertical wire, as in the right figure, the cross wire is tilted and needs to be corrected for the dividing plate.

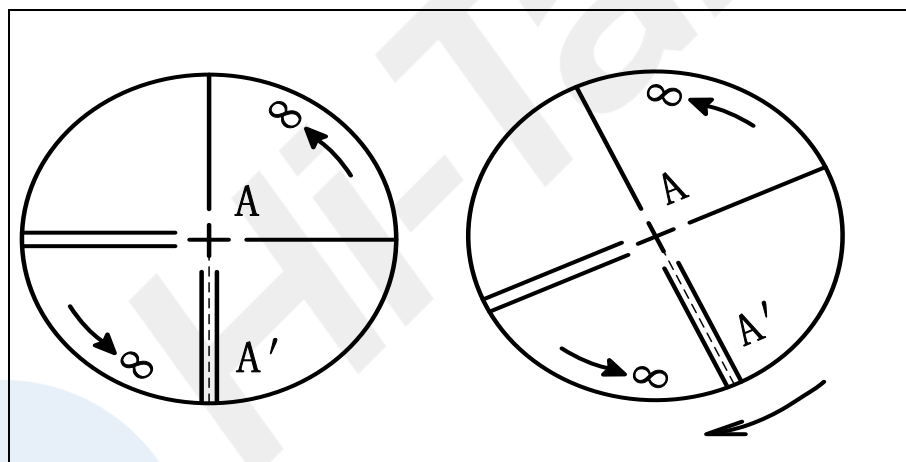

Figure 17-1

17.3.2 Adjust

1. First of all, remove the cover of the dividing plate holder located between the telescope eyepiece and the focus handwheel, you will see four dividing plate holders fixed

Screws (see attached picture)

2. Use a screwdriver to evenly loosen the three set screws, and rotate the dividing plate seat around the sight axis so that the A' point falls on the position of the vertical wire.

3. Tighten the fixing screws evenly, and then check the calibration result by the above method.
4. Install the cover back to its original position.

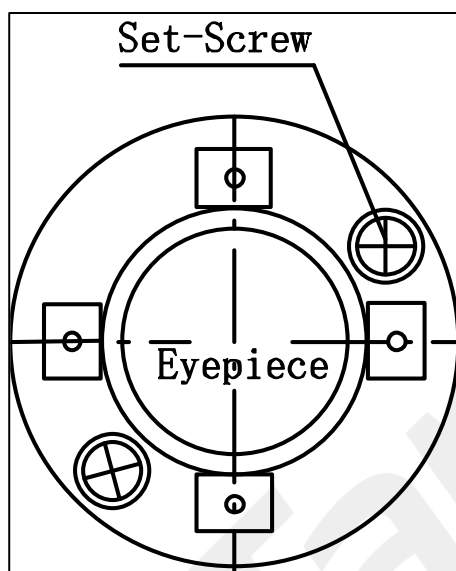

Figure 17-2

17.4 Perpendicularity of the Visualization Axis to the Horizontal Axis

17.4.1 Check

1. Set target A at a distance of about 100 meters from the instrument and make the vertical angle of the target within $\pm 3^\circ$. Accurately level the instrument and turn on the power.
2. Aim the telescope at target A in the left position of the disk and read the horizontal angle.

Example: Horizontal angle $L = 10^\circ 13' 10''$

3. Loosen the vertical and horizontal hand wheels, rotate the telescope, and rotate the right side of the illumination plate to Aim at the same target A. Before illumination, tighten the horizontal and vertical hand wheels, and read the horizontal angle.

Example: Horizontal angle R= 190°13'40"

4. $2C=L-(R\pm 180^\circ)=-30''\geq\pm 20''$, need to be corrected.

17.4.2 Adjust

1. Adjust the horizontal angle reading with the horizontal micro hand wheel to the correct reading after eliminating C.

$$R + C = 190^\circ 13' 40'' - 15'' = 190^\circ 13' 25''.$$

2. Remove the shield of the dividing board located between the telescope eyepiece and the focusing handwheel, adjust the horizontal cross-wire correction screws on the dividing board, loosen the screws on one side first, and then tighten the screws on the other side, move the dividing board so that the center of the cross-wire is aligned with the target A.

3. Repeat the test program, and correct until $| 2C | < 10''$ meets the requirements.

4. Tighten the calibration screw and install the cover back to the original position.

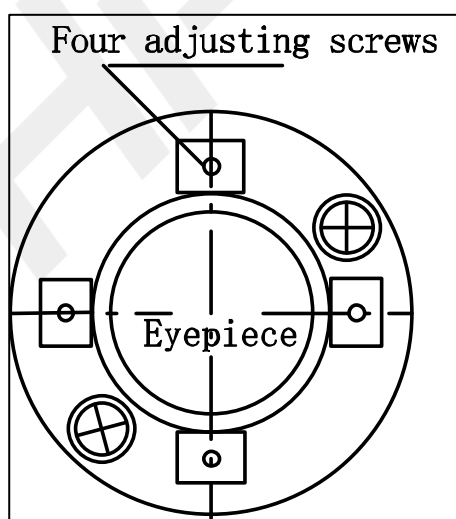

Figure 17-3

Note: The photoelectric coaxially should be checked after calibration.

17.5 Vertical Index Spread and Vertical Index Zero Setting

17.5.1 Check

1. After placing and leveling the instrument, make the pointing of the telescope and the center of the instrument consistent with the joint line of either foot spiral X. Screw the horizontal brake hand wheel.
2. After the power is turned on, the vertical disk indicator is zeroed, the vertical hand wheel is tightened, and the instrument displays the value of the current vertical angle at which the telescope points.
3. Slowly turn the foot spiral X in one direction to about 10mm circumferential distance, the vertical angle displayed by the corresponding change to the disappearance of the "compensation beyond!" message, indicating that the instrument vertical axis tilt has been greater than 3', beyond the design range of the vertical disk compensator. When the reverse rotation of the foot spiral recovery, the instrument and reappear vertical angle, in the critical position can be repeatedly tested to see its change, that the vertical disk compensator work properly.

17.5.2 Adjust

When the instrument compensation is found to be out of order or abnormal, it should be sent to the factory for repair.

17.6 Vertical Index Difference (i-angle) and Vertical Index Zero

Point Setting

17.6.1 Check

1. After placing and leveling the instrument, turn on the machine, shine the telescope on any clear target A, and get the vertical angle disk left reading L.
2. Turn the telescope and the illumination part and then aim at A to get the right reading of the vertical angle disk R.
3. If the vertical angle zenith is 0° , then $i = (L + R - 360^\circ) / 2$, if the vertical angle

horizontal is 0.

Then $i = (L + R - 180^\circ)/2$ or $(L + R - 540^\circ)/2$.

4. If $|I| \geq 10''$, the zero point of the vertical disk indicator should be reset.

5. The operation method is as follows.

(1) Install the total station to the calibration table, level it, click "Calibration", enter the password (please contact your local dealer to get it), and then enter the calibration interface.

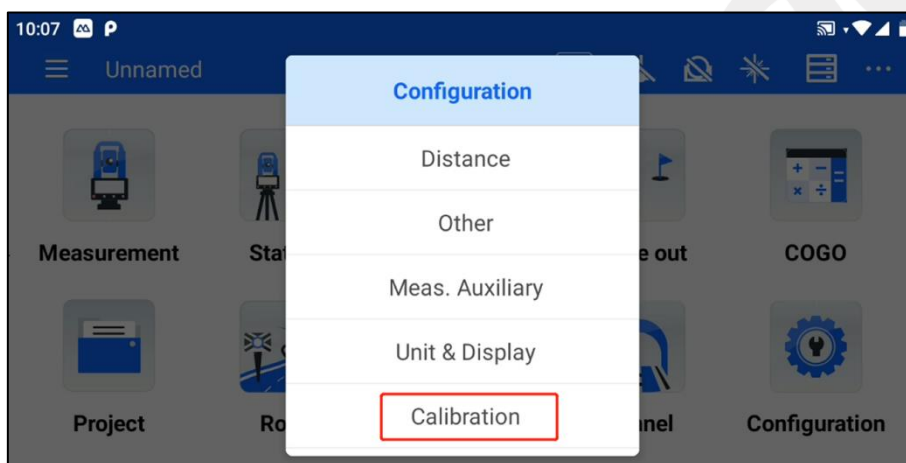

Figure 17-4

(2) Select the parameter item to be calibrated and enter the corresponding calibration interface.

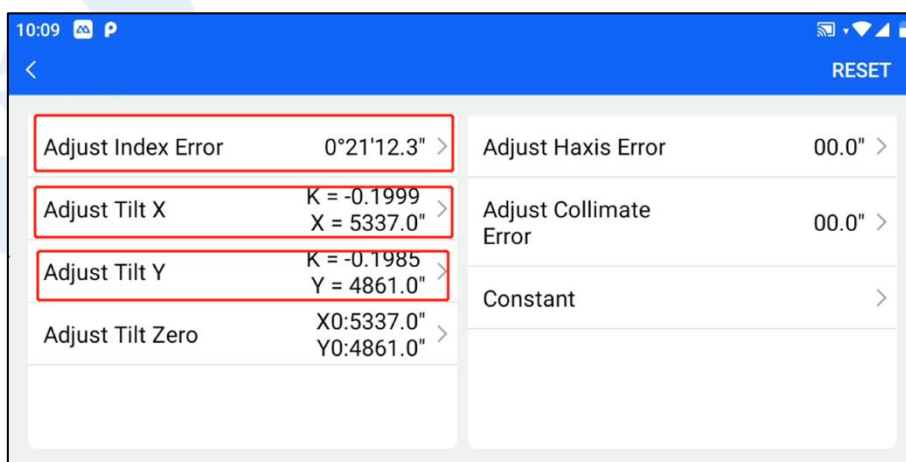

Figure 17-5

(3) Follow the instructions at the bottom of the interface until the calibration is finally completed.



Figure 17-6



Note: 1. Repeat the test steps to re-measure the indicator difference (i angle). If the indicator difference still does not meet the requirements, you should check whether the step operation of the correction ***indicator zero setting*** (the vertical angle shown in the zero setting process is the value without compensation and correction, only for reference in the setting and not for other purposes) is wrong, and whether the target illumination is accurate, etc., and then set it again as required.

6. After repeated operations still does not meet the requirements, should be sent to the factory for maintenance.

17.7 Laser Plummet

17.7.1 Check

1. Place the instrument on a tripod, draw a cross on a piece of white paper, and place it on the ground directly below the instrument.

2. After adjusting the focus of the aligner (for optical aligner) or opening the laser aligner, move the white paper so that the cross is located in the center of the field of view (or laser spot).
3. Turn the foot spiral so that the center mark of the aligner coincides with the crossover point.
4. Rotate the illumination part, every 90° , and observe the center mark of the alignment point and the overlap of the cross.
5. If the center mark of the optical aligner is always coincident with the cross when the alignment section is rotated, no correction is necessary. Otherwise, it should be corrected according to the following method.

17.7.2 Adjust

1. Remove the corrective screw cover between the optical aligner eyepiece and the focusing handwheel.
2. Fix the crossed white paper and mark on the paper the center mark the fall point of the aligner for every 90° rotation of the instrument, such as points A, B, C, and D in the figure.
3. Connect the diagonal points AC and BD with a straight line, and the intersection of the two lines is O.
4. Adjust the four alignment screws of the aligner with the alignment pin so that the center mark of the aligner coincides with the O point.

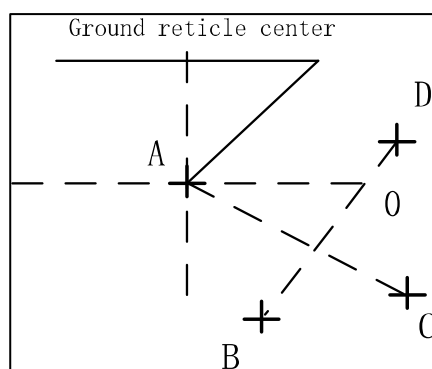

Figure 17-7

5. Repeat inspection step 4 and check the calibration until it meets the requirements.
6. For the laser under the point, then unscrew the laser cover, use 1 # hexagonal wrench to adjust the three screws, while tightening and loosening, and finally adjust the laser spot to 0 points.
7. Install the cover back to its original position.

17.8 Instrumentation Plus Constant (K)

The instrument constants are checked at the factory and corrected in the machine so that $K = 0$. The instrument constants rarely change, but we recommend that this test be performed once or twice a year. This test is suitable for the standard baseline, but can also be carried out according to the following simple method.

17.8.1 Check

1. Select a flat site at point A to place and level the apparatus, and use vertical wire to carefully mark the same line on the ground at an interval of about 50m between points A, B, and B, C, and accurately align the reflective prism.
2. After the instrument was set up with temperature and air pressure data, the flat distance of AB and AC was measured accurately.
3. Place the instrument at point B and align it accurately to measure the flat distance of BC precisely.
4. The instrument range constants can be derived as follows.

$$K = AC - (AB + BC)$$

K should be close to equal to 0, if $|K| > 5\text{mm}$ should be sent to the standard baseline field for strict inspection, and then corrected according to the inspection value.

17.8.2 Adjust

After strict inspection to confirm that the instrument constant K is not close to 0 has changed, the user, if required to make corrections, will set the instrument plus the

constant according to the value of the integrated constant K. For example, if the K value measured by the above method is -5, and the original instrument constant in the instrument is -20, the newly set value is $-20 - (-5) = -15$.

- The vertical wire of the instrument should be used for orientation, strictly so that the three points A, B, and C are in the same straight line. the ground at point B should have a firm and clear alignment mark.
- Whether the center of the prism at point B coincides with the center of the instrument is an important part of ensuring detection accuracy, therefore, it is best to use a tripod at point B and a base that can be used for both, such as a three-jaw prism connector and base interchange, the tripod and base remain fixed, and only change the prism and instrument above the base part, which can reduce the non-coincidence error.

17.9 The parallelism between the Axis of Visual Alignment and the Axis of Emitting Electric Light

17.9.1 Check

1. Place the reflecting prism 50 meters from the instrument.
2. Use the telescope cross wire to precisely aim at the center of the reflecting prism.
3. Check whether the center of the telescope cross filament and the transmitting electro-optical axis alignment center coincide, such as the basic coincidence can be considered qualified.

17.9.2 Adjust

If the center of the telescope cross wire and the center of the transmitting electro-optical axis deviates greatly, it must be sent to the professional repair department for correction.

17.10 Non-prism Distance Measurement

The red laser beam, which is co-axial with the telescope and used for Non-prism distance measurement, is emitted from the telescope. If the instrument is well

calibrated, the red laser beam will coincide with the line of sight. External influences such as vibrations, large temperature changes, etc. can cause the laser beam to not coincide with the line of sight.

- Before precision distance measurement, the directional coaxially of the laser beam should be checked for any offset, otherwise it may lead to inaccurate distance measurement.

Warning

Looking directly at the laser is usually dangerous.

Prevention

Do not look directly at the laser beam, or shine it at others. Measurements may also be obtained by reflected light from the human body.

17.10.1 Check.

Place the reflective sheet with the gray side facing the instrument at 5 and 20 meters. Activate the laser pointing function. Aim at the center of the reflector sheet with the center of the telescope cross filament, and then check the position of the red laser dot. Generally, the telescope has a special filter so that the human eye cannot see the laser dot through the telescope. You can observe the degree of deviation of the red laser dot from the cross center of the reflector from above the telescope or the side of the reflector. If the center of the laser coincides with the center of the cross, it means that it is adjusted to the required accuracy. If the position of the dot deviates from the cross mark more than the limit, it needs to be sent to a professional maintenance department for adjustment.

- If the laser dot aim at the reflective surface too brightly, the white surface can be used instead of the gray surface to check.

Appendix A Symbol Meaning

Take the following example to illustrate the meaning of the symbols

Vz Zenith distance mode

V0 Vertical angle display mode of 0 when the telescope is horizontal at the positive mirror

Vh Vertical angle mode (0 when horizontal, positive elevation angle, negative pitch angle)

V% Slope mode

HR Horizontal angle (right angle)

HL Horizontal angle (left angle)

HD Horizontal distance

VD Elevation difference

SD Slant Distance

N North directional coordinates, dN denotes the difference of the stakeout N coordinates

E Eastern coordinates, dE denotes the difference of the stakeout E coordinates

Z Elevation coordinates, dZ denotes the difference between the stakeout Z coordinates

m In meters

ft In feet

fi In feet and inches, feet before the decimal point and hundredths of an inch after the decimal point

- X The value along the baseline direction in the point projection measurement, the direction from the starting point to the endpoint is positive
- Y Point projection measurement of the value in the direction of vertical deviation from the baseline
- Z The height of the target in the point projection measurement

